

See discussions, stats, and author profiles for this publication at: <https://www.researchgate.net/publication/280238901>

# The Biomechanics of the Baseball Swing

Thesis · May 2011

DOI: 10.13140/RG.2.1.1659.6325

---

CITATIONS

3

---

READS

734

1 author:



[Dave Fortenbaugh](#)

Engineering Systems, Inc.

14 PUBLICATIONS 267 CITATIONS

SEE PROFILE

2011-05-02

# The Biomechanics of the Baseball Swing

David Fortenbaugh

*University of Miami*, [davef@asmi.org](mailto:davef@asmi.org)

Follow this and additional works at: [http://scholarlyrepository.miami.edu/oa\\_dissertations](http://scholarlyrepository.miami.edu/oa_dissertations)

---

## Recommended Citation

Fortenbaugh, David, "The Biomechanics of the Baseball Swing" (2011). *Open Access Dissertations*. Paper 540.

This Open access is brought to you for free and open access by the Electronic Theses and Dissertations at Scholarly Repository. It has been accepted for inclusion in Open Access Dissertations by an authorized administrator of Scholarly Repository. For more information, please contact [repository.library@miami.edu](mailto:repository.library@miami.edu).

UNIVERSITY OF MIAMI

THE BIOMECHANICS OF THE BASEBALL SWING

By

David M. Fortenbaugh

A DISSERTATION

Submitted to the Faculty  
of the University of Miami  
in partial fulfillment of the requirements for  
the degree of Doctor of Philosophy

Coral Gables, Florida

May 2011

©2011  
David M. Fortenbaugh  
All Rights Reserved

UNIVERSITY OF MIAMI

A dissertation submitted in partial fulfillment of  
the requirements for the degree of  
Doctor of Philosophy

THE BIOMECHANICS OF THE BASEBALL SWING

David M. Fortenbaugh

Approved:

\_\_\_\_\_  
Shihab Asfour, Ph.D.  
Professor of Industrial Engineering

\_\_\_\_\_  
Terri A. Scandura, Ph.D.  
Dean of the Graduate School

\_\_\_\_\_  
Khaled Abdelrahman, Ph.D.  
Assistant Scientist, Industrial Engineering

\_\_\_\_\_  
Loren Latta, Ph.D.  
Professor of Orthopaedics

\_\_\_\_\_  
Arzu Onar-Thomas, Ph.D.  
Associate Member  
Department of Biostatistics  
St. Jude Children's Research Hospital  
Memphis, Tennessee

\_\_\_\_\_  
Glenn S. Fleisig, Ph.D.  
Research Director  
American Sports Medicine Institute  
Birmingham, Alabama

FORTENBAUGH, DAVID M.  
The Biomechanics of the Baseball Swing

(Ph.D., Industrial Engineering)  
(May 2011)

Abstract of a dissertation at the University of Miami.

Dissertation supervised by Professor Shihab Asfour.  
No. of pages in text. (235)

Success in baseball batting is fundamental to the sport, however it remains one of, if not the most, challenging skills in sports to master. Batters utilize the kinetic chain to transfer energy from the lower body to the upper body to the bat, hoping to impart the maximum amount of energy into the ball. Scientists and coaches have researched the swing and developed theories on the keys for successful batting, but most of this research has been inadequate in attempting to fully describe the biomechanics of batting. The purposes of this study were to improve upon the methodology of previous researchers, provide a full biomechanical description of the swing, and compare swings against pitches thrown to different locations and at different speeds. AA-level Minor League Baseball players (n=43) took extended rounds of batting practice in an indoor laboratory against a pitcher throwing a mixture of fastballs and changeups. An eight camera motion analysis system and two force plates recording at 300 Hz captured the biomechanical data. The swing was divided into six phases (stance, stride, coiling, swing initiation, swing acceleration, and follow-through) by five key events (lead foot off, lead foot down, weight shift commitment, maximum front foot vertical ground reaction force, and bat-ball contact). Twenty-eight kinematic measurements and six ground reaction force

measurements were computed based on the marker and force plate data, and all were assessed throughout the phases.

First, a comprehensive description of a composite of the batters' swings against fastballs "down the middle" was provided. Second, successful swings against fastballs thrown to one of five pitch locations (HIGH IN, HIGH OUT, LOW IN, LOW OUT, MIDDLE) were compared in terms of selected kinematics at the instant of bat-ball contact, timing and magnitude of peak kinematic velocities, and timing and magnitude of peak ground reaction forces. Third, these variables were once again compared for swings against fastballs and changeups. A large number of biomechanical differences were seen among the swings against various pitch locations. More fully rotated positions, particularly of the pelvis and bat were critical to the batters' successes on inside pitches while less rotated positions keyed successes against outside pitches. The trail and lead arms worked together as part of a closed chain to drive the hand path. Successful swings had the trail elbow extended more for HIGH IN and flexed more for LOW OUT, though batters often struggled to execute this movement properly. A distinct pattern among successful swings against fastballs, successful swings against changeups, and unsuccessful swings against changeups was witnessed; namely a progressive delay in which the batter prematurely initiated the events of the kinetic chain, especially when unsuccessful in hitting a changeup. It was believed that this study was much more effective in capturing the essence of baseball batting than previous scientific works. Some recommendations to batting coaches would be to get batters to take a consistent approach in the early phases of every swing (particularly for the lower body), identify both pitch type and location as early as possible, use the rotation of the pelvis to

propagate the energy transfer of the kinetic chain from the group to the upper body, and use the pelvis, and subsequently, the upper body, to orient the trunk and hands to an optimal position to drive the ball to the desired field. Limitations of the current study and ideas for future work were also presented to better interpret the findings of this research and further connect science and sport.



## TABLE OF CONTENTS

	Page
LIST OF FIGURES .....	vi
LIST OF TABLES .....	viii
Chapter	
1 INTRODUCTION .....	1
1.1 Background .....	1
1.2 Statement of the problem .....	3
1.3 Purpose and significance of the study .....	6
2 REVIEW OF LITERATURE .....	7
2.1 Biomechanical studies of the baseball swing .....	7
2.1.1 Kinematic studies of the baseball swing – Primitive technology .....	8
2.1.2 Kinematic studies of the baseball swing – Modern technology .....	12
2.1.3 Kinetic studies of the baseball swing .....	16
2.1.4 Electromyographic (EMG) studies of the baseball swing .....	20
2.2 Coaching and teaching the baseball swing .....	21
2.2.1 Charley Lau’s coaching philosophy .....	22
2.2.2 Ted Williams’ coaching philosophy .....	23
2.2.3 Coop DeRenne’s coaching philosophy .....	24
2.2.4 Teaching adjustments to pitch speed .....	26
2.2.5 Teaching adjustments to pitch location .....	26
2.3 Vision and cognition in batting .....	27
2.4 Physical tools and training of baseball batters .....	35
2.4.1 Strength, flexibility, and physical variables .....	35
2.4.2 Training programs .....	38
2.4.3 Weighted bats and warm-up swings .....	40
2.5 Bat properties and the bat-ball collision .....	42
3 METHODS .....	47
3.1 Participants .....	47
3.2 Instruments .....	47
3.3 Procedures .....	49
3.4 Data processing .....	51
3.5 Statistical analysis .....	54
4 RESULTS .....	58
4.1 Biomechanical description of the swing .....	58
4.1.1 Stance .....	58

4.1.2 Stride.....	58
4.1.3 Coiling.....	59
4.1.4 Swing Initiation.....	60
4.1.5 Swing Acceleration.....	62
4.1.6 Follow-Through.....	63
4.2 Analysis of swing biomechanics with changes in pitch location.....	65
4.2.1 Comparison of swings by pitch location.....	65
4.2.2 Relationships between biomechanical parameters and BEV.....	70
4.2.2.1 Lead knee flexion at BC.....	71
4.2.2.2 Pelvis rotation at BC.....	72
4.2.2.3 Upper trunk rotation with respect to the pelvis at BC.....	74
4.2.2.4 Lead shoulder elevation at BC.....	76
4.2.2.5 Lead shoulder azimuth at BC.....	77
4.2.2.6 Trail elbow flexion at BC.....	79
4.2.2.7 Bat lag at BC.....	81
4.2.2.8 Bat elevation at BC.....	83
4.2.2.9 Bat azimuth at BC.....	84
4.2.2.10 Head rotation at BC.....	86
4.2.2.11 Time of peak lead knee extension velocity.....	88
4.2.2.12 Time of peak pelvis rotation velocity.....	89
4.2.2.13 Time of peak upper trunk rotation velocity.....	90
4.2.2.14 Time of peak lead shoulder azimuth velocity.....	92
4.2.2.15 Time of peak trail elbow extension velocity.....	95
4.2.2.16 Time of peak bat azimuth velocity.....	97
4.2.2.17 Peak lead knee extension velocity.....	99
4.2.2.18 Peak pelvis rotation velocity.....	100
4.2.2.19 Peak upper trunk rotation velocity.....	102
4.2.2.20 Peak lead shoulder azimuth velocity.....	103
4.2.2.21 Peak trail elbow extension velocity.....	106
4.2.2.22 Peak bat azimuth velocity.....	107
4.2.2.23 Time of peak trail foot GRFx.....	109
4.2.2.24 Time of peak trail foot GRFy.....	110
4.2.2.25 Time of peak trail foot GRFz.....	111
4.2.2.26 Time of peak lead foot GRFx.....	112
4.2.2.27 Time of peak lead foot GRFy.....	114
4.2.2.28 Time of peak lead foot GRFz.....	115
4.2.2.29 Peak trail foot GRFx.....	117
4.2.2.30 Peak trail foot GRFy.....	118
4.2.2.31 Peak trail foot GRFz.....	120
4.2.2.32 Peak lead foot GRFx.....	122
4.2.2.33 Peak lead foot GRFy.....	123
4.2.2.34 Peak lead foot GRFz.....	125
4.3 Comparison of swings by pitch type.....	126

5	DISCUSSION .....	130
	5.1 Description of swing .....	130
	5.2 Modulation of swing to changes in pitch location .....	139
	5.3 Modulation of swing to changes in pitch type .....	144
	5.4 Limitations to previous and current research .....	148
	5.5 Conclusions .....	151
	5.6 Ideas for future work .....	153
	REFERENCES .....	155
	APPENDIX A: Informed Consent .....	162
	APPENDIX B: Diagrams of Kinematic Variables .....	164
	APPENDIX C: Motion Analysis Corporation Sky Scripts .....	176
	APPENDIX D: MATLAB Programming Codes .....	205
	APPENDIX E: Graphs of biomechanical data for the “typical” professional batter... ..	219

## List of Figures

Figure 1 American Sports Medicine Institute biomechanics lab setup .....	48
Figure 2a Anterior view of marker placement .....	50
Figure 2b Posterior view of marker placement .....	50
Figure 3 Lead knee flexion angle at BC across BEV (raw data) .....	71
Figure 4 Pelvis rotation angle at BC across BEV (raw data).....	72
Figure 5 Model estimate of average BEV across values of pelvis rotation angle at BC .....	73
Figure 6 Upper trunk rotation angle at BC across BEV (raw data).....	74
Figure 7 Model estimate of average BEV across values of upper trunk rotation angle with respect to pelvis at BC.....	75
Figure 8 Lead shoulder elevation angle at BC across BEV (raw data) .....	76
Figure 9 Lead shoulder azimuth at BC across BEV (raw data).....	77
Figure 10 Model estimate of average BEV across values of lead shoulder azimuth at BC .....	78
Figure 11 Trail elbow flexion angle at BC across BEV (raw data).....	79
Figure 12 Model estimate of average BEV across values of trail elbow flexion angle at BC.....	80
Figure 13 Bat lag angle at BC across BEV (raw data) .....	81
Figure 14 Model estimate of average BEV across values of bat lag angle at BC .	82
Figure 15 Bat elevation angle at BC across BEV (raw data).....	83
Figure 16 Bat azimuth at BC across BEV (raw data).....	84
Figure 17 Model estimate of average BEV across values of bat azimuth at BC ...	85
Figure 18 Head rotation angle at BC across BEV (raw data).....	86
Figure 19 Model estimate of average BEV across values of head rotation angle at BC .....	87
Figure 20 Time of peak lead knee extension velocity across BEV (raw data).....	88
Figure 21 Time of peak pelvis rotation velocity across BEV (raw data).....	89
Figure 22 Time of peak upper trunk rotation velocity across BEV (raw data).....	90
Figure 23 Model estimate of average BEV across values of time of peak upper trunk rotation velocity.....	91
Figure 24 Time of peak lead shoulder azimuth velocity across BEV (raw data) ..	92
Figure 25 Model estimate of average BEV across values of time of peak lead shoulder azimuth velocity at low PS.....	93
Figure 26 Model estimate of average BEV across values of time of peak lead shoulder azimuth velocity at medium PS.....	94
Figure 27 Model estimate of average BEV across values of time of peak lead shoulder azimuth velocity at high PS.....	94
Figure 28 Time of peak trail elbow extension velocity across BEV (raw data)....	95
Figure 29 Model estimate of average BEV across values of time of peak trail elbow extension velocity .....	96
Figure 30 Time of peak bat azimuth velocity across BEV (raw data).....	97
Figure 31 Model estimate of average BEV across values of time of peak bat azimuth velocity.....	98
Figure 32 Peak lead knee extension velocity across BEV (raw data).....	99

Figure 33 Peak pelvis rotation velocity across BEV (raw data) .....	100
Figure 34 Model estimate of average BEV across values of peak pelvis rotation velocity.....	101
Figure 35 Peak upper trunk rotation velocity across BEV (raw data) .....	102
Figure 36 Peak lead shoulder azimuth velocity across BEV (raw data).....	103
Figure 37 Model estimate of average BEV across values of peak lead shoulder . azimuth velocity at low PS .....	104
Figure 38 Model estimate of average BEV across values of peak lead shoulder . azimuth velocity at medium PS .....	105
Figure 39 Model estimate of average BEV across values of peak lead shoulder . azimuth velocity at high PS .....	105
Figure 40 Peak trail elbow extension velocity across BEV (raw data).....	106
Figure 41 Peak bat azimuth velocity across BEV (raw data) .....	107
Figure 42 Model estimate of average BEV across values of peak bat azimuth velocity.....	108
Figure 43 Time of peak trail foot GRFx across BEV (raw data).....	109
Figure 44 Time of peak trail foot GRFy across BEV (raw data).....	110
Figure 45 Time of peak trail foot GRFz across BEV (raw data).....	111
Figure 46 Time of peak lead foot GRFx across BEV (raw data).....	112
Figure 47 Model estimate of average BEV across values of time of peak lead foot GRFx .....	113
Figure 48 Time of peak lead foot GRFy across BEV (raw data).....	114
Figure 49 Time of peak lead foot GRFz across BEV (raw data).....	115
Figure 50 Model estimate of average BEV across values of time of peak lead foot GRFz.....	116
Figure 51 Peak trail foot GRFx across BEV (raw data) .....	117
Figure 52 Peak trail foot GRFy across BEV (raw data) .....	118
Figure 53 Model estimate of average BEV across values of peak trail foot GRFy	119
Figure 54 Peak trail foot GRFz across BEV (raw data).....	120
Figure 55 Model estimate of average BEV across values of peak trail foot GRFz	121
Figure 56 Peak lead foot GRFx across BEV (raw data) .....	122
Figure 57 Peak lead foot GRFy across BEV (raw data) .....	123
Figure 58 Model estimate of average BEV across values of peak lead foot GRFy	124
Figure 59 Peak lead foot GRFz across BEV (raw data) .....	125

## List of Tables

Table 1 Mean $\pm$ SD of kinematic angles at BC among the pitch locations .....	66
Table 2 Mean $\pm$ SD of timing of peak kinematic velocities among the pitch locations .....	66
Table 3 Mean $\pm$ SD of magnitude of peak kinematic velocities among the pitch locations .....	67
Table 4 Mean $\pm$ SD of timing of peak GRF among the pitch locations .....	67
Table 5 Mean $\pm$ SD of magnitude of peak GRF among the pitch locations .....	68
Table 6 Analysis of variance for lead knee flexion angle at BC .....	71
Table 7 Analysis of variance for pelvis rotation angle at BC .....	72
Table 8 Analysis of variance for upper trunk rotation angle at BC .....	74
Table 9 Analysis of variance for lead shoulder elevation angle at BC .....	76
Table 10 Analysis of variance for lead shoulder azimuth at BC .....	77
Table 11 Analysis of variance for trail elbow flexion angle at BC .....	79
Table 12 Analysis of variance for bat lag angle at BC .....	81
Table 13 Analysis of variance for bat elevation angle at BC .....	83
Table 14 Analysis of variance for bat azimuth at BC .....	84
Table 15 Analysis of variance for head rotation angle at BC .....	86
Table 16 Analysis of variance for time of peak lead knee extension velocity .....	88
Table 17 Analysis of variance for time of peak pelvis rotation velocity .....	89
Table 18 Analysis of variance for time of peak upper trunk rotation velocity .....	90
Table 19 Analysis of variance for time of peak lead shoulder azimuth velocity .....	92
Table 20 Analysis of variance for time of peak trail elbow extension velocity .....	95
Table 21 Analysis of variance for time of peak bat azimuth velocity .....	97
Table 22 Analysis of variance for peak lead knee extension velocity .....	99
Table 23 Analysis of variance for peak pelvis rotation velocity .....	100
Table 24 Analysis of variance for peak upper trunk rotation velocity .....	102
Table 25 Analysis of variance for peak lead shoulder azimuth velocity .....	103
Table 26 Analysis of variance for peak trail elbow extension velocity .....	106
Table 27 Analysis of variance for peak bat azimuth velocity .....	107
Table 28 Analysis of variance for time of peak trail foot GRFx .....	109
Table 29 Analysis of variance for time of peak trail foot GRFy .....	110
Table 30 Analysis of variance for time of peak trail foot GRFz .....	111
Table 31 Analysis of variance for time of peak lead foot GRFx .....	112
Table 32 Analysis of variance for time of peak lead foot GRFy .....	114
Table 33 Analysis of variance for time of peak lead foot GRFz .....	115
Table 34 Analysis of variance for peak trail foot GRFx .....	117
Table 35 Analysis of variance for peak trail foot GRFy .....	118
Table 36 Analysis of variance for peak trail foot GRFz .....	120
Table 37 Analysis of variance for peak lead foot GRFx .....	122
Table 38 Analysis of variance for peak lead foot GRFy .....	123
Table 39 Analysis of variance for peak lead foot GRFz .....	125
Table 40 Mean $\pm$ SD of kinematic angles at BC among the three trial types .....	126
Table 41 Mean $\pm$ SD of timing of peak kinematic velocity among the three trial types .....	127

Table 42 Mean $\pm$ SD of peak kinematic velocity magnitudes among the three trial types.....	127
Table 43 Mean $\pm$ SD of timing of peak GRF among the three trial types.....	127
Table 44 Mean $\pm$ SD of peak GRF magnitudes among the three trial types .....	128

## CHAPTER 1

### INTRODUCTION

#### 1.1 Background

As in most racquet/bat/stick sports, a baseball batter's objective is to deliver the maximum amount of energy possible at impact. This energy is then transferred to the ball, accelerating it to a high velocity (Adair, 2002). The trajectory and velocity of the batted ball are the primary contributing factors to the result of the hit. A batted ball with high velocity can result in one of at least two successful outcomes, depending on the ball's trajectory. With a lower trajectory, the result is a hard ground ball or line drive; these types of hits can more easily pass by the infielders or at least significantly decrease the chance of them being successfully fielded. If the trajectory of the ball is higher, the ball can land deep in the outfield for an extra-base hit or possibly go over the fence for a homerun. All of these results are quite favorable for the batter.

Energy is created by the batter through his utilization of the kinetic chain (Race, 1961; DeRenne, 1993). Linear and angular momentum are transferred from the ground up through the lower limbs, trunk, and upper limbs (i.e. the chain's "links") of the body. Each proximal segment passes its momentum to the connecting distal segment (e.g. upper arm to forearm to hand). To increase the resultant momentum, the muscles of the proximal segment provide an additional unique momentum before passing it to the next segment. In batting, the bat is gripped firmly at the hands, and the bat, in essence, becomes the final link of the kinetic chain. While the ultimate goal remains to maximize the linear and angular bat velocity, the kinetic chain theory clearly shows that each segment must do its part to contribute to the resultant bat velocity (DeRenne, 1993).



An essential component of the kinetic chain is the coordination, or timing pattern, of each of the links of the chain. Maximizing the velocity of each of the body segments is critical, but the transfer of momentum and energy can only be optimized if it is passed along at the right time (Feltner & Dapena, 1989). By transferring the energy too early or too late, the proximal segment is not travelling at its maximum velocity, reducing the total energy available to impart on the ball at contact. Further complicating the task for hitters is that incoming pitches are thrown by the pitcher with varying arm angles and speeds, creating a multitude of different potential planes of movement (Williams & Underwood, 1986). Hall of Fame pitcher Warren Spahn has famously been quoted as saying, “Hitting is timing. Pitching is upsetting timing.” In fact, the goal of an off-speed pitch, such as a changeup, is to fool the hitter by initially looking like a fastball, therefore upsetting his balance and timing when it arrives much later than anticipated (Baker, Mercer, & Bittinger, 1993; DeRenne, 1993). Adjusting the timing of the swing to the parameters affecting each pitch can often determine the result of the swing.

Literature involving baseball batting has generally fallen into one of two categories: coaching and scientific. One goal of this dissertation is to stretch the findings across both worlds, linking what coaches believe and teach with what scientists should measure and evaluate and vice-versa. Coaches have developed a prolific number of materials describing their philosophies on hitting (Baker, Mercer & Bittinger, 1993; DeRenne, 1993; Gola & Monteleone, 2001; Gwynn, 1998; Lau & Glossbrenner, 1984; Robson, 2003; Williams & Underwood, 1986). Unfortunately, this massive amount of information is often overwhelming, and it takes a keen eye to decipher the commonalities among the varying philosophies. The perfect example of this is seen between the ideas of

two of the most respected hitting teachers, Ted Williams and Charlie Lau. Williams preached the importance of rotation in hitting (Williams & Underwood, 1986), while Lau emphasized weight shift and the linearity of hitting (Lau & Glossbrenner, 1984). Ironically, both mentioned linear and rotational components of the swing in their books, signifying that successful hitters indeed must incorporate both linear and rotational movements. This irony indicates that scientific research is needed to confirm what these or any other coaches teach.

However, biomechanical data on hitting are somewhat limited. Early baseball swing analyses focused on simply defining the swing (Garhammer, 1983; Hirano, 1986). Welch et al. (1995) provided the first comprehensive biomechanical analysis of the baseball swing, though it was done with just seven hitters and all were right-handed and hit off of a tee. Newer studies have examined changes in swing mechanics off of a tee with variations in ball location (Tago et al., 2006a; Tago et al., 2006b). Other research has focused on a variety of specific subtopics such as the effect of grip strength on bat velocity (Hughes, Lyons & Mayo, 2004; Hirano & Murata, 2003), directional hitting (McIntyre & Pfautsch, 1982; Gelinas & Hoshizaki, 1988), and muscle activity during batting (Shaffer et al. 1993). Katsumata (2007) identified modulations in GRF patterns when batters swung at fast and slow pitches in a randomized order (similar to a game).

## 1.2 Statement of the problem

Batting is both a fundamental skill in the sport of baseball and yet one of its most challenging skills to develop. It is a complex, highly-coordinated multi-joint movement that requires an athlete to accurately strike a ball that can be thrown at different speeds

and to different locations with varying trajectories. Thousands of coaches have attempted to teach hitters how to develop this skill based on their own experiences and intuition (Baker, Mercer & Bittinger, 1993; DeRenne, 1993; Gola & Monteleone, 2001; Gwynn, 1998; Lau & Glossbrenner, 1984; Robson, 2003; Williams & Underwood, 1986). Very little scientific research has explored the mechanics of the swing to assess how the most successful athletes are able to execute this skill.

The majority of previous biomechanical research on the baseball swing has also had limitations in methodology. These limitations have confounded the results and threatened both internal and external validity. The most notable limitation has been that no biomechanical studies have observed the kinematics and kinetics of swings against live pitching. Instead, researchers have analyzed hitting off of a tee (Escamilla et al., 2009a,b; Hughes, Lyons, & Mayo, 2004; McLean & Reeder, 2000; Noble & Harms, 2004; Tago et al., 2006a; Tago et al., 2006b; Welch et al., 1995), against soft-toss (Hirano & Murata, 2003), and against pitching machines (Katsumata, 2007; McIntyre & Pfautsch, 1982) for convenience of testing. Coaching literature emphasizes that hitting against live pitching is ideal because it most accurately represents game situations (Robson, 2003). The methods used in the previous research disrupt or negate many of the temporal components of the swing that make successfully hitting a baseball the “single most difficult thing to do in sport” (Mihoces, 2003; Williams & Underwood, 1986). While tee and soft toss drills are noticeably different than live pitching, some may contend that the pitching machine is similar enough. However, coaches tend to disagree (Robson, 2003) and Jinji & Sakurai (2006) confirmed differences in incoming ball flight patterns between pitched baseballs and those fed through a pitching machine. Furthermore, testing of a

modified pitching machine that more closely simulated real-life pitching resulted in significantly better batting performance than a traditional pitching machine (Liu et al., 2005). The researchers of that study noted how batters are often confused by the unnatural timing of the ball's release by traditional pitching machines. Other deficiencies in methodology from the aforementioned biomechanical studies include the lack of variability in pitches (location, speed, and type) and in participants (anthropometrics, age and/or skill level, and handedness).

One final limitation is that while the Welch et al. (1995) study collected three-dimensional motion capture at 200 Hz, no other study has collected similar data at faster than 120 Hz. To illustrate how variability in frame rates affects data collection, one may notice that with distal-end linear bat velocities of at least 35 m/s (Nicholls et al., 2003), 200 Hz equates to at least 18 cm of distance travelled per frame, and 120 Hz equates to over 29 cm per frame. Higher frame rates can capture the "hidden data" that are lost in between frames or estimated when captured at lower rates. Baseball batting is such a dynamic and explosive movement that frame rates of 200 Hz should be the minimum capture frame rate. It is understandable that not all parameters can be included without exponentially complicating the data collection and analysis, but a more accurate and well-defined database needs to be developed to in order to model the baseball swing biomechanically. Understanding how batters adjust their swings to changes in pitch speed and location will give coaches and athletes insights on how to correct flaws and improve performance.

### 1.3 Purpose and significance of the study

The purposes of this study were to thoroughly describe the baseball swing biomechanically and subsequently analyze changes in batting mechanics with changes in pitch location and speed. A single protocol in which pitch speed and location were both manipulated by a batting practice pitcher was followed in order to independently address each of these two variations while more accurately representing a game situation. The development of an elite database of biomechanical data on professional hitters' swings against fastballs down the middle (the most common pitch type and location) will set the foundation for how to interpret flaws in less skilled hitters. Understanding the variability in swing mechanics with changes in pitch location will give insights on how batters must manipulate their standard mechanics when pitchers keep fastballs away from the middle of the plate and near waist level. Lastly, a comparison of successful swings against fastballs and changeups will showcase the adjustments batters make when correctly identifying the type of pitch thrown. Analysis of unsuccessful swings will be able to show the mechanical breakdowns that occur when batters identify the pitch too late and/or are unable to properly adjust their swing.

## CHAPTER 2

### REVIEW OF LITERATURE

This study was the first comprehensive attempt to biomechanically analyze baseball batters taking swings against live pitching. The first section of this literature review (2.1.1-2.1.4) will summarize previous biomechanical research studies of the baseball swing. While this first section is seemingly the most relevant to the current study, it is important to incorporate other approaches to studying baseball players and the skills required to hit a baseball. The second section (2.2) will review the philosophies of some well-known hitting coaches and discuss how they teach the fundamentals of hitting. The third section (2.3) will focus on scientific research studies of visual acuity and mental preparation of hitters. The fourth section (2.4) will explore the science behind the strength, conditioning, and physical make-up of baseball batters. The fifth and final section (2.5) will briefly examine some of the relevant research on bat properties and the physics involved in the collision between the bat and ball. Together, these five sections should encompass all of the critical aspects for being a successful hitter.

#### 2.1 Biomechanical studies of the baseball swing

Three of the major subdivisions of the field of biomechanics are kinematics, kinetics, and electromyography. As Winter (1990) defines it, kinematics simply describes human movement without regard to forces. These commonly include linear and angular displacements, velocities, and accelerations. The study of the forces that cause movement and the resultant energy is kinetics (Winter, 1990). Using a full kinematic description, anthropometric measurements, and external forces, joint reaction

forces and muscle moments can be estimated. To track muscle activity, one must study electromyograms (EMGs). These are the electrical signals associated with muscle contractions, and their study is referred to as electromyography (Winter, 1990). These three components of biomechanics have all been explored, to different extents, with baseball swings. The following subsections will review the findings in these three areas.

#### 2.1.1 Kinematic studies of the baseball swing – Primitive technology

The earliest biomechanical studies of the baseball swing were done as two-dimensional analyses of cinematographic film. Despite the limitations of using such technologies, some of the fundamentals of the swing were established scientifically. Race (1961) introduced the biomechanical principle of the kinetic chain to baseball batting and gave a general quantitative and qualitative analysis of the swing. Swimley (1964) found that the swing of a power hitter, who typically “pulls” the ball to the same side of the field as his batter’s box (left field for a right-handed hitter) had greater pelvis angular velocity than that of a hitter who tries to hit to all fields. Breen (1967) found five commonalities among outstanding Major League hitters: the center of gravity remains on a fairly level plane, head movements are adjusted from pitch to pitch to maximize ball tracking time, the leading elbow straightens at the beginning of the swing to increase bat velocity, the stride length is constant for all pitches, and after ball contact the upper body is pointed in the same direction as the hit with the weight shifted to the front foot.

In one of the first prospective biomechanical analyses, Hirano (1986) attempted to differentiate skilled hitters from unskilled hitters. Hitters were pitched balls while a 16 mm camera filming at 200 Hz placed approximately 10 m overhead recorded movements

in the horizontal plane. The skilled hitters demonstrated a rapid increase of linear bat velocity just before ball contact while the unskilled hitters' bat acceleration was more gradual. The skilled hitters were more efficient than the unskilled hitters, creating more mechanical energy (274 J to 228 J). This was further explained because the unskilled hitters had lower maximum pelvis angular velocity and extended their elbows and wrists earlier, which created a greater moment of inertia and slowed their bodies down more. This study was limited not only by the data collection method (one 16 mm camera filming at 200 Hz in the horizontal plane), but there were also only five skilled hitters and two unskilled hitters in this analysis.

Following Swimley's (1964) work, a pair of studies prospectively compared swings of same-field and opposite-field hitting. McIntyre & Pfautsch (1982) filmed 20 current or former college-level right-handed hitters. A college coach divided the two groups into "effective" and "ineffective" opposite-field hitters, and a pitching machine delivered balls to the hitters. Also filming in a horizontal plane, x- and y-coordinates of the bat, wrist, elbow, shoulder and ball were obtained, and displacement from the rear corner of home plate and angular orientations of the segments and joints of interest were calculated. Significant differences were found neither between effective and ineffective opposite-field hitters (i.e. skill level) nor in the interaction of skill level and field hit direction. However, significant differences were found between same-field and opposite-field hits. Same-field hits had significantly more movement time from initiation to ball contact, significantly more angular displacement of the bat, lead hand, and lead forearm at the instant prior to ball contact, and significantly less maximum angular velocity of the bat, lead hand, and lead upper arm. The researchers concluded that the batters adjusted



the amount of lead elbow extension and altered the orientation of the left wrist joint so that the bat was at an “appropriate orientation at the instant of ball contact.” Gelinas and Hoshizaki (1988) analyzed one Major League hitter rated as an “effective opposite-field hitter.” Balls were delivered at 120 km/h from a pitching machine while a camera filming at 200 Hz hung approximately 5m over the participant’s head as he hit. Results were calculated at the instant of ball contact. Supporting the findings of McIntyre & Pfautsch (1982), same-field hits required significantly more angular displacement of the bat (approximately 30° more), pelvis (approximately 14° more), upper trunk (approximately 11° more), and the angle between the bat and lead forearm (approximately 20° more). No differences were seen in the angles of the lead shoulder and elbow. Again, these studies were limited because of the use of 2-D cinematography and a pitching machine.

Timing and hand-eye coordination are a critical component to the success of a batter, especially because of the ability of the pitcher to change the speed and location of the ball. Matsuo, Kasai, & Asami (1993) did some preliminary investigations on the compensations hitters made when given a simulated hitting task randomized at two different velocities (130 km/h and 100 km/h). Using a series of LEDs aligned along a 15.5 m rail to simulate a pitched baseball, batters (n=9) swung while photocells captured the timing of the bat. Since no real ball was contacted, players were given feedback after every swing as to whether they were “early” or “late” and approximately how much. Baseline measurements were compared to data taken after a month of regular exposure to the testing procedure. Results between pre- and post-training sessions showed that the practice did lead to better performance, though no control group was assessed. It was

also noted that there was a faster adaptation to successfully time the slower velocity than the faster velocity. Beginning the swing earlier and then adjusting the movement time to the pitch speed seemed to be the best way to improve. Using the same simulated hitting task, Matsuo & Kasai (1994) further discovered that the first movement did not occur at different times despite changes in the simulated ball's velocity and that the movement time varied among trials of the same velocity of simulated balls. These researchers also confirmed that while there was some variability in the timing of early body and bat movements based on personal preference and style, the movements that occurred near impact that accelerated the bat to its maximum velocity were similar across all participants. Although these studies were limited because they were not studying actual batting, their findings also supported an anecdotal theory that all hitters, especially good hitters, have some unified underlying mechanism that enables them to successfully hit the ball despite a variety of stances and approaches.

Many variables can influence the bat's maximum velocity, and a few other studies using early biomechanics technology isolated a few of these factors for comparison: handedness, batting stance, and experience. McLean & Reeder (2000) studied 11 collegiate switch-hitters with one overhead camera recording swings off of a tee at 60 Hz in the transverse plane. Hand dominance was determined from a validated survey. No significant differences were found in bat speed or segment rotational velocities between dominant and non-dominant sides. LaBranche (1994) tracked the two-dimensional motions of the bat and the response times of 17 college hitters as they took swings off of a batting tee with their feet aligned in a closed, even, and open stance. No significant differences were found in bat velocity, but the response times for the closed and even

stances were significantly less, indicating that these stances produced faster swings than the open stance. As with previous research, both of these studies were also limited because of the video technology and the protocol of hitting off of a tee.

### 2.1.2 Kinematics studies of the baseball swing – Modern technology

A landmark study in the biomechanics of baseball batting was conducted in 1995 when Welch and colleagues were the first to use a three-dimensional motion analysis system to analyze the baseball swing. Collecting at 200 Hz, they tracked 23 markers placed on the body, bat, and ball of seven professional, right-handed hitters as they swung off of a batting tee. The X axis was in line with home plate and the pitching rubber while the Z axis was vertical, and the Y axis was their cross-product. Three line drives “up the middle” were analyzed for each participant, and the batting events of lead foot off, lead foot down, and ball contact were used as temporal markers. The kinematic variables measured were stride length and direction, flexion and extension at the elbows and knees, rotation of the pelvis, upper trunk, arms (a vector from the mid-shoulders to the mid-wrists), and a bat lag angle defined as the absolute angle between the longitudinal axis of the bat and the “arms” vector. A sequence of events was delineated to describe the rotational and linear loading and acceleration components of the swing starting with lead foot off (–570 ms relative to ball contact). The loading phase contained maximum pelvis rotation (18 degrees off the X axis at –350 ms), maximum upper trunk rotation (30° at –265 ms), and maximum arm rotation (150° at –230 ms). After the lead foot came back down (–175 ms) with a slightly closed (12°) stride of approximately 85 cm in length, there was a maximum pelvis rotation velocity (714°/s at –75 ms),

maximum upper trunk and arm rotational velocities ( $937^{\circ}/s$  and  $1160^{\circ}/s$  at  $-65$  ms, respectively), maximum Y and Z components of bat linear velocity ( $19$  m/s and  $16$  m/s at  $-40$  ms, respectively), maximum bat lag rotational velocity ( $1588^{\circ}/s$  at  $-20$  ms), and finally maximum bat linear velocity and maximum lead elbow extension velocity ( $31$  m/s and  $948^{\circ}/s$ , respectively, at  $-15$  ms). The X component of maximum bat linear velocity was achieved at  $-5$  ms while the maximum back elbow extension velocity was achieved at  $+5$  ms. This series of events gave solid evidence as to the existence of the kinetic chain in the baseball swing, as the summation of rotational components done in coordination generated the acceleration necessary to drive the bat through the hitting zone. While the researchers noted that the swings were performed off of a tee to eliminate variables such as the hitter's ability to recognize, react and adjust to pitched baseball, it is likely that this lack of realism, along with fairly low sample size, were the major limitations of the study.

The research by Dragoo (2004) advanced the knowledge of changes in biomechanics and neuromuscular control at different stages of development. Five cameras collecting at  $60$  Hz tracked reflective markers to calculate, among other variables, maximum pelvis rotation velocity (MPRV), maximum upper trunk rotation velocity (MUTRV), linear bat velocity (LBV), and ball exit velocity after contact (BEV) of hitters at one of three levels of experience: college, high school, and youth. The fastest bat and ball speeds were executed by the college group (MPRV =  $402^{\circ}/s$ ; MUTRV =  $539^{\circ}/s$ ; LBV =  $20$  m/s; BEV =  $57$  m/s). The high school group had slightly faster body segment rotational velocities but lower bat and ball speeds (MPRV =  $470^{\circ}/s$ ; MUTRV =  $581^{\circ}/s$ ; LBV =  $19$  m/s; BEV =  $48$  m/s). The youth group was significantly slower in all

velocities (MPRV = 302°/s; MUTRV = 402°/s; LBV = 15 m/s; BEV = 40 m/s). There were no significant differences reported in maximum bat angular velocities among college (1199°/s), high school (1233°/s), and youth (1151°/s) hitters. In a separate test, a non-significant trend of faster reaction time was seen from youth (315 ms) to high school (288 ms) to college (278 ms). The results of this study were limited by the capture frame rate since 60 Hz is fairly slow for such a dynamic movement as baseball batting.

A group of studies done in the mid 2000s (Tago, Ae, & Koike, 2005; Tago et al., 2006a; Tago et al., 2006b) focused on the biomechanical changes brought about by placing the ball in various pitch locations. Three-dimensional kinematics of 10 right-handed college hitters were calculated with a nine-camera motion analysis system collecting at 120 Hz. The ball was placed on a tee at random in one of the nine locations of the strike zone (low, middle or high crossed with inside, middle, or outside). At least five trials per locations were collected, with the “best” trial for each location selected for analysis. The researchers classified the phases of the swing, noting seven specific events: “take-back start” (-1200 ms to -1130 ms relative to impact), “toe-off” (-940 ms to -820 ms), “knee high” (-630 ms to -560 ms), “toe-on” (-240 ms to -210 ms), “swing start” (-220 ms to -180 ms), “left upper arm parallel” (-110 ms to -70 ms), and “impact”. There were no significant differences in ball exit velocity among inside, middle, and outside hits. At the instant of left upper arm parallel, inside pitches had significantly more back hip flexion, back knee flexion, and lead ankle extension. At impact, inside pitches had significantly less back hip abduction and more lead knee extension and lead ankle extension. There were significantly larger pelvis and upper trunk orientation angles (more open) on inside hits from the toe-on event through impact. Low balls had

significantly greater ball exit velocity than middle and high balls. From toe-on through impact high balls had significantly less back hip flexion than low balls. From swing start to impact high balls had significantly less lead hip flexion than low balls. Compared to low balls, at left upper arm parallel and impact high balls also had significantly more back shoulder flexion, less lead shoulder horizontal adduction, and less lead elbow extension. A significantly larger upper trunk orientation angle was also seen at impact on high balls compared to low balls. Unfortunately, no exact kinematic values were published in these studies (only graphs were presented). The studies were also limited by a low frame rate and use of only a batting tee.

Two studies published in 2009 (Escamilla et al., 2009a; Escamilla et al., 2009b) compared a group of right-handed adult hitters in two respects: once as a within-subjects test between normal and “choke-up” grips, and once as a between-subjects test against a group of youth hitters. Using two cameras recording at 120 Hz, machine-pitched balls were delivered to the batters from approximately 13.7 m at a speed of 32.6 m/s to 33.5 m/s (reduced to 28.2 m/s to 29.1 m/s for youths) for ten full-effort swings that had to have produced at least three hits that travelled at least 68.6 m towards left-center field. In the comparison of bat grips, the choke-up grip had a quicker stride and swing, a more open upper trunk and closed pelvis, and greater trail elbow extension velocity but significantly less linear bat velocity. When comparing youth and adult hitters, some notable differences were that the adults had significantly longer stride and swing phases, greater velocities of lead knee flexion ( $386^{\circ}/s$  to  $303^{\circ}/s$ ), lead elbow extension ( $752^{\circ}/s$  to  $598^{\circ}/s$ ) and upper trunk rotation ( $857^{\circ}/s$  to  $717^{\circ}/s$ ), and greater linear bat velocity (30 m/s

to 25 m/s). The researchers concluded that adults and youths had significantly different swing mechanics.

### 2.1.3 Kinetic studies of the baseball swing

The first known study of the GRFs experienced in baseball batting was done by Mason (1985), who tested the senior Men's Australian baseball team (exact number of participants not reported in study). The swing was divided into four phases: "waiting", "preparative hitting", "swing", and "follow-through". Force plates sampling at 100 Hz recorded swings against live pitching. In the waiting phase, it was reported that significantly more weight was placed on the front foot than the back foot (approximately 65% BW to 35% BW). Some batters (approximately 30%) remained fairly motionless while the rest (approximately 70%) had a distinctive "sway", or constant transfer of weight back and forth between the feet. The preparative hitting phase began at -800 ms to -400 ms relative to ball contact, with the front foot staying in the air for 150 ms to 300 ms and landing back on the ground at -300 ms to -200 ms before contact. During the swing phase, the back foot generated a maximum horizontal force of 30% to 50% BW, while the front foot generated 60% to 120% BW of horizontal force. A peak vertical force of two to two and a half times body weight was also generated by the front foot at -100 ms. This study had a number of limitations, though the most notable was a lack of synchronicity in kinematic and kinetic data to allow for accurate interpretation of the timing of events.

The descriptive biomechanical study by Welch and colleagues (1995) also included analysis of the ground reaction forces (GRFs), centers of pressure (COP) and

mass (COM) in baseball batting. With force plates under each foot sampling at 1000 Hz, component (X, Y, and Z axis) and resultant forces were measured at three points (foot off, foot down, and ball contact) during swings off of a tee. The X axis pointed from home plate towards the pitching rubber, the Z axis pointed up, and the Y axis was the cross product,  $Z \times X$ . As the front foot lifted off the ground, the batter shifted his weight to the back foot to about 862 N of total force, or 102% of body weight (BW). This was applied as 146 N of shear force in the negative X direction, 26 N in the positive Y direction, and 848 N in the negative Z direction. At this time the COP had shifted towards the right foot to a point 20 cm behind the COM. The front foot subsequently returned to the ground with a total force of 1007 N (123% BW), with 292 N of shear force in the positive X direction, 280 N in the negative Y direction, and 917 N in the negative Z direction. The back foot now supplied 497 N (58% BW) of total force (-80 N in X, +184 N in Y, and -438 N in Z), about half as much total force as the front foot. This weight transfer was also seen in a dramatic forward shift of the COP to a point 20 cm ahead of the COM. At ball contact, the front foot applied 709 N (84% BW) of total force (+153 N in X, +28 N in Y, and -672 N in Z) and the back foot applied 147 N (16% BW) of total force (+16 N in X, -1 N in Y, and -139 N in Z). The COP moved a bit more forward to be 24 cm ahead of the COM. A later study by Yanai (2007) also showed the GRF contributions from the legs, particularly the resistance provided by the front leg in order for the body to powerfully rotate against it.

Dragoo (2004) used force plate data collecting at 120 Hz to track the COP and neuromechanics of batters during swings against a pitching machine. Graphing XY scatter plots of COP to calculate distance travelled and velocity, response time was



recorded as the first spike in velocity after ball release. The number of spikes of acceleration (SOA) and the temporal location of the last spike (LOLS) were measured. Data were collected on youth, high school, and college hitters, and group comparisons were made. There were significant differences in response time and total excursion of COP in the X and Y directions (the X axis pointed from home plate to the pitching rubber), but not in the number of SOAs or the LOLS. College hitters had the longest delay in response time (198 ms), while high school hitters had an earlier initial reaction (190 ms), and the youth hitters were earlier still (177 ms). This longer viewing time purportedly gave college hitters more time to decide how to approach the ball. College hitters, compared to high school and youth, respectively, also had the greatest total COP<sub>x</sub> excursion (50 mm, 39 mm, 28 mm) and total COP<sub>y</sub> excursion (189 mm, 170 mm, 81 mm), indicating more weight transfer. This supports Welch and colleagues' (1995) work of a pronounced weight shift in order to generate bat speed and ball exit velocity.

Katsumata (2007) also used vertical GRFs to describe the “coordinative structure” in baseball batting. Right-handed college hitters (n=6) stood atop two force plates and swung at machine-pitched balls of two different speeds in three sessions. The first session delivered only “fast” pitches (approximately 32.2 m/s), the second session delivered only “slow” pitches (approximately 20.3 m/s), and the third session randomly delivered “fast” and “slow” pitches. The first two sessions were referred to as “Mono-pitch” conditions and the third was called “Mix-pitch” condition. Four events were defined by the researcher as “stepping”, “landing”, “swing” and “impact”. The results showed that temporal patterns of GRFs were similar across until task conditions except in between the time of landing and “weighting”, or shifting the weight to the front foot. The

time from landing to weighting was significantly longer in the Mix-slow condition (400 ms) and followed by Mono-slow (270 s), with no difference between the Mix-fast (60 ms) and Mono-fast (70 ms) conditions. This difference was identified as the control mechanism for adjustments made to pitch speed. Results also indicated that the time from swing to impact was significantly shorter on fast pitches, but that the swing time could still be modulated after the initiation of the swing. The researchers were also interested in determining the differences in successful and unsuccessful hits, but technological difficulties restricted them to analysis of successful swings only.

Only one study to date has looked at changes in GRFs with changes in pitch location (Fortenbaugh & Fleisig, 2008). College batters ( $n=9$ ) took five swings each off of a tee from the nine subzones of the strike zone previously discussed by Tago and colleagues (2006a; 2006b). With a force plate under each foot at sampling at 1250 Hz, the X axis pointed from home plate towards the pitching rubber, the Z axis was vertical, and the Y axis was their cross-product,  $Z \times X$ . Some statistically significant differences among pitch locations were reported, but the researchers concluded that since the magnitude of the changes was no more than 5% BW (roughly 50 N), the findings were clinically insignificant. An average timeline of the GRFs was reported. The front foot initially generated a push of 18% BW along in the negative X direction  $-1150$  ms relative to impact to load more weight onto the back foot. This weight then began to be transferred forward at  $-410$  ms with a back foot push in the positive X direction of 16% BW. Around  $-120$  ms, the feet stabilized the body in the Y axis with opposing forces (front foot  $-32\%$  BW; back foot  $+24\%$  BW). The initiation of the power to be transmitted through the kinetic chain came around  $-80$  ms from a peak front foot vertical force of

126% BW and GRFs in the X direction from both feet (front foot -39% BW; back foot +13% BW). This study, like others, was limited by its collection of data from swings off of a tee.

#### 2.1.4 Electromyographic (EMG) studies of the baseball swing

There are only a handful of known EMG studies on baseball swings. The first was carried out by Kitzman in 1964. He tracked the bilateral function of the pectoralis major, triceps brachii, and latissimus dorsi muscles in two professional players versus two novices. Limited results showed qualitatively that these muscles were engaged in the early part of the swing while other muscles (not measured) took over in the later part of the swing to drive the bat through the hitting zone. Another qualitative analysis of one unskilled batter by Broer and Houtz (1967) noted the importance of the abdominal muscles in stabilizing the trunk during the swing. A study by Kauffman & Greenisen (1973) on comparing muscle activity when using weighted and unweighted bats found no evidence that swinging weighted bats before at-bats in games was beneficial.

Shaffer and colleagues (1993) provided the most comprehensive and quantitative view of muscle activity during the swing. Fine wire electrodes recorded EMG signals of the lower gluteus maximus of the back leg and the supraspinatus, triceps, posterior deltoid, and middle serratus anterior of the lead arm during the live swings of 18 professional hitters. Surface electrodes were concurrently placed on the erector spinae and abdominal obliques, and vastus medialis obliques (VMOs), semimembranosus and biceps femoris of the back leg. As with many of the kinematic and kinetic studies, the researchers divided the swing into four phases: “windup”, “pre-swing”, “swing” (later

classified as early swing, middle swing, and late swing), and “follow-through”. The hamstring and gluteal muscles had high activity (as compared to values of a maximum muscle test, or MMT) during pre-swing and the early part of the swing phases, with values between 100% and 150% MMT. The VMOs contracted at roughly 95% to 110% MMT during the swing and follow-through. In the trunk, erector spinae activity ranged from approximately 85% to 185% MMT during the pre-swing and swing phases, while the abdominal obliques were over 100% MMT during the pre-swing, swing, and follow-through phases. In the upper body, the supraspinatus and serratus anterior muscles showed low activity (less than 40% MMT), while the posterior deltoid was most active (80% to 100% MMT) in the pre-swing and swing phases and the triceps was most active (over 90% MMT) in just the early part of the swing phase. It was concluded that the hamstring and gluteal muscles contribute to a stable base and drive the power thrust that uncoils the torso during the swing, while the sustained high activity of the trunk muscles suggested that they should be the focus of exercise and conditioning programs for hitters. It was believed that, contrary to popular beliefs, the upper extremity muscles were important for positioning the arms and hands rather than generating power with them.

## 2.2 Coaching and teaching the baseball swing

While little scientific research has been done on swing mechanics, there have literally been millions of coaches over the course of the 150+ years of baseball's existence, and they have generated countless ways to teach the mechanics of the swing. It is foreseeable that a significant amount of overlap exists in the concepts that coaches teach, and that different terminologies are used to describe these concepts. It is useful for

researchers to understand the language of coaches in order to interpret them into biomechanical terms and develop practical studies. The following is a brief summary of the key points of a few of the more legendary coaches of the last 50 years. Specific instructional points are also gathered and reported on the adjustments to pitch speed and location that coaches teach.

### 2.2.1 Charley Lau's coaching philosophy

Though never a successful professional player himself, many people respected Charley Lau as one of, if not the best, hitting coach of the second half of the 20<sup>th</sup> century. He published numerous materials advocating his teachings, and among them are his "10 Absolutes of hitting" (Lau & Glossbrenner, 1984). These are the concepts that Lau believes all good hitters share and need to continue to be successful. The first two Absolutes are to have a balanced, workable stance with rhythm and movement. The feet are parallel and shoulder-width apart, and the weight is distributed in such a way so that the hitter can move without falling over and can easily overcome the body's inertia. The third Absolute is to shift the weight forward from a firm, rigid back side to a firm, rigid front side, and the fourth is to have the hitter think about keeping his front toe closed, rather than opening it up to point towards the pitcher. These two Absolutes help create a solid stable base during the acceleration phase of the swing. After looking at thousands of hours of videotapes of the game's best hitters, Lau sees the fifth Absolute of hitting as getting the bat into the "launching position" when the front foot touches down. This means the top hand is at upper chest level and just off the rear tip of the back shoulder, and the bat is held at a 45° angle. The sixth and seventh Absolutes are more mental than

physical: a confident, focused, and aggressive attack when the pitch is delivered and a tension-free swing. These two concepts put the hitter in the proper frame of mind and give him a good attitude as he approaches each pitch in each at-bat. Lau believes the eighth Absolute, keeping the head “down” during the swing, is the most important of all of the Absolutes. By tracking the ball for as long as possible, the hitter is able to concentrate on exactly where to direct his swing. While Lau admits that what he really wants is for the head to stay stationary rather than actually moving down, he believes this cue seems to accomplish the goal more effectively. The ninth Absolute, using the whole field rather than trying to pull the ball over the fence every time, can quickly break down a hitter’s mechanics if not executed consistently. The tenth and final Absolute, a signature coaching tip of Lau, is to hit through the ball and “finish high,” that is to let go of the bat with the top hand after contact and have the bottom hand follow through up near head height. He teaches this to allow the lead arm to fully extend and to prevent the top hand from “rolling over” the bottom hand too soon.

### 2.2.2 Ted Williams’ coaching philosophy

While Charlie Lau was really known only as a batting coach, Ted Williams transitioned from one of the greatest hitters of all-time into a highly-respected hitting coach. In his book, “The Science of Hitting” (Williams & Underwood, 1986), Williams blended his experiences as a coach and player with the fundamentals that he would teach to other hitters. Williams preached “self-education”, recognizing that a hitter needs to learn from each at-bat, knowing situations, and knowing his own strengths and weaknesses. Williams saw himself as a very “hands-off” type of coach, only

occasionally making small suggestions on mechanics while mostly letting the hitters make their own adjustments. He believed each hitter had to naturally adapt his swing to his body size and strength. Most of Williams' corrections were about the mental approach: what pitches to swing at and when; and how to recognize different pitches. His three rules were to "get a good pitch to hit", think properly prior to an at-bat using the information learned from previous experiences with the current pitcher and similar ones, and to "be quick with the bat." As for mechanics, Williams was not opposed to variability in just about every facet of the swing, from different stances with the feet, to hand, arm, and bat position. However, the most important mechanical detail he preached was to have a slight backward hip-cock followed by a powerful forward hip rotation into the ball. This, he said, is where the real power is generated, while the wrists, forearms, and hands then contribute very little, and merely passing the energy along through the bat.

### 2.2.3 Coop DeRenne's coaching philosophy

Unlike Lau and Williams, Coop DeRenne's background has been rooted more in academia, and he has used science to study and teach hitting mechanics. One very important thing that DeRenne noted in his famous text "High Tech Hitting: Science vs. Tradition" (1993), is the issue of semantics: each coach may have unique vocabulary, so two can describe the same thing quite differently, often leading to misinterpretations by the hitters. As well, coaches often tend to emphasize one component of the swing and neglect others, and DeRenne insisted on treating all parts of the swing as equally important. While DeRenne noted that most people know Charlie Lau as a proponent of

weight transfer (linear motion) and Williams as a proponent of rotation, DeRenne's research consistently showed that hitting is "a fluid sequential motion involving two movements working in tandem – straight forward or linear and then angular or rotation."

DeRenne's research also led to the development of his four biomechanical absolutes: dynamic balance, the kinetic link (*i.e.* kinetic chain), bat lag, and rotation. Good dynamic balance means having the body's center of gravity between the feet, not entirely on one foot or the other, throughout the whole swing. Hitters should end their weight shift as the front foot lands and begin rotating against a firm front side. By not continuing to drift forward, the hitter can better keep his head focused on tracking the incoming pitch. As the pitch comes in, an ideal kinetic chain will produce high bat velocity by transferring energy from the strong body segments (the legs and trunk) to the proportionally smaller and faster moving arms and to the bat. While he believed that the hands are important for initiating the swing and stabilizing the bat, DeRenne asserted that the hands and forearms simply cannot contract fast enough during the ballistic movement of the swing to contribute much unique energy to the kinetic chain. As the bat moves from the "launching position" to ball contact, the hitters' hands should take the knob of the bat directly towards the ball, which pushes the hands ahead of the barrel of the bat and creates "bat lag". Once the hands are in this forward linear position, the wrists should snap the bat through a 90 degree arc to the contact area. While the hands are coming through, the body should turn about the "axis of rotation." This is an imaginary vertical line that, when balanced, passes through the head, center of gravity, and equidistant between the feet.



#### 2.2.4 Teaching adjustments to pitch speed

Hitters must constantly be aware of the full repertoire of pitches that an opposing pitcher may deliver and make adjustments to their swing accordingly. The most common way to teach hitters how to adapt their swing to different pitch types is to prepare for a fastball and then react to an off-speed pitch (Baker, Mercer, & Bittinger, 1993; Gwynn, 1998). Discerning the direction of the spin on the ball can help identify the pitch, as different pitch types have unique spin (Baker, Mercer, & Bittinger, 1993; DeRenne, 1993). If an off-speed pitch is detected, the hitter needs to consider how that pitch will move and anticipate the ball's horizontal and vertical location when it passes through the hitting zone, not its location when it is first identified (Baker, Mercer, & Bittinger, 1993; DeRenne, 1993). It is also highly recommended for hitters to watch the pitcher during warm-ups before the game and in between innings to gain a better understanding of that pitcher's repertoire. Hitters should try to think along with the pitchers as to what pitch is coming rather than purely guessing (Baker, Mercer, & Bittinger, 1993). Coupling the knowledge of the pitcher's strongest and weakest pitches with pitching tendencies based on counts should prepare the hitter well for each pitch of his at-bat (Williams & Underwood, 1986).

#### 2.2.5 Teaching adjustments to pitch location

Just as with changes in pitch speed, pitchers like to throw the ball inside and outside and high and low to further challenge hitters, and hitters must also make adjustments to these pitch locations. Coaches universally agree that it is ideal to "hit the ball where it's pitched," or pull the inside pitches to the same field and hit the outside

pitches to the opposite field. To properly align the bat angle and create the most powerful swing, coaches suggest hitting inside pitches a few feet out in front of the plate, while outside pitches should be hit as the ball crosses the back half of the plate (Gola & Monteleone, 2001; Lau & Glossbrenner, 1984). Hitters are told to pull the knob of the bat towards the ball so that the appropriate changes are made to the bat angle at contact (Robson, 2003). This brings the hands closer to the body on inside pitches and further away on outside pitches (DeRenne, 1993). On inside pitches, the elbows will usually not lock out though they are still in a powerful position (Baker, Mercer, & Bittinger, 1993). Since most hitters struggle much more with outside pitches, some coaches even recommend looking for the outside pitch and allowing the body to naturally react to the inside pitch (Gwynn, 1998). Regardless of pitch location, coaches agree that hitters should stride directly towards the pitcher on every swing since they must commit this action before recognizing where the pitch will end up (DeRenne, 1993; Williams, 1986). When looking at high and low pitches, Robson (2003) advises to keep the same posture throughout the swing and make as few changes as necessary to get the bat to the ball. Bending the knees on low pitches and “chopping down” on high pitches are not recommended.

### 2.3 Vision and cognition in batting

While some sports, such as weightlifting, swimming, and running, do not require much sensory perception, evaluation, and reaction during their movements, hitting a baseball is considered by many to be more challenging mentally than physically. One of the witticisms attributed to baseball legend Yogi Berra contends that “90% of hitting is

mental; the other half is physical” (Berra, 1998). Some truth to this appeared in an ESPN expert panel ranking of 60 sports across 10 categories to determine the most difficult (Page 2 - Sports skills difficulty rankings). While baseball was ranked highly in a number of physical categories (9<sup>th</sup> in “power”, 9<sup>th</sup> in “agility”, and 15<sup>th</sup> in “speed”), it was ranked 1<sup>st</sup> overall in hand-eye coordination and 15<sup>th</sup> in “analytical aptitude”.

Before examining how baseball players react in various batting tasks and training programs, it may be wise to discover the mental approach hitters have before they even step into the batter’s box. McPherson (1993) allowed college baseball players (“experts”) and regular college students (“novices”) to view a half-inning of a college baseball game. When placed in a simulated environment of being the fourth batter up that inning and asked to think aloud, there was no difference in the amount of information given by the expert and novice participants, but there was a significant difference in the quality and type of information given. The experts gave much more detailed analyses of the pitcher and the previous batters, including pitch counts and pitch types. While the novices were aware of certain situations, they were often unable to explain what specific information was needed in order to achieve a goal. McPherson and MacMahon (2008) later focused their research on the tactical knowledge required for successful batting. Similar results were seen of the experts focusing attention to specific details that would aid them during their own at-bat, specifically information about the pitcher’s strengths and weaknesses, velocity, and pitch tendencies. However, it was also discovered that by instructing the participants to recall as much information as possible, irrelevant information about game conditions was often recalled while relevant information about intended actions and goals was not mentioned. The researchers recognized the

importance of concurrently developing tactical batting skills along with motor batting skills for success in baseball batting.

While these previous studies have laid some groundwork into a batter's psyche, the results of simulated batting tasks, controlled laboratory experiments, and observations of game participation give a more complete understanding of vision, perception, motor learning and control, and the overall mental approach hitters have during batting.

Hubbard & Seng (1954) first observed that batters tracked pitched baseballs using pursuit movements of the eyes with the head fixated, though the tracking stopped while the ball was still 2 m to 5 m from home plate. It was unclear, however, whether the cessation was voluntary (information no longer useful) or involuntary (eyes incapable of tracking high velocity at close distance). It was long thought that batters, especially adept ones, could decide whether to swing and how to approach an incoming pitch "just a few feet" before the pitch arrived at home plate. Slater-Hammel & Stumpner (1950) first quantified the simple reaction time (average = 210 ms) and movement time (average = 270 ms) of experienced recreational batters. Since the flight of a ball from the pitcher's hand to home plate takes roughly 400 ms, this was evidence that batters need to move earlier than was previously thought. Realizing that batting involves choice reaction and movement time rather than simple reaction time, the researchers repeated their experiments (Slater-Hammel & Stumpner, 1951) to incorporate the element of choice and observed even slower times (290 ms and 340 ms, respectively). Factoring in the time it takes to move the bat through the hitting zone, it was purported that hitters must start their movements much earlier, perhaps even before the ball is released.

The work of Paull & Glencross (1997) used a pair of experiments to target what information elite batters use and when during the skill the information is acquired. In the first experiment, expert and novice batters were placed in a simulated batting environment and viewed tapes of pitches. A strain gauge was wrapped around a baseball bat, and batters squeezed the handle as soon as they believed they knew where the pitch would cross home plate. They were also asked to point out exactly where it would cross in relation to a gridded strike zone. Results showed that experts decided on pitches significantly earlier than novices (460 ms to 570 ms, respectively) and were significantly more accurate in their estimation of the pitch's ultimate location. For half of the trials, they were given a game scenario in order to provide context and facilitate their decision-making process, as it was hypothesized that experts would benefit more from this due to their knowledge and experience. Knowing the game scenario beforehand significantly improved the ability of the batters to guess earlier and more accurately, though the trend was seen in both experts and novices rather than just in experts. In the second experiment, the video clips were edited so that the pitcher was occluded from one of five different points during the pitch (80 ms before ball release, ball release, 80 ms after ball release, 160 after ball release, and 240 ms after ball release) through the end of the pitch. Results of this experiment were inconclusive, but it was noted that the amount of location guessing errors early in the pitch was higher in curveballs compared to fastballs. This supports that anecdotal theory that the flight of a curveball is more unpredictable.

To further differentiate skilled and unskilled hitters, Castaneda & Gray (2007) tested batters in a simulated batting environment with one of four dual-task conditions that directed attention at skill execution (hand movement and bat movement) and the

environment (auditory tones and the ball leaving the bat). The skilled batters performed significantly better when focused on the environment than on the skill, while the unskilled batters had the exact opposite result. This led the researchers to conclude that while skilled batters have internalized knowledge of the skill of hitting that performs best when uninterrupted, unskilled hitters need to focus on “step-by-step” execution of the swing in order to be successful.

Using the Markov mathematical model to analyze batting cognition as a stochastic process, Gray (2002a) attempted to numerically capture some of the phenomena involved in the thought processes in hitting. It was assumed that since batting requires the perception of such a large amount of information in such a short amount of time, it would behoove batters to try and find patterns of pitching and base decisions about when and where to swing on pitch history. In the experiment, pitches were shown on a screen as an incoming ball, and the batters ( $n=6$ ) swung a bat with an affixed motion tracking sensor to detect contact. Pitch counts changed with the result of each pitch, and incoming pitch speed and location was varied to match the real-life probabilities associated with the given pitch counts. The results of this model supported anecdotal theories that high level hitters typically expect fastballs and adjust to off-speed pitches rather than purely guessing pitch types. The model also reflected things such as hitters being “fooled” by an off-speed pitch following a series of fastballs and the shift in advantage between the pitcher and hitter depending on the count. There were also significant differences among playing levels, suggesting the use of the model as a comparative tool when assessing hitters.

Gray (2002b) also conducted a series of experiments in a virtual hitting environment to study how the different elements of a pitch (speed, location, ball rotation, and sequence/history) are perceived and how they influence a batter's swing. Temporal and spatial swing accuracies were used as the measures of batting success. The first experiment tested batting against a wide variety of pitch speeds. Results showed that when pitches are thrown completely at random (i.e. without regard to pitch count or pitch history), batters struggled to make contact. They had particularly low spatial accuracy, which the author attributed to an inability to estimate pitch height at ball contact. In the second experiment, only fastballs and changeups were thrown. The hitters fared significantly better against two pitch types than when facing a random assortment of pitch speeds, emphasizing the fact that most pitchers need to throw at least three distinct pitches (e.g. fastball, curveball, and changeup) in order to disrupt the hitters' timing. Still, batters in this experiment struggled with a change in speed after seeing the same speed for multiple pitches and occasionally had large spatial and temporal errors. The large errors were typically appropriate swings for the opposite pitch type (e.g. a "fastball swing" for a changeup). The third experiment adjusted the probability of a fastball or changeup depending on the pitch count, with fastballs coming more frequently when the hitter was ahead in the count and changeups when the hitter was behind in the count. Consequently, hitters had significantly better temporal and spatial accuracy when adjusting pitch type expectations based on pitch count. The fourth and final experiment analyzed the ability of hitters to interpret the direction of the spin on the ball, as fastballs have "backspin" and curveballs have "topspin". Some hitters performed better when able to pick up rotation direction cues as was first suggested by Hyllegard (1991), though

there was a limitation because the frame rate of the video pitch simulation was slower than a real-life baseball spinning. In general, this study scientifically backed several theories proposed by hitters and coaches over the years, though it was also quite limited because the testing involved simulated batting tasks rather than batters facing real live pitching.

Scott & Gray (2007) made a very interesting finding when studying different batting practice regimens. In one of three different 45-pitch practice conditions, experienced hitters had simulated pitches delivered at the same speed but at different heights (one df - spatial), the same height but at different speeds (one df - temporal), and different speeds and heights (two df). Spatial and temporal swing accuracies were used as measures of performance. Following the practice conditions, all batters completed a two df 45-pitch condition to simulate game conditions. Batters who practiced in the one df - spatial condition did significantly worse in the test condition than those who practiced in the two df condition, while there was no significant difference during the test condition between batters who practiced in the one df – temporal and two df conditions. These results go against the common technique of holding pitch speed constant during pre-game batting practice, suggesting that this may actually hinder performance in games. However, interpretation of these results is also limited because of the use of a batting simulator rather than live pitching.

A few studies have advanced past simply testing hitters to understand their weaknesses and strengths in vision and cognition and tried to implement training programs to improve batting performance. Burroughs (1984) incorporated a training tool known as the Visual Interruption System (VIS) in a pair of training experiments. The



VIS device blocked the vision of the hitter after viewing approximately 4 to 6 m of ball flight. Training groups watched films of “learning trial” pitches with feedback, as these were designed to help batters recognize a variety of pitch types, speeds, and locations. All participants (control and training) were then post-tested with the VIS and asked to identify the location (and/or type, if necessary) of the pitch, and their responses were cross-referenced with official umpires for accuracy. In general, participants had difficulty in determining the location of a pitch after such a short viewing time (40-50% accuracy), though they were very good at distinguishing fastballs from breaking balls in that time (90% accuracy). The training groups scored significantly better than the control groups (55% to 43%). It was also discovered that the gains made in visual simulation training could be maintained six weeks after training.

Cassidy & Wade (1998) tested the effects of a week-long video training session on choice reaction time (CRT) in novice baseball batters. A test group and training group were each given a pre-test of viewing 10 live pitches while standing in the batter’s box and were asked to press one of two buttons to indicate, as soon as possible, whether a fastball or curveball was being delivered. Training involved discussions on the general pitching kinematics of fastballs and curveballs, common visual search strategies of expert batters, and several videotapes of practice trials. The same 10-pitch protocol was repeated in the post-test, and results indicated that while there was a slight, yet statistically insignificant improvement in the number of correct answers, the participants in the video training group had significantly faster CRTs following their training. The researchers cautioned, however, that the results were probably not clinically significant, improvement was not as uniform as expected, and that a general training effect, rather

than one specific to video training, had occurred. Researchers were also unclear as to the potential effect of video training on expert batters.

## 2.4 Physical tools and training of baseball batters

It is evident that baseball players need the proper mental approach, good coaching, and efficient biomechanics in order to excel as a hitter, but the physical condition of a player is the basis for his ability to generate a powerful swing. As in nearly all sports, there is a balance between technique and raw physical ability, and a number of research studies have examined the latter from several different points of view. The following subsections will summarize research on the anthropometric characteristics and physical assessments of baseball players and various training programs designed to improve hitters' strength and conditioning. A special focus will also review articles written on the effects of differently weighted bats and warm-up swings taken before at-bats.

### 2.4.1 Strength, flexibility, and physical variables

Physical characteristics such as height, mass, body composition, and somatotype of 132 college baseball players were evaluated by Carda & Looney (1994) to determine if differences existed among baseball positions at that level. With regard only to position players, there were no significant differences between infielders and outfielders in any of the measured parameters, including height (180 cm to 179 cm, respectively), mass (79 kg to 78 kg), and body fat (13% to 12%). When differentiating by individual infield positions, first basemen were significantly taller than third basemen and second basemen

(185 to 178 and 175 cm, respectively), and shortstops were also significantly taller than second basemen (182 to 175 cm). First basemen and catchers had significantly more mass than second basemen (85 kg and 81 kg to 71 kg, respectively). The researchers were unsure whether their findings were because coaches specifically recruit players at a given position to match these body types or because the players best suited to play these positions naturally had such body types.

Another comparison among baseball positions was made by Coleman & Lasky (1992) when they assessed running speed and body composition in 210 professional baseball players. All position players had relatively the same average height (179 to 183 cm) and body fat (8% to 10%), but catchers were found to be significantly heavier than infielders and outfielders (91 to 83 and 85 kg, respectively). In a 55 m (60 yard) sprint, a common testing distance for baseball, catchers were significantly slower (7.19 s) than infielders (6.97 s) and outfielders (6.89 s). The researchers intimated that catchers would benefit from an explosive training program that brought them closer to the infielders and outfielders in body composition and running speed. Since baseball players usually only need to make a few quick forward and lateral steps, it was also recommended that alternatives to the long sprint be used when assessing running speed, acceleration, and explosiveness.

While a number of studies looked at overall characteristics, Hills (2005) specifically measured the hip range of motion (ROM) in 41 high school and college hitters to verify any asymmetries in ROM due to the unilateral motion of batting. There were no significant differences in hip internal rotation between the back and lead hip, but hip external rotation and total ROM was significantly greater in the back hip. It was

believed that this imbalance was due to the motion of batting, but a biomechanical analysis of the swing was not performed in order to corroborate this belief.

In addition to flexibility, functional strength is important in athletes because it translates their ability to apply raw strength towards a specific goal. In the case of baseball players, this can be measured as how certain strength parameters affect joint kinematics and bat velocity. Thwaites (2005) noticed that left elbow flexion isometric strength of right-handed batters significantly correlated with linear horizontal bat velocity. Weimer, Halet & Anderson (2007), however, found no correlations in college baseball players between bat velocity and one repetition maximum strength measurements of hand grip, trunk rotation, triceps push downs, biceps curls, and bench press. The researchers then suggested implementing exercises that would be more baseball-specific and incorporate the power and explosiveness seen in batting.

A battery of physical fitness tests was conducted by Kohmura et al. (2008) to see how they correlated to playing performance evaluations in batting, fielding, and running. College baseball players (n=43) were tested on throwing distance, back strength, medicine ball overhead throwing, standing long jump, T-test of agility, and baserunning. When controlling for fielding and running ability, significant partial correlations were seen between batting ability and medicine ball throwing ( $r = 0.57$ ), and back strength (0.50). These two physical tests require good core muscular strength and power, and the researchers concluded that these tests would be good both for assessment and training.

### 2.4.2 Training programs

A survey of all 30 Major League strength and conditioning (S&C) coaches (Ebben, Hintz, & Simenz, 2005) provided solid background information on the elements of a professional baseball player's workout program. Off-season strength/power development workout programs were typically four days a week for 45-60 minutes, while in-season strength power development workout programs were typically two days a week for 15-30 minutes. All 21 coaches who responded to the survey reported incorporating some kind of flexibility training. This included exercises in dynamic flexibility (81%), proprioceptive neuromuscular facilitation (71%), and ballistic stretching (19%). Plyometric exercises were part of the routine for 95% of S&C coaches, with 81% using it to increase lower body power and 48% using it to increase upper body power. Only 14% of S&C coaches employed Olympic-style weightlifting exercises. Overall, squats and lunges were identified as the most important exercises used in training.

Though S&C practices generally appear to be as cyclical in nature as fashion, a focus on the development of lower body strength and power for baseball batters is evident from the results of the previous study, as well as other research that has looked specifically at lower body training regimens. Rhea and colleagues (2008) trained two groups of college baseball players, one with cardiovascular endurance training and one with speed/speed endurance training, and compared them using validated vertical jump tests for power before and after their competitive seasons. There was a significant difference between groups; the endurance training group showed a 3% decrease in power output, while the speed group showed a 15% increase in power output. Dodd & Alvar (2007) attempted to further explore lower body power training by comparing a

counterbalanced rotation of four week programs of resistance training, plyometrics, and “complex training”, which combined the two modalities. Pre- and post-training measures of short sprinting, vertical jumps, standing broad jumps, and a T-test of agility were performed after every four week session, with a week of active rest in between each four week block. Positive changes were reported for all three types of training. However, no significant differences among groups were detected.

To analyze the effect of medicine ball training on high school baseball players, Szymanski and colleagues (2007a) added rotational and full-body medicine ball exercises to a periodized resistance training program to one of two groups over a 12-week period. Both the control and training groups showed significant increases over the 12 weeks in dominant and non-dominant torso rotational strength, “medicine ball hitter’s throw”, parallel squats, and bench press, but the training group improved significantly more than the control group in torso rotation strength and hitter’s throws. The transfer effect was also studied (Szymanski et al., 2007b) by measuring linear bat-end velocity (BEV), pelvis angular velocity, upper torso angular velocity, and linear hand velocity. Again, both groups showed improvement, but a significant interaction of group and time demonstrated the beneficial effects of medicine ball training as the training group improved more than the control group in BEV and pelvis and upper torso angular velocity.

Besides core strength, many pundits also believe that hitting success requires strong forearms and wrists. Szymanski et al. (2004) showed that additional wrist and forearm training did result in increased wrist and forearm strength for high school baseball players after implementing a 12-week program. Hughes, Lyons, & Mayo (2004)

further tested this by establishing a baseline relationship between grip strength and bat velocity and then determining whether a grip strengthening program would affect bat velocity. College baseball players (n=23) were divided into two groups, control and experimental. Both groups completed resistance training exercises as part of a normal training regimen, but only the experimental group did additional forearm and grip strengthening exercises during a 6 week period. No significant correlations were seen between grip strength and bat velocity, and while there were significant increases in bat velocity, the increases were similar for both groups. The researchers concluded that additional training of the forearms and wrists to improve bat velocity may not be necessary. Szymanski and colleagues (2006) had a very similar finding in a 12-week training study that incorporated wrist and forearm exercises. Bat velocity improved, but there was no difference between groups, indicating no specific effect of the wrist and forearm exercises on performance.

#### 2.4.3 Weighted bats and warm-up swings

It is still very common to see batters standing in the on-deck circle warming up by swinging a weighted implement, but the scientific merit of such activity has been disputed. DeRenne (1992) was one of the first to measure the effects of warming up with weighted implements on bat velocity. High school baseball players (n=60) swung 13 different warm-up implements on separate days. The warm-up implements that led to the greatest bat swing velocity during testing were within 10% of the game bat weight. Surprisingly, warming up by swinging a bat with a “donut”, one of the most common methods of warm-up, resulted in the lowest bat velocity during testing. Otsuji, Abe, &

Kinoshita (2002) also found a significant decrease in bat velocity when warming up with a bat donut. Southard & Groomer (2003) tested the use of warm-up bat donuts on 10 experienced baseball players, and again confirmed significantly lower bat velocities and joint linear velocities when warming up with a bat donut compared to warming up with a normal bat only. Ironically, a study by Otsuji, Abe & Kinoshita (2002) also measured perceived swing velocity and heaviness, and the batters actually thought the normal bat felt lighter and was swung faster following warm-ups with a bat donut. It is evident that there is no biomechanical advantage to warming up with a weighted implement, but it is possible that there is a beneficial psychological effect.

A pair of studies looked at the effectiveness of a training protocol using weighted bats to improve bat swing velocity. Sergio & Boatwright (1993) assigned college baseball players (n=24) to one of three groups to take 100 dry swings three times a week for six weeks: a control group that used only a legal game bat, a heavy bat group that trained with a bat twice as heavy as a legal game bat, and an alternating group that switched back and forth every five swings between the heavy bat and a lightweight “fungo” bat. Within each group there was a significant increase in bat speed of around 8.5% after six weeks, but there was no difference among groups. This indicated to the researchers that using the documented protocol and swinging a bat of any weight would significantly improve bat swing velocity. DeRenne and colleagues (1995) later divided 60 college baseball players into live batting practice (BP), dry swing (DS), and control groups. The BP and DS alternated in a progression from heavy (0.88 to 0.94 kg) to light (0.77 to 0.82 kg) to standard (0.85 kg) bats every 10 swings for 150 swings four days a week for 12 weeks, while the control took an equal number of swings with only a standard bat. A significant



increase was again seen within each group after the 12 week period. However, there was also a significant effect between groups, showing that the BP group benefited significantly more than the DS group, and the DS group benefited significantly more than the control group. This result concurred with the previous research (DeRenne, 1992) that postulated the beneficial effects of using a weighted bat as long as its weight is kept close to the standard game bat weight.

## 2.5 Bat properties and the bat-ball collision

A number of biomechanical studies have investigated various characteristics of the ball, the bat, and the interaction between the two. This section will focus only on the bat properties that may affect the biomechanics of a batter's swing. One aspect which will not be addressed is the material properties of bats. While this may be an intriguing and controversial topic, particularly regarding the discussion of metal versus wood bats, it is beyond the scope of this project because professional batters only use wood bats.

Many of the underlying physical principles regarding batting, pitching, fielding, and running in baseball are detailed in a famous book entitled The Physics of Baseball (Adair, 2002). With respect to the current research, the book describes a general biomechanical model of the baseball swing, the bat-ball collision, conditional changes that effect batted ball flight, and the effects of bat properties on the swing and ball flight. Adair said that for a well-hit ball, the collision between bat and ball takes place in a region known as the "sweet spot", an area very close to the bat's center of percussion (a vibrational node on the bat where no momentum is transferred to the handle and thus the batter does not feel a "sting" in his hands after contact). The terminology of sweet spot

and center of percussion are often (inappropriately) used interchangeably, since most reputable scientists distinguish the center of percussion and the point on the bat that maximizes ball exit velocity as two distinctly different points. The collision between bat and ball lasts for just 1 ms and more than 40,000 N of force is transmitted from the bat to the ball to redirect a 40 m/s pitch as a 50 m/s batted ball. This massive force compresses the ball to 50% of its diameter, though the wood bat is only compressed to 98% of its diameter. This collision is fairly inelastic, since much of the energy is lost due to frictional heat. This inelasticity is measured as the coefficient of restitution (COR), which is a ratio of the velocity before and after impact of two colliding objects. Another issue of contention is the batter's grip, which many believe to be vital to the success of the batter. By physical law, though, Adair contends that the batter's grip is completely irrelevant because the duration of BC is not long enough for a wave to propagate the length of the bat and shake loose the batter's grip on the bat. Ultimately, bat velocity and impact point are the two primary variables that determine ball flight (excluding bat mass). While there is a direct relationship between bat velocity and total ball flight distance, a number of extrinsic factors can also somewhat affect the ball's total flight distance. These include altitude, air pressure, wind, humidity, pitch speed, and bat properties. They can each alter the distance of a 120 m hit up to 3 m either way.

Adair went on to describe the effects of changing dimensions of the bat including length, diameter, and particularly bat mass on batting outcomes. Typically, longer bats are heavier than shorter bats. As for diameter, the bats of players in the early days through the 1960s or 1970s were closer to 70 mm whereas the current players have a diameter of about 65 mm, which reduces the bat mass, but also reduces the bat's contact

area. In the simplest theoretical model, for a given amount of total energy produced by the batter, the ball can be hit the furthest against a faster pitch with a heavier bat while a slower pitched ball would optimally be hit with a lighter (faster) bat. It is also suggested that the optimal bat mass is proportional to the batter's body mass. As Adair quickly pointed out, though, while these ideals may hold true in theory, they certainly do not hold true in practice because they assume that the batter is only trying to maximize ball flight distance and not necessarily frequency and/or quality of contact. In this case, batters often choose lighter bats to more skillfully guide the bat through the hitting zone, a choice that Adair pointed out may not diminish the ball flight distance that considerably. He estimated that a change from a 1.08 kg bat to a 0.91 kg bat would afford the batter about 13 ms more time to react to a pitch travelling 40 m/s.

While many of these theoretical considerations analyze perfectly struck balls, one must also realize that most balls are contacted imperfectly, and that analysis of those swings is much more practical and relevant to the study of the baseball swing. Assuming a ball hit solidly to centerfield for a base hit with a level swing, swinging the bat 50 mm below the ball's center will result in a ball fouled high and straight back over the catcher's head and out of play, swinging the bat 25 mm below the ball will be a routine flyout, but swinging the bat 19 mm below the ball's center will maximize the ball's flight distance, partially by creating backspin to further propel the ball. Conversely, it is suggested that an effective ground ball hit should not make contact more than 10 mm above the ball's center. On an 864 mm bat, the sweet spot (node of the fundamental vibration  $\approx 170$  Hz) is approximately 178 mm from the barrel end of the bat. The sweet spot is located about 25 mm from the point on the bat that maximizes ball flight distance,

so most batters equate well-hit balls with this spot, though they are actually two distinctly different points along the bat's axis. Still, the parabolic shape of a graph illustrating the relationship between the ball's flight distance and the distance between the bat's sweet spot and the BC point along the bat's axis demonstrates the exponentially bad effect a mishit can have on a batting outcome.

Quite a few scientists in various fields of research have also reported on bat mass properties and their effects on bat performance. Sherwood, Mustone, and Fallon (2000), representing the facility currently responsible for testing Major League Baseball (MLB) equipment, presented its method for independently testing the ball and bat, and then using a finite element model to study the bat-ball collision. Their model concluded a maximum BEV of 40 to 42 m/s for wood bats. Nathan (2003) laid out a few models for testing bat efficacy, ultimately determining that collision efficiency, or the closely related variable of Ball Exit Speed Ratio (BESR), the metric on which high school and colleges currently rely for certification of bats for performance and safety, are the most effective in determining bat performance. Nicholls, Miller & Elliot (2006), when testing maximum ball exit velocity (BEV) of bats, however, saw that wood bats could produce a BEV of 51 m/s, exceeding the regulatory threshold of 43 m/s that governed bat production. They determined that this excess was due to a limitation in the certification process that did not include the bat's linear velocity as well as its angular velocity when calculating the threshold. Smith (2001) also commented that bat testing must be conducted at pitch speeds and bat swing speeds closer to actual game conditions, since many researchers conduct tests performed at relatively low speeds. Penrose & Hose (1999) used finite element modeling to show that flexural and vibrational properties should also be

important considerations along with center of mass and moment of inertia when shaping and weighting the bat during its design phase. Fleisig et al. (2002) and Bahill (2004) both concluded that the bat's moment of inertia is crucial both in regulating bats for safety and performance as well as for individual bat selection for maximum performance.

Other researchers have focused more on the mechanics of the baseball swing as they relate to the bat more than the batter. Sawicki, Hubbard, and Stronge (2003) furthered Adair's assumptions on optimizing swing parameters to maximize ball flight distance. Increased pitch speed and bat speed were of course listed as two essential components for a maximum distance hit. They claimed the batter should swing with an upward bat trajectory of about  $9^\circ$  and contact the ball 27 mm below its center line for maximum distance. They further asserted that an optimally hit curveball would travel further than an optimally hit fastball because the spin direction of the curve would help create additional backspin to propel the ball. Cross (2008) measured the forces and torques acting on the bat to develop a bat swing model, citing a small positive couple followed by a large negative couple. All of these studies have aimed at measuring the true effect of varying bat properties on BEV, though they recognize that the batter's physiological contributions to the swing override most bat contributions to batting.

## CHAPTER 3

### METHODS

The baseball swing is a complex movement that requires a unique combination of explosive power and hand-eye coordination. Good swing mechanics are essential for successful hitting. Coaches have proffered numerous theories on what good swing mechanics are, but little scientific research exists to support any theory. The purposes of this study were to define proper swing mechanics for fastballs down the middle and then compare swings at pitches thrown to various locations and at different speeds with a range of batting outcomes.

#### 3.1 Participants

Healthy professional baseball players ( $n=43$ ) were recruited from the Southern League, a class AA league. All players were position players. After obtaining internal review board (IRB) approval from St. Vincent's Hospital in Birmingham, AL, all available players were informed of the study and individually asked to participate. All participants were asked to read and sign an informed consent form detailing the study's procedures, as well as all risks and consequences of the study (See Appendix A). Ultimately, data for 33 of the players were available. These players were  $25 \pm 2$  years old, with a height of  $184 \pm 6$  cm and a mass of  $92 \pm 9$  kg.

#### 3.2 Instruments

All data collection took place at the American Sports Medicine Institute's biomechanics research laboratory. This facility contained a protective batting cage net

with approximate dimensions 20m long x 5m wide x 5m high. At one end were eight Eagle motion capture cameras (Motion Analysis Corp., Santa Rosa, CA) and 2 force platforms (Advanced Medical Technology Inc., Watertown, MA) for collecting biomechanical data. Four cameras each were mounted on two opposing walls in a ring-like pattern to capture reflective markers from eight distinct angles. A picture taken during data collection, visualizing the orientation of the lab, the location of the batter, and the batting practice pitcher, is shown in Figure 1. The force platforms (approximately 46 cm x 51 cm) were flush with the ground and were oriented so that a batter, when facing the pitcher, could place his trail foot on one platform and his lead foot on the other. The batters swung self-selected wood baseball bats during testing. The pitcher throwing to the hitters was protected by an “L-screen”. Standard white baseballs were entirely covered in reflective tape so the cameras could track their location in space.



Figure 1. American Sports Medicine Institute biomechanics lab setup.

### 3.3 Procedures

The study was conducted during the middle of the baseball season so that players were in baseball-playing shape and regularly practicing their batting skills. Each participant reported to the biomechanics laboratory for testing at a previously assigned time. After reading and signing the informed consent form, hitters were asked to change into snug fitting shorts, socks, and non-reflective indoor turf shoes. A hat was provided. Before data were recorded, each participant was given time to familiarize himself with the laboratory setting. The hitter was also allowed to perform any calisthenics or warm-up drills to prepare him for the testing procedure.

Reflective markers were placed on the seventh cervical vertebra and right scapula and bilaterally on the clavicles (collarbones), acromion processes (shoulders), the medial and lateral epicondyles (elbows), the forearms, the radial and ulnar styloid processes (wrists), the third metacarpals (hands), anterior and posterior superior iliac spines (pelvis), the greater trochanters (thighs), the lateral and medial femoral condyles (knees), the lateral and medial malleoli (ankles), and on the shoes directly behind the calcanei (heels) and over the third metatarsals (toes). For batters who wore batting gloves, markers were placed on the gloves directly over the wrist and hand landmarks. The batting gloves were worn tight on the hands so there was little concern for additional artifact created by movement of the markers on the gloves. The baseball hat given to the players to wear for testing was adorned with four markers on the front, top, rear, and side. Finally, three markers were placed on the bat cap, knob, and just below the bat's "trademark". The bat cap "marker" was a 4 x 4 cm piece of reflective tape secured to the cap. Two pictures, shown as Figures 2a and 2b, display anterior and posterior views of



the marker placement on the batter and bat. After the markers were placed on the participant, any additional time needed to adjust to performing while wearing them was given. Any warm-up swings to prepare for the batting session were also allowed.



Figure 2a and 2b. (a) Anterior view and (b) posterior view of marker placement.

The hitter took his stance in the middle of the cameras' capture volume with one foot on each force plate. The positive X axis pointed from home plate towards the pitcher, the positive Z axis was vertical, and the positive Y axis was their cross-product,  $Z \times X$ . An experienced batting practice pitcher threw the reflective-markered baseballs to the hitter from a distance of approximately 13 m. The pitcher varied the pitches by speed and location. While the data analysis was designed to compare changes in hitting mechanics due to pitch speed and location separately, the protocols for testing these variations were combined into one protocol to more accurately simulate the

unpredictability of batting in game situations. Fastballs were thrown to one of five different locations within the strike zone (high and inside, high and outside, low and inside, low and outside, and “down the middle”), while the majority of changeups were thrown “down the middle”. Occasionally, changeups were thrown to different locations to prevent the hitter from recognizing any pattern in the pitching sequence. The overall ratio of fastballs to changeups was roughly four to one. This ratio is based on recommendations given by pitching coaches to pitchers (House, 2000).

For each pitch, the motion capture system tracked the three dimensional locations of the body, bat, and ball markers at a rate of 300 Hz and the force plates recorded the ground reaction forces also at a rate of 300 Hz. To monitor the data collection and ensure that enough of the proper types of trials were collected, a member of the research team noted the location (HIGH IN, HIGH OUT, LOW IN, LOW OUT, or MIDDLE) and speed (fastball or changeup) of the pitch and informed the pitcher. From the motion data, pitch speed (PS) was computed as  $25.0 \pm 0.6$  m/s for fastballs and  $21.3 \pm 0.6$  m/s for changeups. Each hitter took approximately 40 swings, depending on the number of useful trials collected. All useful trials were retained for analysis, though this inevitably created an unequal number of trials (i.e. unbalanced design) for each “trial type”. This issue is addressed further in Section 3.5 – Statistical Analysis.

### 3.4 Data processing

Kinematic and kinetic data were automatically synchronized and manually cropped from a few frames before the hitter’s initial movement until a few frames past follow-through. First, the raw XYZ positions of the markers were passed through a 12

Hz Butterworth filter within the motion analysis software to smooth out any artifacts created from digitizing errors or skin movement. The force plate data were left unfiltered to avoid oversmoothing and subsequent underestimation of peak GRF. Next, the data were processed through Sky scripts designed to work with the Skeleton Builder and KinTools application softwares (Motion Analysis Corporation, Santa Rosa, CA) which were programmed to calculate all of the kinematic, kinetic, and temporal variables analyzed in this study. These programming codes are located in Appendix C, one code for kinematics and one code for kinetics. The global ball location was tracked as its path approximately 5 m before and after contact with the bat. All swings with a quantifiable ball exit velocity (BEV) were also denoted as a successful result, while foul tips and misses were marked as failures. The kinematic position variables included in the current analyses were global rotation of the head, pelvis (including tilt, obliquity, and transverse rotation), and upper trunk; flexion, lateral flexion, and rotation of the upper trunk with respect to the pelvis; rotation of the shoulders with respect to the upper trunk (in polar coordinates and termed “elevation” and “azimuth”); flexion of the elbows; flexion of the knees; stride length and direction; global angle of the lead foot with respect to the X axis; global bat rotation (in polar coordinates and termed “elevation” and “azimuth”); and bat lag (similar definition to Welch et al. (1995)). All of these variables were measured in degrees, except for stride length (% of participant’s total height) and stride direction (centimeters). Diagrams of these variables are featured in Appendix B. A three-point central difference method was used to calculate global velocities for the pelvis, upper trunk, and bat azimuth and local velocities for the lead shoulder azimuth, trail elbow, and lead knee (all in degrees per second). The kinetic variables included ground reaction

forces (GRF) in the global X, Y, and Z planes ( $F_x$ ,  $F_y$ , and  $F_z$ ), and these were measured as a percentage of the participant's total body weight (%BW). All GRF values were generally positive except for lead foot GRF<sub>x</sub> and GRF<sub>y</sub>, which were negative to reflect the opposing direction of the force.

A few adjustments were made in the programming codes to make data interpretation easier. These customized programming codes were adapted to produce equivalent values for left- and right-handed batters according to the global orientation of the testing facility described earlier. Several definitions of variables were oriented to mimic the batter's initial stance. The batter looking at the pitcher was approximately 0° of head rotation while the batter looking at home plate was approximately 90° of head rotation. The pelvis pointing towards home plate was approximately 0° of rotation while the pelvis pointing towards the pitcher was approximately 90° of rotation. Total extension of the elbows and knees was towards 0° while total flexion was towards 180°. An open stride direction was negative while a closed stride direction was positive. The initial bat azimuth was equivalent to -180° while the bat azimuth near contact was equivalent to 0°. The rest of the orientations are described as needed throughout the relevant results sub-sections.

A number of programs were written in MATLAB (MathWorks, Natick, MA) to help process the data outputted from the Motion Analysis software and re-arrange the data into spreadsheets in preparation for statistical analysis. The three main programs can be seen in Appendix D. The primary goals of the first program ("complete\_baseball.m") were to combine the kinematic and GRF data of a given trial, extract data from key events, and determine maxima and minima of selected kinematic and GRF data. The

goal of the second program (“graph\_constructor.m”) was to group together and average trials of the same pitch location, pitch type, and/or batting outcome for a given participant. The goal of the third program (“graph\_compiler.m”) was to compile the averaged data by trial type for plotting graphs. Eventually, five key events were identified: lead foot off (the instant when the front foot GRFz fell below 10% BW), lead foot down (the instant when the front foot GRFz rose back above 10% BW), weight shift commitment (the instant when the front foot GRFz passed beyond 50% BW), maximum GRFz (the instant of maximum front foot GRFz), and bat-ball contact (BC) (the instant when the incoming pitch deviated from its initial trajectory). The frame of BC of misses had to be estimated based the position of the ball at BC of successful swings against the same pitch type/location. These events demarcated six operationally defined phases of the swing: stance, stride, coiling, swing initiation, swing acceleration, and follow-through.

### 3.5 Statistical analysis

A number of statistical techniques were employed to analyze the data. For the biomechanical description of the swing, only successful swings against fastballs down the middle were considered. Fastballs are the most common pitch thrown in games and pitches down the middle are the most neutral and usually the most desirable for batters. All kinematic and GRF variables were separately plotted against time (relative to BC) with each participant’s averaged trials. Those plots were then averaged together to create a single curve (including plus or minus one standard deviation) to represent the “typical” professional batter. The plots were carefully reviewed and then described collectively phase by phase from stance through follow-through. To remain concise while still

conveying as much relevant data as possible, the stance phase began at  $-1000$  ms and the follow-through phase terminated at  $+200$  ms. Before  $-1000$  ms the batter was rather still, and around  $+200$  ms, in the context of a real game, the batter was assumed to have begun his transition from batter to runner.

To compare successful swings against fastballs thrown to one of five locations (HIGH IN, HIGH OUT, LOW IN, LOW OUT, or MIDDLE), two different techniques were utilized. First, to simply compare the values among the pitch locations, general linear models (GLM) with repeated measures were constructed for each dependent variable. These models provided an advantage over ANOVA since they allowed for the incorporation of an unequal number of trials per person by adjusting the sums of squares for each of the terms in the model. Two terms were entered into each model: the pitch location (LOC) was a within-subjects factor with fixed effect; and a “subject” variable ( $\mu$ ) was a factor with random effect used to account for between- and within-subjects variability as well as the fact that the batters were a sample from a larger population (i.e. all professional hitters). The parameters used as dependent variables in this procedure were selected kinematic angles at the instant of BC (lead knee flexion, pelvis rotation, upper trunk rotation with respect to the pelvis, lead shoulder elevation and azimuth, trail elbow flexion, bat lag, bat elevation and azimuth, and head rotation), selected magnitude and timing of peak kinematic angular velocities (lead knee extension, pelvis rotation, upper trunk rotation, lead shoulder azimuth, lead elbow extension, and bat azimuth), and magnitude and timing of all peak GRF in the X, Y, and Z directions. When appropriate, a Tukey post-hoc comparison test with  $\alpha=.05$  was administered to determine the exact differences among the five pitch locations to aid in thoroughly describing the effect of

LOC on the biomechanical parameters. Grouping some of the pitch locations together (e.g. HIGH IN + LOW IN = inside) to generalize some of the findings was also considered when interpreting the outcomes of the statistical tests.

The second statistical technique used to compare swing biomechanics against fastballs thrown to different pitch locations involved the relationship of the biomechanical parameters to BEV. For each parameter, a separate GLM was constructed such that BEV was on the left side of the equation while ten parameters were entered on the right side. Initially, those on the right side were the four main terms (the biomechanical parameter,  $\mu$ , LOC, and PS) and all six possible two-way interactions between the main terms. Using backwards elimination, the least significant term was removed from each model until only statistically significant terms (i.e.  $p < .05$ ) remained. If the biomechanical parameter was ultimately retained in the model, the coefficients derived from each GLM were used to create an equation relating BEV to the significant terms. This equation was then reduced to produce “average” plots of an estimated BEV over the range of measured values of the biomechanical parameter. Since  $\mu$  is inherently zero when looking at the entire group, terms including this subject variable were dropped from the equation when forming the plots and the mean PS (25.0 m/s) was plugged in when the PS term was present in the equation. A graph containing the plots of the data for all pitch locations was compiled for each variable. A brief analytical summary based on all available results addressed any relationships between BEV and the given biomechanical parameter, particularly those that would be of practical significance.

The final analysis compared swings against fastballs and changeups with successful and failed results. The analysis was ultimately reduced to three operationally

defined “trial types”: successful results against fastballs thrown down the middle (Fast–Success), successful results against changeups (Change–Success), and failed results against changeups (Change–Fail). Failed results against fastballs thrown down the middle occurred very rarely, and the reason for their occurrence was believed to be beyond the scope of this analysis. The technique employed for this analysis was nearly identical to the first technique used for the pitch location comparison. All of the same dependent variables were again used in this pitch type comparison, with a GLM again constructed for each dependent variable. Two parameters were again entered into the GLM to model these dependent variables: trial type (within-subjects factor with fixed effect) and the subject variable (factor with random effect used to account for within- and between-subjects variability and aid in external validity). Whenever trial type was a significant term in the GLM, a Tukey post-hoc comparison test with  $\alpha=.05$  was administered to determine the exact differences among the three trial types.



## CHAPTER 4

### RESULTS

#### 4.1 Biomechanical description of the swing

This section used average graphs of all of the measured biomechanical variables over time to represent the “typical” professional batter. The majority of these graphs are featured separately in Appendix E. The following section presents a phase by phase summary of these graphs. All magnitudes correspond to the value as seen in the graph of that variable (i.e. the thick curve representing the average). All time values are with respect to the instant of BC.

##### 4.1.1. Stance

The lead foot bore less of the body’s weight throughout this initial phase, with GRFx dropping from 12% BW to 5% BW and GRFz dropping from 37% BW to 17% BW (a slightly misleading value due to the averaging effect). Contrastingly, the trail foot accepted more of the body’s weight with its GRFx rising from 11% BW to 18% BW and its GRFz rising from 57% BW to 86% BW. Both knees also flexed, with the lead knee bending from 36° to 48° and the trail knee bending from 51° to its maximum value of 56°. During these pre-stride movements, the pelvis drifted back in the negative X direction approximately 6 cm. The average time of the lead foot off event was –621 ms.

##### 4.1.2 Stride

Throughout the stride, the trail foot pushed with a constant GRFx of 21% BW while the GRFz gradually rose from 86% BW to a peak value of 92% BW around –500

ms and then began to fall back down to 83% BW. The average stride length was 42% of the subjects' height, and the lead foot went from an even stance (lead and trail foot even on Y axis) to a position of 11 cm closed while the foot angle (with respect to the X axis) opened from 69° to 63°. As the leg rose up off the ground, the lead knee bent to a maximum flexion angle of 52° around -483 ms. As the batter strode out, the trail knee extended from 56° to 50° and the pelvis moved forward 7 cm in the positive X direction (towards the pitcher). The pelvis's orientation also changed slightly, posteriorly tilting from -15° to -20° and reverse rotating in the transverse plane from -10° to -18° along with the upper trunk (-9° to -16°). The rest of the upper body initiated some movement, too, with the reverse rotation of both shoulders (lead azimuth: -16° to -25°; trail azimuth: -65° to -81°), and the extension of the lead elbow from 89° to 78°. By the end of the stride phase, the bat had elevated to a maximum of 44° and had continued to be wrapped behind the batter's head, rotating from an azimuth of -198° to -226°. The stride phase terminated when the lead foot returned to the ground (i.e. GRFz > 10% BW) at approximately -340 ms.

#### 4.1.3. Coiling

For all participants, while the lead foot GRFz may have oscillated above and below 10% BW following the "lead foot down" event, batters never fell below the 50% BW threshold that terminated the coiling phase once past that value until after the event of maximum GRFz. As the lead foot GRFz increased, the trail foot GRFz decreased from 83% BW to 47% BW during the phase. The batter's weight began to shift forward; the lead foot GRFx and GRFy braking forces increased from 2% BW to 11% BW and 1%

to 23% BW), respectively, along with the trail GRFy propulsive force (0% BW to 20% BW), while the trail foot GRFx propulsive force declined from 21% BW to 11% BW. The trail knee straightened to its maximum extended position of 44° around -220 ms, while the pelvis moved forward 11 cm more towards the pitcher in the positive X direction and the lead foot continued to open (63° to 56°). The pelvis also achieved a maximum posterior pelvic tilt of -26° at the very end of the coiling phase and a maximum counter-rotated position of -21° around -250 ms. By the end of the phase, the pelvis began to rotate forward to -14°, accelerating to an angular velocity of 239°/s. The upper trunk lagged behind the pelvis, not achieving its maximum counter-rotated global position of -22° until -186 ms.

The upper body became more active during coiling. With respect to the pelvis, the upper trunk counter-rotated, going from +2° to -9°. Following this coiling pattern, both shoulders also counter-rotated, with the lead shoulder reaching a minimum azimuth of -30° at the very end of the phase while the trail shoulder reached a minimum azimuth of -84° around -200 ms. Throughout the phase, the lead shoulder elevated from 81° to 88° while the trail shoulder depressed from 80° to 71°. The lead elbow extended further from 78° to 72° and the bat reached its minimum azimuth of -232° around -243 ms. The head also began to rotate, moving from 28° to 34°. The coiling phase ended with the lead foot accepting 50% BW in GRFz at approximately -170 ms.

#### 4.1.4. Swing Initiation

This phase was marked by major movements in the lower body and moderate movements in the upper body. The lead foot GRFx increased rapidly from 11% BW to

its maximum value of 50% BW while GRF<sub>y</sub> peaked at 28% BW around -123 ms. By definition, the lead foot GRF<sub>z</sub> rose quickly during the swing initiation phase from 50% BW to its maximum value of 130% BW. The trail foot GRF<sub>y</sub> also peaked during this phase (24% BW) around -127 ms, while the trail foot GRF<sub>z</sub> waned from 47% BW to 34% BW. The lead knee began to extend, going from 48° to 40°, while the trail knee flexed from 47° to 54°. The pelvis continued moving forward a further 5 cm in the positive X direction and also began anteriorly tilting from -26° to -19°, obliquely tilting from 1° to 14° (trail hip towards the ground), and rotating rapidly from -13° to 20°. The pelvis rotated with great acceleration, rising up close to its maximum with a speed of 558°/s by the end of the phase.

The upper trunk flexed forward slightly (8° to 13°) throughout the phase and began to rotate forward like the pelvis from -22° to 2°, accelerating to an angular velocity of 610°/s. However, the upper trunk continued to lag behind the pelvis, reaching a maximum separation (i.e. upper trunk rotation angle with respect to pelvis) of -18° at -103 ms. The lead upper arm began to move down and forward, as the shoulder reached a peak elevation of 89° at -146 ms before depressing to 80° by the end of the phase, while the azimuth increased from its minimum value of -30° to -23°, an acceleration resulting in a velocity of 171°/s. The lead elbow extended only slightly (72° to 68°). The trail upper arm dropped and moved forward substantially during this phase (shoulder elevation: 71° to 49°; shoulder azimuth: -78° to -42°), while the trail elbow remained quite flexed throughout (128° to 126°). As expected by the name of the phase, the bat finally began to rotate forward, uncoiling from an azimuth of -225° to -175°. This involved a large acceleration, with a rise in velocity from 236°/s to 1247°/s. The lag

between the body and bat increased, however, from  $121^\circ$  to  $131^\circ$ . The head peered down from  $-12^\circ$  to  $-18^\circ$ , laterally flexed toward the trail shoulder from  $-9^\circ$  to  $-15^\circ$ , and continued rotating away from the pitcher ( $34^\circ$  to  $41^\circ$ ). The swing initiation phase ended with maximum lead foot GRFz at  $-93$  ms.

#### 4.1.5. Swing Acceleration

The lower body was still very active during the beginning of the swing acceleration phases, while very rapid movements in the upper body occurred just before BC at the end of phase. All of the GRF dissipated during this phase, both in the lead foot (Fx:  $-50\%$  BW to  $-13\%$  BW; Fy:  $24\%$  BW to  $-5\%$  BW; Fz:  $130\%$  BW to  $64\%$  BW) and the trail foot (Fx:  $10\%$  BW to  $-3\%$  BW; Fy:  $20\%$  BW to  $1\%$  BW; Fz:  $34\%$  BW to  $15\%$  BW). The lead knee rapidly extended from  $40^\circ$  to  $18^\circ$  throughout the phase, reaching a peak extension velocity of  $263^\circ/\text{s}$  at  $-40$  ms. The pelvis also rose in the Z direction 5 cm, while anteriorly tilting from  $-20^\circ$  to  $8^\circ$ , obliquely tilting from  $14^\circ$  to  $27^\circ$ , and rotating nearly  $60^\circ$ , approximately facing the pitcher ( $19^\circ$  to  $77^\circ$ ). The batter's maximum pelvis rotation velocity was achieved early in the swing acceleration phase, rising to a peak of  $581^\circ/\text{s}$  by  $-70$  ms, later slowing to  $287^\circ/\text{s}$  by BC. As the batter rotated his entire body during swing acceleration, the lag between the pelvis and the upper trunk decreased from  $-18^\circ$  to  $-2^\circ$  (global upper trunk angle:  $2^\circ$  to  $75^\circ$ ), and this was facilitated by a maximum upper trunk rotation velocity of  $766^\circ/\text{s}$  achieved at  $-57$  ms. This value gradually fell to  $430^\circ/\text{s}$  by BC. The upper trunk also laterally flexed slightly toward the trail hip ( $9^\circ$  to  $4^\circ$ ).

The lead upper arm continued as it did in the swing initiation phase by dropping down and forward (shoulder elevation:  $81^{\circ}$  to  $70^{\circ}$ ; shoulder azimuth  $-24^{\circ}$  to  $-1^{\circ}$ ), reaching a local peak shoulder azimuth velocity of  $342^{\circ}/s$  at  $-43$  ms. The lead elbow also extended from  $68^{\circ}$  to  $56^{\circ}$ . The trail upper arm followed a similar path, dipping down to a minimum just before BC (shoulder elevation:  $35^{\circ}$  at  $-23$  ms) and continued to rotate forward ( $-42^{\circ}$  to  $-9^{\circ}$ ), while the trail elbow extended rapidly from  $126^{\circ}$  to  $81^{\circ}$ , accelerating first to a local maximum peak velocity of  $476^{\circ}/s$  at  $-47$  ms (trail elbow angle:  $109^{\circ}$  at  $-47$  ms), briefly decelerating, and then accelerating again to  $752^{\circ}/s$  by BC. The bat's elevation dropped below parallel, falling from  $39^{\circ}$  to  $-30^{\circ}$  at BC. The lag between the body and bat increased to a maximum of  $133^{\circ}$  at  $-80$  ms, but then the bat began to catch up to the body as the lag decreased to  $66^{\circ}$  by BC. In doing so, the bat moved through an arc of nearly  $170^{\circ}$  during this phase ( $-175^{\circ}$  to  $-7^{\circ}$ ), accelerating at a tremendous rate to the maximum bat azimuth velocity ( $2435^{\circ}/s$ ) at  $-10$  ms. The head continued to laterally flex toward the trail shoulder ( $-15^{\circ}$  to  $-31^{\circ}$ ) throughout the swing acceleration phase and rotated from  $41^{\circ}$  to a maximum of  $49^{\circ}$  at  $-33$  ms before beginning to rotate back towards the pitcher ( $47^{\circ}$  at BC).

#### 4.1.6. Follow-Through

The final phase of the swing was highlighted by some actions that occurred just after BC as well as some decelerating movements. Many of the variables reached a minimum or maximum value at some point during the phase and then slowly began to return in the opposite direction while the body stabilized. The lead foot GRFx and GRFz continued to dissipate, reaching local minimums around  $+35$  ms (Fx: 5% BW; Fz: 51%

BW) before experiencing an increase to a local maximum around +110 ms (Fx: 23% BW; Fz: 68% BW). Changes in trail foot GRFx and GRFy were minimal, but the trail foot GRFz gradually increased from 13% BW to 41% BW by the end of the phase. The lead foot continued to open up and point towards the pitcher, moving from 49° at BC to 36° around +60 ms, holding steady at that value until around +150 ms before opening further through the end of the phase. The lead knee moved from 18° into its most extended position (11° at +73 ms) before beginning to stabilize to a more flexed position. The pelvis continued to move in all three planes: anteriorly tilting from 8° to a maximum of 16° by +60 ms, obliquely tilting to a maximum of 30° by +93 ms, and rotating from 77° to a local maximum of 85° at +43, counter-rotating a few degrees and then rotating forward to 95° by the end of the phase.

The upper trunk reached its maximum forward flexion (16°) at +30 ms and then extended to a more erect 7° by the end of the phase while the segment rotated forward throughout the phase (-2° to 40° with respect to pelvis; 75° to 135° globally). The lead upper arm continued its down and forward path, as the shoulder elevation angle lowered from 70° at BC to a minimum of 42° at +140 ms and the azimuth, except for a brief retreat of a few degrees following contact, increased from -3° at +20 ms to 35° by the end of the phase. The lead elbow reached its maximum extension (42°) at +43 ms and then flexed back up to a local maximum of 73° by the end of follow-through. The trail upper arm moved forward as well, though unlike the lead arm, it rose during follow-through. The trail shoulder elevated from 37° to 77° while the azimuth increased from -9° to 27°. The trail elbow achieved its maximum extension velocity just after BC (868°/s at +17 ms), reached a minimum angle of 37° at +83 ms, and then gradually flexed

back to  $50^\circ$  by the end of the follow-through phase. The bat followed through by gradually rising back up from  $-30^\circ$  to  $28^\circ$  at +150 ms and continuously rotating forward (bat azimuth:  $-7^\circ$  to  $239^\circ$ ), decelerating from an azimuth velocity of  $2233^\circ/\text{s}$  to  $827^\circ/\text{s}$ . This quickness in the bat rotation temporarily led to the decrease in the lag between the bat and body, resulting in a minimum bat lag value of  $26^\circ$  at +67 ms that then increased to  $68^\circ$  by the end of the phase. The batter's head straightened and began to move back toward the field; after tilting to its furthest point towards the trail shoulder ( $-32^\circ$  at +30 ms) the head moved back more upright to  $-11^\circ$ , all the while rotating from  $47^\circ$  to  $11^\circ$ .

#### 4.2 Analysis of swing biomechanics with changes in pitch location

This analysis employed two separate techniques to measure how swing mechanics were modulated when fastballs were thrown to one of five locations (HIGH IN, HIGH OUT, LOW IN, LOW OUT, MIDDLE). The first technique compared swings against pitches to the five location on 34 biomechanical parameters. The second technique used linear regression to identify relationships between those biomechanical parameters and ball exit velocity (BEV).

##### 4.2.1 Comparison of swings by pitch location

In this section, a table is presented for the weighted mean and standard deviations of the raw data for each of the five subgroups of variables. Each table also denotes any significant post-hoc test results. The tables are followed by a summary of these findings.



Table 1. Mean  $\pm$  SD of kinematic angles at BC among the pitch locations (in degrees)

Variable	HIGH IN	HIGH OUT	LOW IN	LOW OUT	MIDDLE
Lead Knee Flexion <sup>b, e-i</sup>	17 $\pm$ 4	17 $\pm$ 4	15 $\pm$ 5	18 $\pm$ 4	18 $\pm$ 4
Pelvis Rotation <sup>a-h, j</sup>	79 $\pm$ 5	69 $\pm$ 8	76 $\pm$ 7	61 $\pm$ 10	77 $\pm$ 6
Upper Trunk Rotation <sup>a-j</sup>	1 $\pm$ 3	0 $\pm$ 5	-5 $\pm$ 4	-8 $\pm$ 4	-2 $\pm$ 4
Lead Shoulder Elevation <sup>a-c, e-j</sup>	70 $\pm$ 4	78 $\pm$ 4	63 $\pm$ 4	72 $\pm$ 4	70 $\pm$ 4
Lead Shoulder Azimuth <sup>a-h, j</sup>	14 $\pm$ 8	-6 $\pm$ 7	0 $\pm$ 10	-15 $\pm$ 4	-1 $\pm$ 8
Trail Elbow Flexion <sup>a-d, f-j</sup>	89 $\pm$ 8	77 $\pm$ 9	77 $\pm$ 10	66 $\pm$ 8	81 $\pm$ 8
Bat Lag <sup>a-f, h-j</sup>	79 $\pm$ 12	63 $\pm$ 11	58 $\pm$ 10	51 $\pm$ 7	65 $\pm$ 10
Bat Elevation <sup>a-j</sup>	-24 $\pm$ 5	-21 $\pm$ 4	-39 $\pm$ 4	-33 $\pm$ 5	-30 $\pm$ 5
Bat Azimuth <sup>a-c, e, g-j</sup>	-7 $\pm$ 14	-16 $\pm$ 12	2 $\pm$ 13	-12 $\pm$ 10	-8 $\pm$ 12
Head Rotation <sup>a-d, f, h, j</sup>	38 $\pm$ 5	48 $\pm$ 7	48 $\pm$ 5	55 $\pm$ 4	47 $\pm$ 5

- a) Significant difference between HIGH IN and HIGH OUT ( $p < .05$ )  
b) Significant difference between HIGH IN and LOW IN ( $p < .05$ )  
c) Significant difference between HIGH IN and LOW OUT ( $p < .05$ )  
d) Significant difference between HIGH IN and MIDDLE ( $p < .05$ )  
e) Significant difference between HIGH OUT and LOW IN ( $p < .05$ )  
f) Significant difference between HIGH OUT and LOW OUT ( $p < .05$ )  
g) Significant difference between HIGH OUT and MIDDLE ( $p < .05$ )  
h) Significant difference between LOW IN and LOW OUT ( $p < .05$ )  
i) Significant difference between LOW IN and MIDDLE ( $p < .05$ )  
j) Significant difference between LOW OUT and MIDDLE ( $p < .05$ )

Table 2. Mean  $\pm$  SD of timing of peak kinematic velocities among the pitch locations (in milliseconds relative to BC)

Variable	HIGH IN	HIGH OUT	LOW IN	LOW OUT	MIDDLE
Lead Knee Extension <sup>a, c, g, i-j</sup>	-31 $\pm$ 19	-38 $\pm$ 23	-39 $\pm$ 29	-45 $\pm$ 21	-30 $\pm$ 25
Pelvis Rotation <sup>a-d, f, h, j</sup>	-64 $\pm$ 13	-75 $\pm$ 14	-73 $\pm$ 16	-82 $\pm$ 11	-72 $\pm$ 15
Upper Trunk Rotation <sup>c, e, g-h, j</sup>	-58 $\pm$ 13	-63 $\pm$ 13	-55 $\pm$ 15	-65 $\pm$ 13	-59 $\pm$ 15
Lead Shoulder Azimuth <sup>b-f, i-j</sup>	-41 $\pm$ 12	-43 $\pm$ 11	-48 $\pm$ 14	-49 $\pm$ 12	-44 $\pm$ 13
Trail Elbow Extension <sup>a-f, i-j</sup>	25 $\pm$ 20	17 $\pm$ 12	3 $\pm$ 21	7 $\pm$ 12	16 $\pm$ 18
Bat Azimuth <sup>a-b, e-i</sup>	-11 $\pm$ 4	-14 $\pm$ 4	-8 $\pm$ 4	-10 $\pm$ 4	-10 $\pm$ 4

- a) Significant difference between HIGH IN and HIGH OUT ( $p < .05$ )  
b) Significant difference between HIGH IN and LOW IN ( $p < .05$ )  
c) Significant difference between HIGH IN and LOW OUT ( $p < .05$ )  
d) Significant difference between HIGH IN and MIDDLE ( $p < .05$ )  
e) Significant difference between HIGH OUT and LOW IN ( $p < .05$ )  
f) Significant difference between HIGH OUT and LOW OUT ( $p < .05$ )  
g) Significant difference between HIGH OUT and MIDDLE ( $p < .05$ )  
h) Significant difference between LOW IN and LOW OUT ( $p < .05$ )  
i) Significant difference between LOW IN and MIDDLE ( $p < .05$ )  
j) Significant difference between LOW OUT and MIDDLE ( $p < .05$ )

Table 3. Mean  $\pm$  SD of magnitude of peak kinematic velocities among the pitch locations (in degrees per second)

Variable	HIGH IN	HIGH OUT	LOW IN	LOW OUT	MIDDLE
Lead Knee Extension <sup>a-c, e, g-j</sup>	308 $\pm$ 39	289 $\pm$ 43	344 $\pm$ 51	291 $\pm$ 47	313 $\pm$ 41
Pelvis Rotation <sup>a-j</sup>	645 $\pm$ 29	568 $\pm$ 51	587 $\pm$ 48	506 $\pm$ 49	601 $\pm$ 38
Upper Trunk Rotation <sup>a-j</sup>	837 $\pm$ 62	784 $\pm$ 80	760 $\pm$ 82	699 $\pm$ 87	813 $\pm$ 71
Lead Shoulder Azimuth <sup>a-j</sup>	489 $\pm$ 81	324 $\pm$ 81	398 $\pm$ 106	263 $\pm$ 57	373 $\pm$ 92
Trail Elbow Extension <sup>a, c-e, g-j</sup>	894 $\pm$ 181	1026 $\pm$ 146	881 $\pm$ 203	1074 $\pm$ 154	979 $\pm$ 169
Bat Azimuth <sup>a-c, e-j</sup>	2430 $\pm$ 203	2259 $\pm$ 126	2786 $\pm$ 186	2370 $\pm$ 181	2486 $\pm$ 152

- a) Significant difference between HIGH IN and HIGH OUT ( $p < .05$ )
- b) Significant difference between HIGH IN and LOW IN ( $p < .05$ )
- c) Significant difference between HIGH IN and LOW OUT ( $p < .05$ )
- d) Significant difference between HIGH IN and MIDDLE ( $p < .05$ )
- e) Significant difference between HIGH OUT and LOW IN ( $p < .05$ )
- f) Significant difference between HIGH OUT and LOW OUT ( $p < .05$ )
- g) Significant difference between HIGH OUT and MIDDLE ( $p < .05$ )
- h) Significant difference between LOW IN and LOW OUT ( $p < .05$ )
- i) Significant difference between LOW IN and MIDDLE ( $p < .05$ )
- j) Significant difference between LOW OUT and MIDDLE ( $p < .05$ )

Table 4. Mean  $\pm$  SD of timing of peak GRF among the pitch locations (in milliseconds relative to BC)

Variable	HIGH IN	HIGH OUT	LOW IN	LOW OUT	MIDDLE
Trail Foot GRF <sub>x</sub> <sup>b</sup>	-392 $\pm$ 66	-400 $\pm$ 83	-379 $\pm$ 77	-376 $\pm$ 97	-388 $\pm$ 81
Trail Foot GRF <sub>y</sub> <sup>b, e-f</sup>	-134 $\pm$ 12	-138 $\pm$ 19	-126 $\pm$ 14	-128 $\pm$ 19	-132 $\pm$ 15
Trail Foot GRF <sub>z</sub>	-517 $\pm$ 53	-518 $\pm$ 50	-510 $\pm$ 44	-495 $\pm$ 51	-491 $\pm$ 55
Lead Foot GRF <sub>x</sub> <sup>a, c, e, g-h, j</sup>	-87 $\pm$ 14	-101 $\pm$ 20	-87 $\pm$ 16	-98 $\pm$ 19	-90 $\pm$ 17
Lead Foot GRF <sub>y</sub>	-137 $\pm$ 13	-134 $\pm$ 16	-134 $\pm$ 13	-131 $\pm$ 20	-135 $\pm$ 16
Lead Foot GRF <sub>z</sub> <sup>a, c, g, j</sup>	-92 $\pm$ 18	-106 $\pm$ 24	-98 $\pm$ 22	-99 $\pm$ 22	-93 $\pm$ 19

- a) Significant difference between HIGH IN and HIGH OUT ( $p < .05$ )
- b) Significant difference between HIGH IN and LOW IN ( $p < .05$ )
- c) Significant difference between HIGH IN and LOW OUT ( $p < .05$ )
- d) Significant difference between HIGH IN and MIDDLE ( $p < .05$ )
- e) Significant difference between HIGH OUT and LOW IN ( $p < .05$ )
- f) Significant difference between HIGH OUT and LOW OUT ( $p < .05$ )
- g) Significant difference between HIGH OUT and MIDDLE ( $p < .05$ )
- h) Significant difference between LOW IN and LOW OUT ( $p < .05$ )
- i) Significant difference between LOW IN and MIDDLE ( $p < .05$ )
- j) Significant difference between LOW OUT and MIDDLE ( $p < .05$ )

Table 5. Mean  $\pm$  SD of magnitude of peak GRF among the pitch locations (in milliseconds relative to BC)

Variable	HIGH IN	HIGH OUT	LOW IN	LOW OUT	MIDDLE
Trail Foot GRFx	25 $\pm$ 2	25 $\pm$ 2	26 $\pm$ 2	25 $\pm$ 2	25 $\pm$ 2
Trail Foot GRFy <sup>a,b, e-i</sup>	27 $\pm$ 2	29 $\pm$ 3	24 $\pm$ 3	28 $\pm$ 3	28 $\pm$ 2
Trail Foot GRFz	97 $\pm$ 2	97 $\pm$ 3	96 $\pm$ 2	94 $\pm$ 2	93 $\pm$ 2
Lead Foot GRFx <sup>a, c, g-j</sup>	-54 $\pm$ 6	-53 $\pm$ 6	-55 $\pm$ 5	-52 $\pm$ 5	-56 $\pm$ 5
Lead Foot GRFy <sup>a, f-g</sup>	-36 $\pm$ 4	-34 $\pm$ 4	-35 $\pm$ 3	-36 $\pm$ 3	-36 $\pm$ 3
Lead Foot GRFz <sup>a, c, e, g-h, j</sup>	143 $\pm$ 13	138 $\pm$ 14	146 $\pm$ 14	138 $\pm$ 15	149 $\pm$ 12

- a) Significant difference between HIGH IN and HIGH OUT ( $p < .05$ )
- b) Significant difference between HIGH IN and LOW IN ( $p < .05$ )
- c) Significant difference between HIGH IN and LOW OUT ( $p < .05$ )
- d) Significant difference between HIGH IN and MIDDLE ( $p < .05$ )
- e) Significant difference between HIGH OUT and LOW IN ( $p < .05$ )
- f) Significant difference between HIGH OUT and LOW OUT ( $p < .05$ )
- g) Significant difference between HIGH OUT and MIDDLE ( $p < .05$ )
- h) Significant difference between LOW IN and LOW OUT ( $p < .05$ )
- i) Significant difference between LOW IN and MIDDLE ( $p < .05$ )
- j) Significant difference between LOW OUT and MIDDLE ( $p < .05$ )

Variables in this particular analysis can be classified based on the patterning of differences amongst pitch locations. Many of the GRF variables either had no statistically significant findings among the pitch locations or a few results that were, in all practicality, insignificant. Other variables, such as the lead knee flexion angle at BC and the instants of peak upper trunk rotation velocity and peak bat azimuth velocity, also had statistically significant differences among pitch locations that, in all practicality, were rather small. On the other hand, some variables showed a trend for relatively large differences between inside (HIGH IN or LOW IN) and outside (HIGH OUT or LOW OUT) pitches while others showed a trend for relatively large differences between high (HIGH IN or HIGH OUT) and low (LOW IN or LOW OUT) pitches. At BC, the pelvis and lead shoulder and azimuths were rotated more open/forward on inside pitches compared to outside pitches. Peak velocities of lead knee extension, pelvis rotation, lead shoulder azimuth, and bat azimuth were also all greater for inside pitches than outside

itches, but the trail elbow extension velocity was greater for outside pitches than inside pitches. The timing of peak lead foot GRFx occurred closer to BC for inside pitches than outside pitches, and the magnitude of the peak lead foot GRFz was greater on inside pitches compared to outside pitches. Looking at the effect of high versus low pitches, the upper trunk position with respect to the pelvis at BC, as well as the peak global upper trunk rotational velocity, were both greater for high pitches compared to low pitches. Also, the bat was elevated more for high pitches and less for low pitches. The instants of peak lead shoulder azimuth velocity and trail elbow extension velocity occurred earlier in the swing (relative to the time of BC) for low pitches compared to high pitches.

A few variables showed large differences between HIGH IN and LOW OUT without necessarily demonstrating the more generalized relationship of inside versus outside pitches or high versus low pitches as other variables did, while the remaining variables that had statistically significant findings of practical importance had slightly more complex patterns. The trail elbow flexion angle at BC was 23° more bent for HIGH IN than LOW OUT pitches. At BC, the bat lagged behind the body approximately 25° more for HIGH IN than LOW OUT pitches, but the values for the other three locations were in between the bat lag of HIGH IN and LOW OUT with much smaller differences among them. The head's position at BC was rotated in to track the ball approximately 17° more for LOW OUT than HIGH IN pitches, while the values for the other three locations were in between those values and had no statistically significant differences. The instant of peak pelvis rotation velocity also displayed this pattern, with the pelvis maximally rotating approximately 19 ms earlier (relative to the time of BC) for LOW OUT compared to HIGH IN, with no statistically significant differences among MIDDLE,

LOW IN, and HIGH OUT pitches, all with values in between those of HIGH IN and LOW OUT. The time of peak lead knee extension velocity was 15 ms earlier for LOW OUT than HIGH IN and effectively represented the largest significant difference, though there was no pattern among the values at the other pitch locations. The shoulder was elevated 15° more at BC for HIGH OUT than LOW IN, but swings against the LOW OUT, MIDDLE, and HIGH IN pitches had similar shoulder elevations that were all in between the values for HIGH OUT and LOW IN. Lastly, no recognizable pattern was seen in the time of peak lead foot GRFz, HIGH IN and MIDDLE occurring closer to BC and LOW IN, LOW OUT, and HIGH OUT occurring earlier.

#### 4.2.2 Relationships between biomechanical parameters and BEV

In this second section, each biomechanical parameter is systematically presented in the following manner: a scatterplot of the raw data displaying the parameter against BEV, an analysis of variance table showcasing the significant parameters associated with BEV, an equation derived from that GLM and all of its coefficients for the biomechanical parameter, subject ( $\mu$ ), pitch location (LOC), pitch speed (PS), and the relevant interaction terms among these parameters (when applicable), an interpretive description of the data based on all available data, and a subsequent plot of the subject-independent model estimates of the BEV over the measured range of the biomechanical parameter (when applicable). Apart from statistically significant findings, results that are of practical significance are also discussed. As a guide, any effect that led to a BEV difference of greater than  $\pm 2.00$  m/s was considered “practically significant”.

## 4.2.2.1 Lead knee flexion at BC

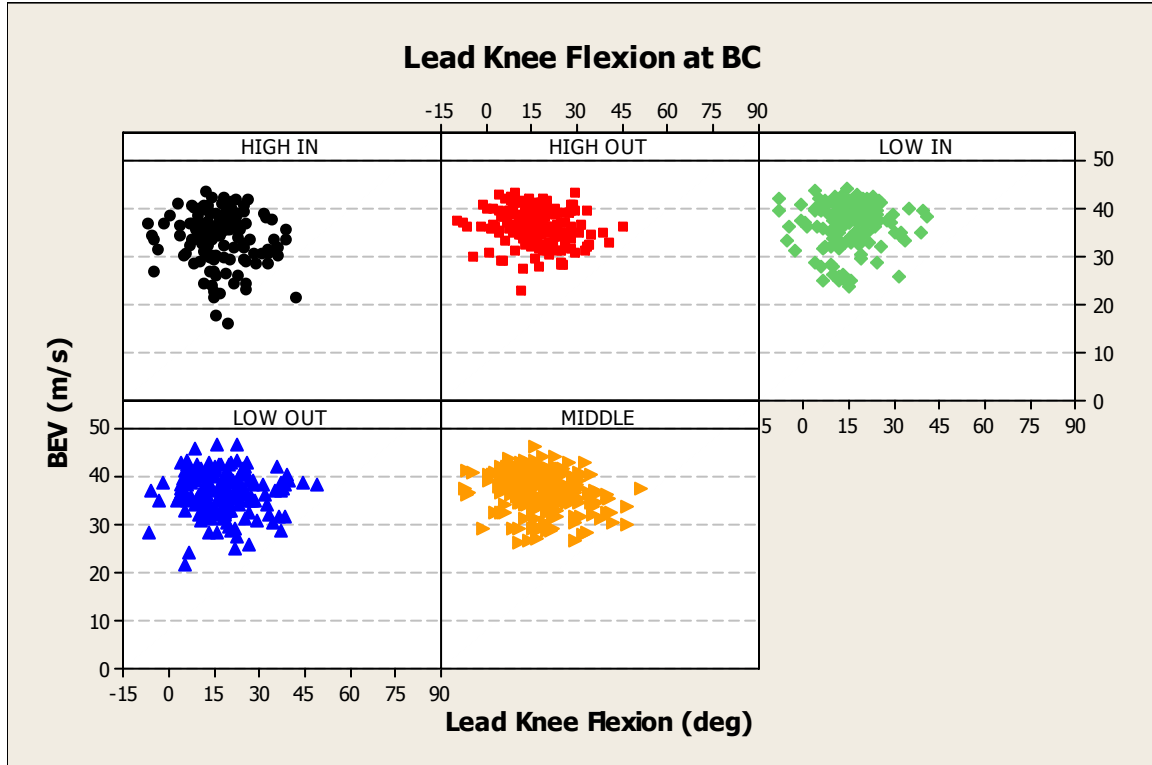

Figure 3. Lead knee flexion angle at BC across BEV (raw data)

Table 6. Analysis of variance for lead knee flexion angle at BC

Source	DF	Seq SS	Adj SS	Adj MS	F	P
Lead Knee Flexion	1	17.34	13.32	13.32	0.85	0.355
Subject	32	2846.10	794.68	24.83	1.59	0.021
Location	4	995.85	919.55	229.89	14.76	0.000
PS	1	161.70	160.14	160.14	10.28	0.001
Subject*PS	32	775.07	775.07	24.22	1.55	0.027
Error	801	12478.76	12478.76	15.58		
Total	871	17274.81				

As seen in Table 6, there was not a significant relationship between lead knee flexion at BC and BEV. Thus, no equation or graph of estimated BEV versus lead knee flexion at BC was developed.

## 4.2.2.2 Pelvis rotation at BC

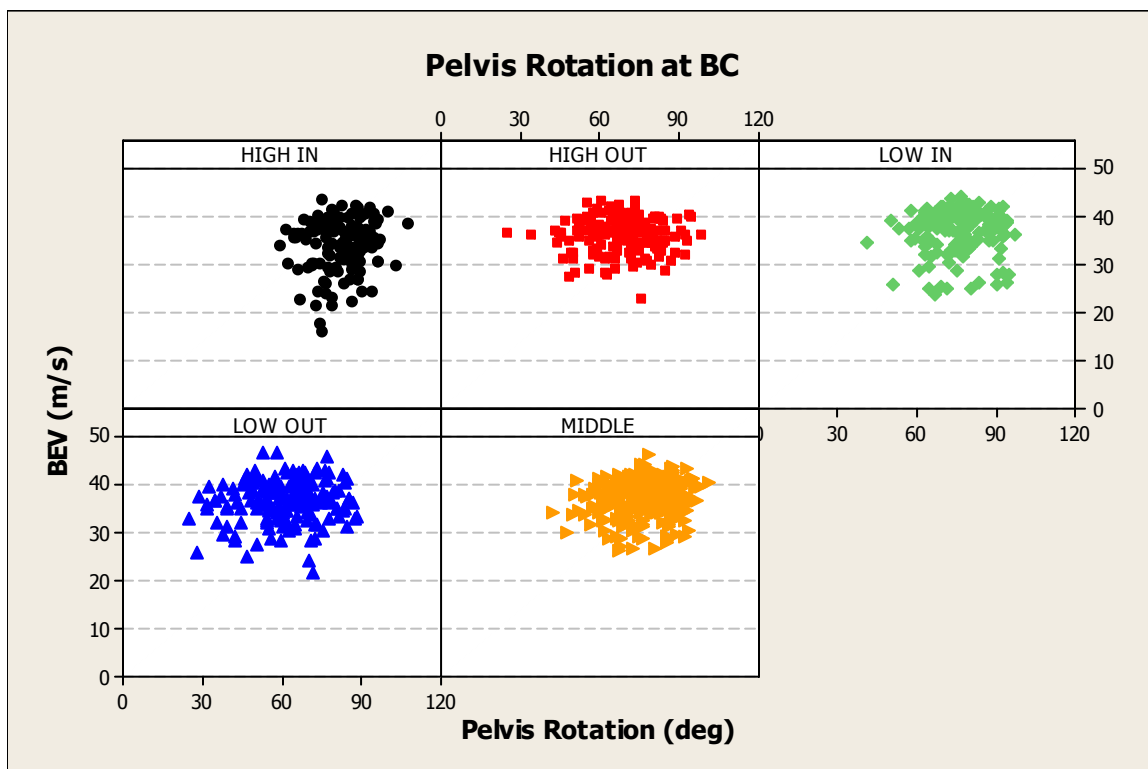

Figure 4. Pelvis rotation angle at BC across BEV (raw data)

Table 7. Analysis of variance for pelvis rotation angle at BC

Source	DF	Seq SS	Adj SS	Adj MS	F	P
Pelvis Rotation	1	16.64	91.46	91.46	6.10	0.014
Subject	32	2848.04	777.75	24.30	1.62	0.017
Location	4	1076.44	914.51	228.63	15.26	0.000
PS	1	180.38	130.40	130.40	8.70	0.003
Subject*Pelvis Rotation	32	830.69	837.32	26.17	1.75	0.007
Subject*PS	32	770.68	770.68	24.08	1.61	0.019
Error	772	11567.09	11567.09	14.98		
Total	874	17289.96				

$$\text{Eq. 1: } BEV = 9.75 + 0.05 * Pelvis\ Rotation_{BC} + A * \mu + B * LOC + +0.88 * PS + C * \mu * Pelvis\ Rotation_{BC} + D * \mu * PS$$

In Eq. 1, the coefficients were A: [-105.00 to 105.40], B: [HIGH IN = -2.26, HIGH OUT = 0.32, LOW IN = -0.03, LOW OUT = 0.81], C: [-0.25 TO 0.20], and D: [-4.03 to 4.06]. In practicality, increases in BEV were associated with increased (i.e.

more open) pelvis rotation angle at BC for all pitch locations. According to the model, the difference between the minimum and maximum measured values of pelvis rotation (24.79° to 107.48°, respectively) would lead to a BEV difference of +4.04 m/s. Figure 5 below visualizes the model-estimated BEV based on the range of measured values of pelvis rotation angle at BC.

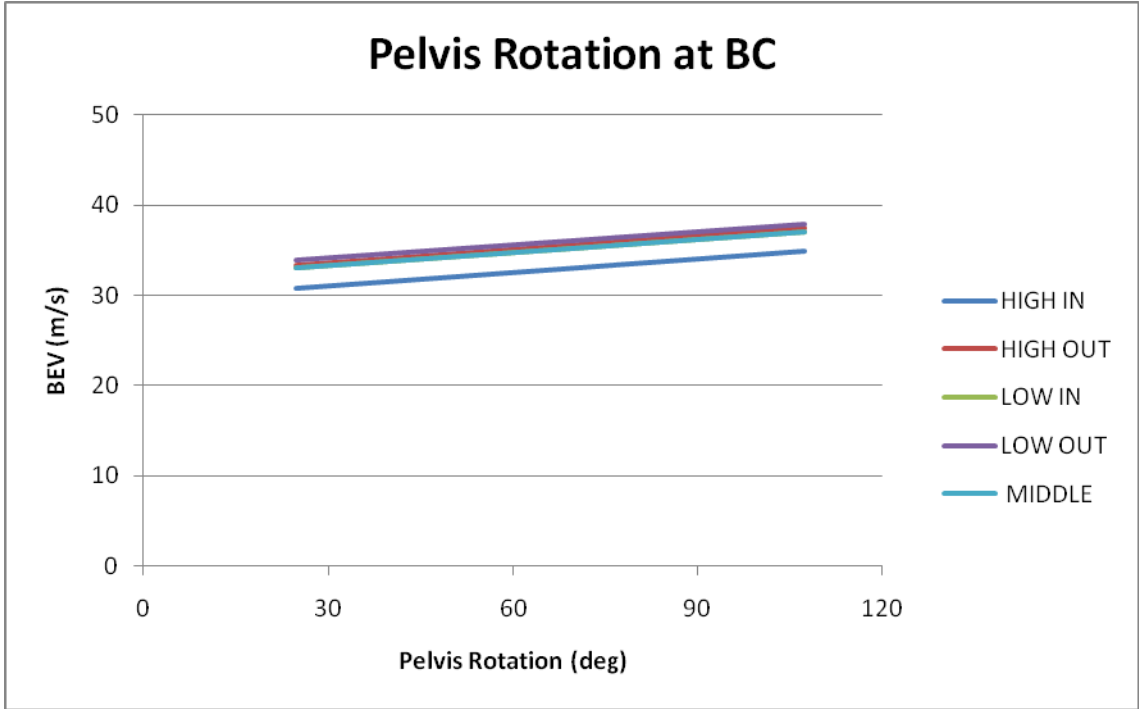

Figure 5. Model estimate of average BEV across values of pelvis rotation angle at BC.



## 4.2.2.3 Upper trunk rotation with respect to the pelvis at BC

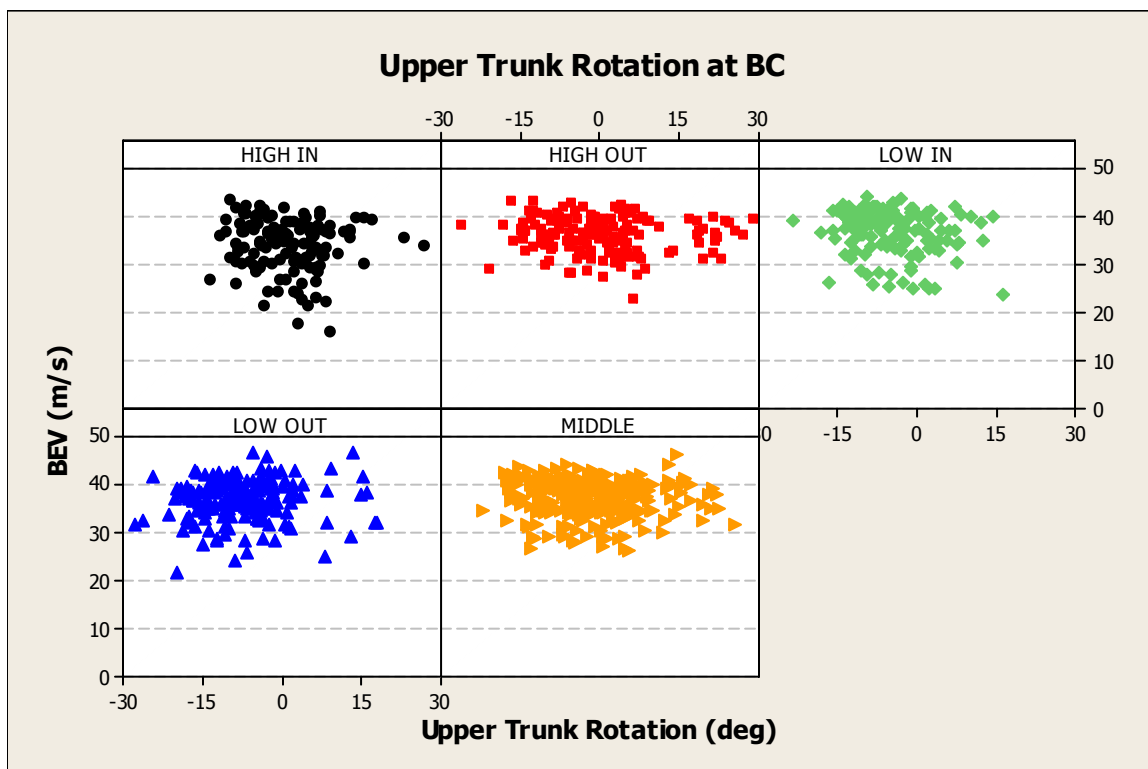

Figure 6. Upper trunk rotation angle at BC across BEV (raw data)

Table 8. Analysis of variance for upper trunk rotation angle at BC

Source	DF	Seq SS	Adj SS	Adj MS	F	P
Upper Trunk Rotation	1	152.01	33.29	33.29	2.23	0.136
Subject	32	2979.93	774.17	24.19	1.62	0.017
Location	4	774.74	698.88	174.72	11.71	0.000
PS	1	138.48	121.90	121.90	8.17	0.004
Subject*Upper Trunk Rotation	32	945.87	975.21	30.48	2.04	0.001
Subject*PS	32	777.09	777.09	24.28	1.63	0.016
Error	772	11521.24	11521.24	14.92		
Total	874	17289.37				

$$\text{Eq. 2: } BEV = 13.78 - 0.06 * \text{Upper Trunk Rotation}_{BC} + A * \mu + B * LOC + 0.86 * PS + C * \mu * \text{Upper Trunk Rotation}_{BC} + D * \mu * PS$$

In Eq. 2, the ranges for the coefficients were A: [-97.20 to 126.72], B: [HIGH IN = -1.63, HIGH OUT = 0.10, LOW IN = 0.03, LOW OUT = 0.11], C: [-0.57 to 0.53], and D: [-4.91 to 3.95]. In practicality, increases in BEV were associated with a

decreased (i.e. more closed) upper trunk rotation angle at BC for all pitch locations.

According to the model, the difference between the minimum and maximum measured values of upper trunk rotation ( $-27.55^\circ$  to  $29.28^\circ$ , respectively) would lead to a BEV difference of  $-3.23$  m/s. Figure 7 below visualizes the model-estimated BEV based on the range of measured values of upper trunk rotation angle with respect to pelvis at BC.

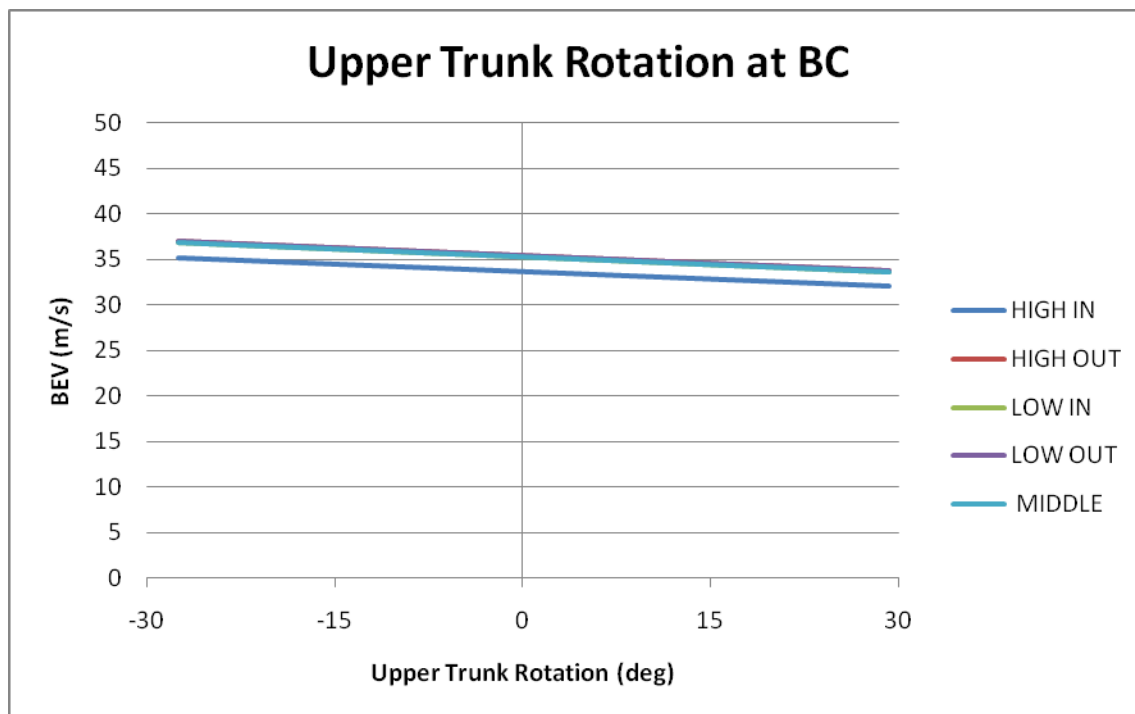

Figure 7. Model estimate of average BEV across values of upper trunk rotation angle with respect to pelvis at BC.

4.2.2.4 Lead shoulder elevation at BC

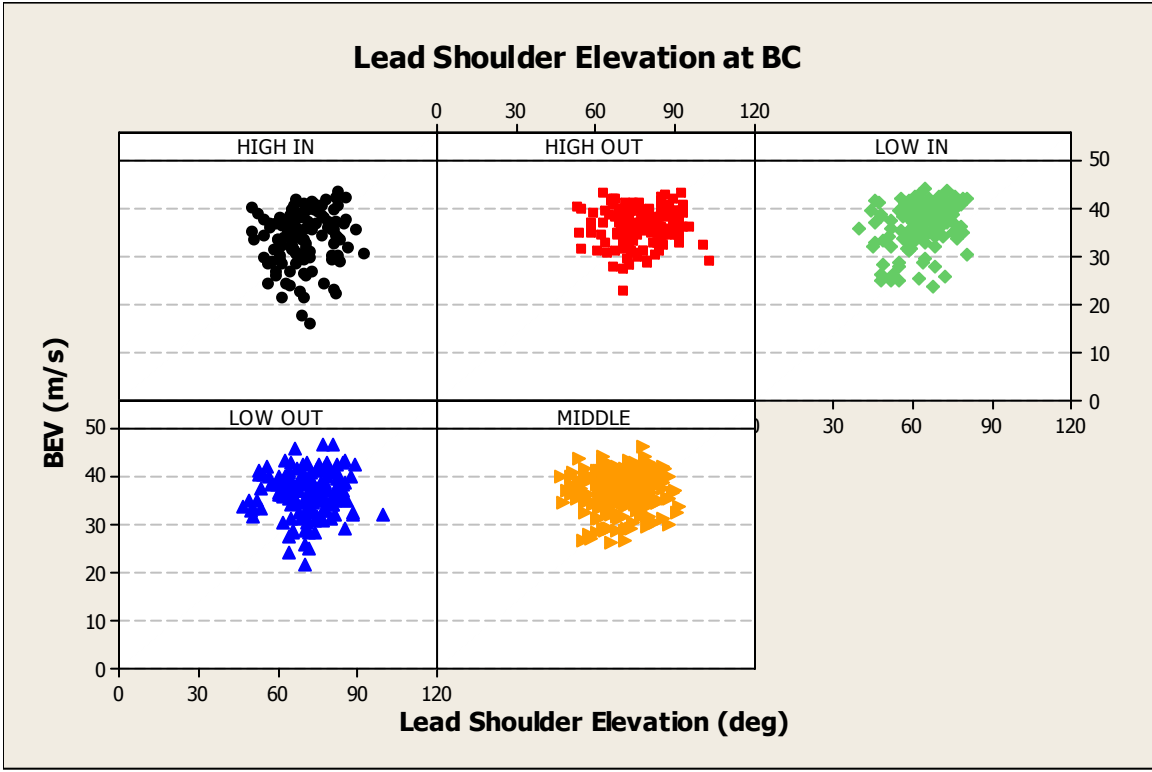

Figure 8. Lead shoulder elevation angle at BC across BEV (raw data)

Table 9. Analysis of variance for lead shoulder elevation angle at BC

Source	DF	Seq SS	Adj SS	Adj MS	F	P
Lead Shoulder Elevation	1	148.02	4.46	4.46	0.28	0.594
Subject	32	2703.86	867.58	27.11	1.73	0.008
Location	4	962.34	893.25	223.31	14.28	0.000
PS	1	155.67	0.11	0.11	0.01	0.933
Subject*PS	32	849.89	849.89	26.56	1.70	0.010
Error	775	12117.13	12117.13	15.64		
Total	845	16936.92				

As seen in Table 9, there was not a significant relationship between lead shoulder elevation angle at BC and BEV. Thus, no equation or graph of estimated BEV versus lead shoulder elevation angle at BC was developed.

## 4.2.2.5 Lead shoulder azimuth at BC

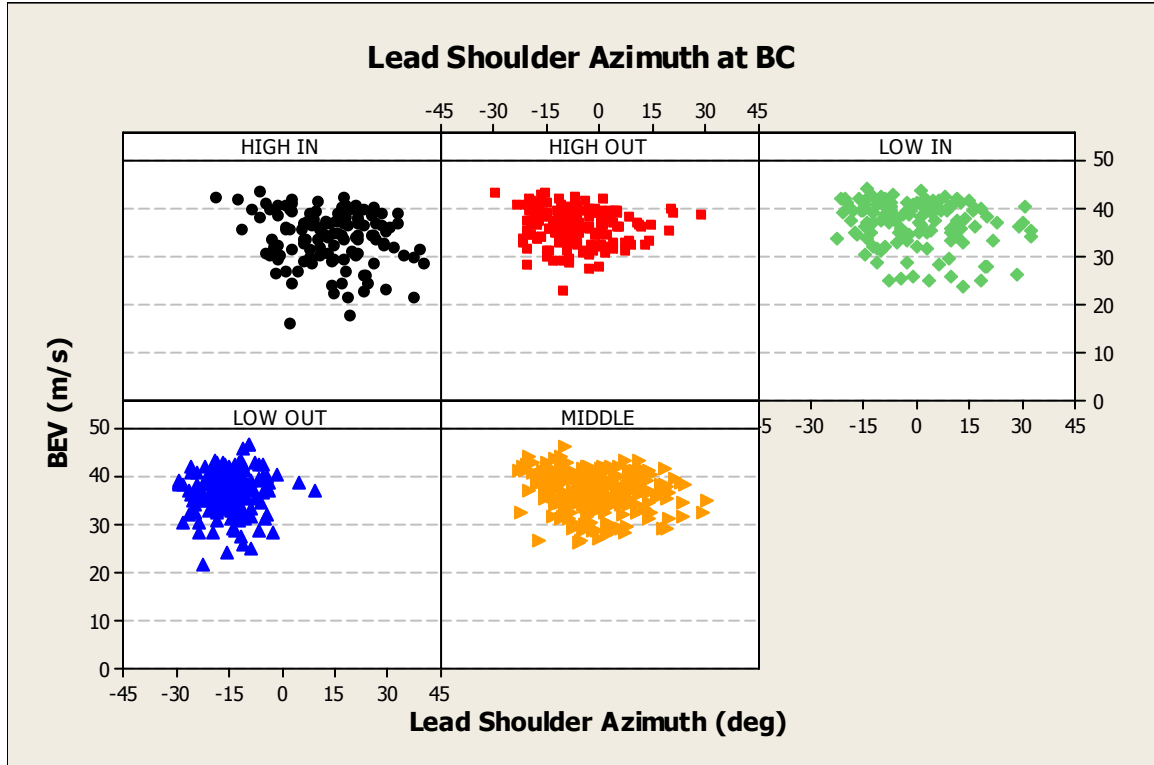

Figure 9. Lead shoulder azimuth at BC across BEV (raw data)

Table 10. Analysis of variance for lead shoulder azimuth at BC

Source	DF	Seq SS	Adj SS	Adj MS	F	P
Lead Shoulder Azimuth	1	681.84	130.79	130.79	8.65	0.003
Subject	32	2845.68	736.88	23.03	1.52	0.033
Location	4	665.24	193.61	48.40	3.20	0.013
PS	1	143.86	0.00	0.00	0.00	0.987
Location*Lead Shoulder Azimuth	4	162.04	147.94	36.98	2.45	0.045
Subject*PS	32	722.28	722.28	22.57	1.49	0.040
Error	769	11621.03	11621.03	15.11		
Total	843	16841.96				

$$Eq. 3: BEV = 33.99 - 0.06 * Lead\ Shoulder\ Azimuth_{BC} + A * \mu + B * LOC + 0.01 * PS + C * LOC * Lead\ Shoulder\ Azimuth_{BC} + D * \mu * PS$$

In Eq. 3, the ranges for the coefficients were A: [-113.00 to 93.01], B: [HIGH IN = -0.51, HIGH OUT = -0.50, LOW IN = -0.20, LOW OUT = 0.38], C: [HIGH IN = -0.08, HIGH OUT = 0.02, LOW IN = -0.01, LOW OUT = 0.09], and D: [-29.16 to

4.54]. In practicality, increases in BEV were associated with decreased lead shoulder azimuth at BC (i.e. less horizontal abduction) for HIGH IN, LOW IN, MIDDLE, and HIGH OUT and increased lead shoulder azimuth at BC (i.e. more horizontal abduction) for LOW OUT. According to the model, the difference between the minimum and maximum measured values of lead shoulder azimuth ( $-29.50^\circ$  to  $40.23^\circ$ , respectively) would lead to a BEV difference of  $-9.82$  m/s for HIGH IN,  $-4.82$  m/s for LOW IN,  $-3.92$  m/s for MIDDLE, and  $-2.69$  m/s for HIGH OUT, but  $+2.16$  m/s for LOW OUT. Figure 10 below visualizes the model-estimated BEV based on the range of measured values of lead shoulder azimuth at BC.

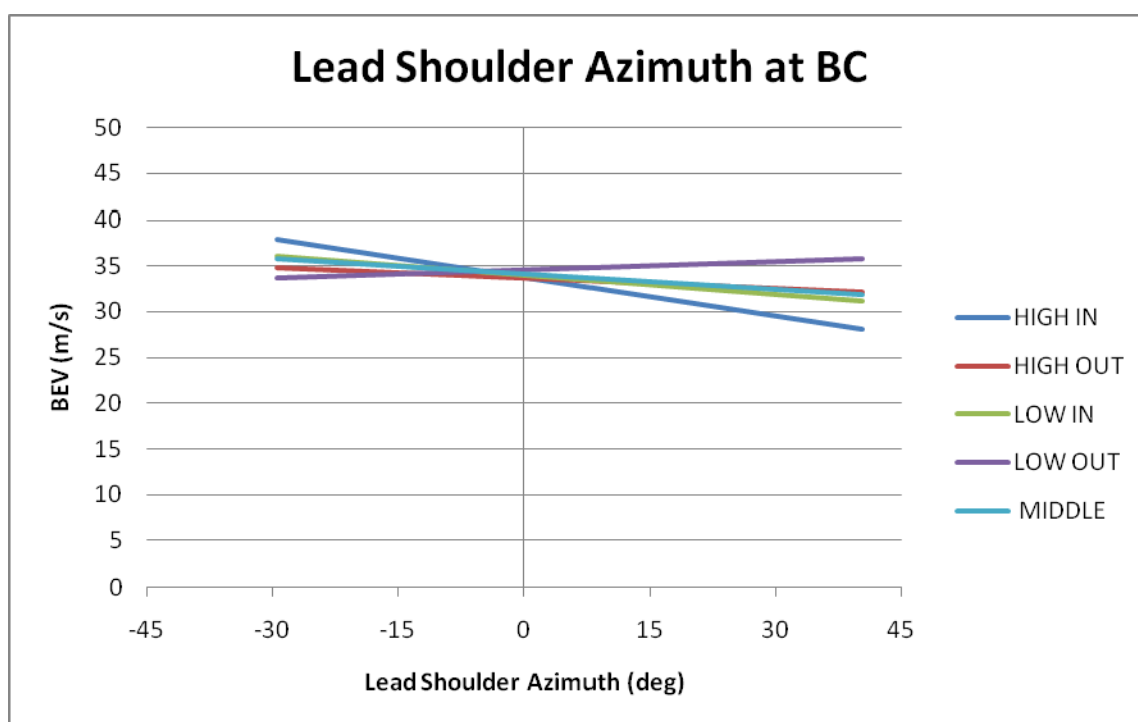

Figure 10. Model estimate of average BEV across values of lead shoulder azimuth at BC.

## 4.2.2.6 Trail elbow flexion at BC

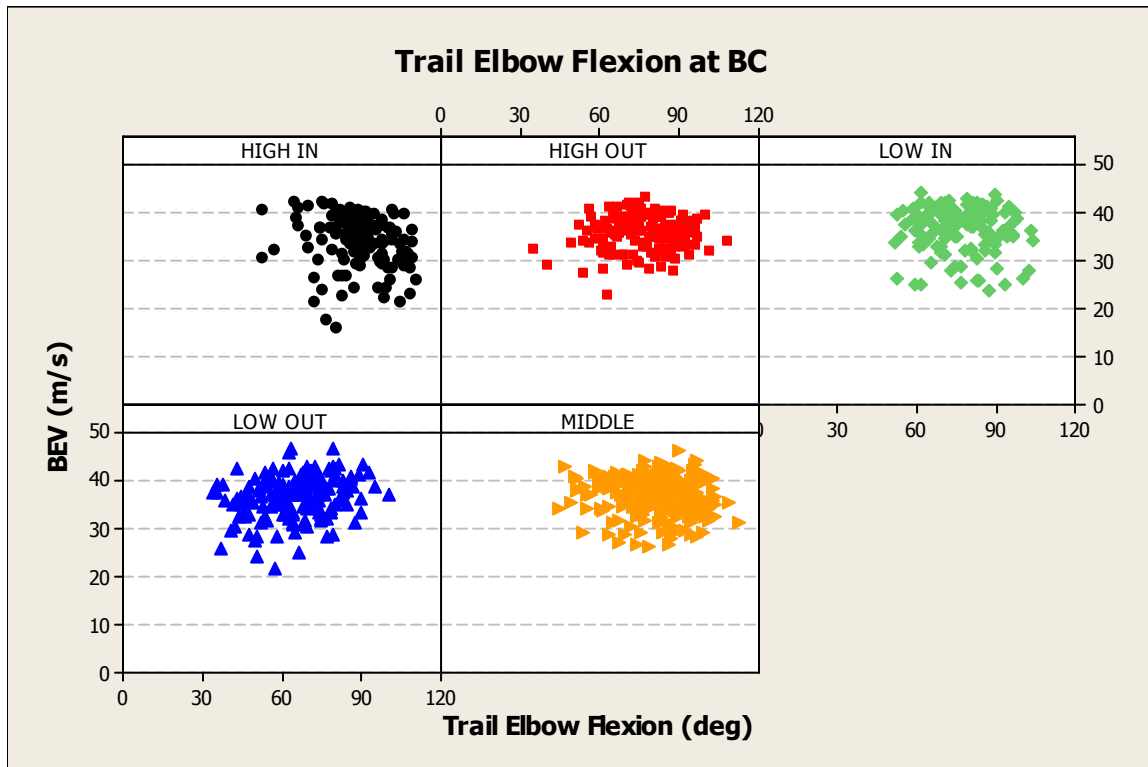

Figure 11. Trail elbow flexion angle at BC across BEV (raw data)

Table 11. Analysis of variance for trail elbow flexion angle at BC

Source	DF	Seq SS	Adj SS	Adj MS	F	P
Trail Elbow Flexion	1	41.71	199.70	199.70	13.45	0.000
Subject	31	2671.57	940.72	30.35	2.04	0.001
Location	4	827.74	399.82	99.95	6.73	0.000
PS	1	181.42	172.80	172.80	11.64	0.001
Subject*Trail Elbow Flexion	31	1084.25	1014.05	32.71	2.20	0.000
Location*Trail Elbow Flexion	4	378.56	378.56	94.64	6.38	0.000
Error	774	11490.01	11490.01	14.84		
Total	846	16675.26				

$$\text{Eq. 4: } BEV = 22.10 - 0.07 * \text{Trail Elbow Flexion}_{BC} + A * \mu + B * LOC + 0.78 * PS + C * \mu * \text{Trail Elbow Flexion}_{BC} + D * LOC * \text{Trail Elbow Flexion}_{BC}$$

In Eq. 4, the ranges for the coefficients were A: [-13.10 to 13.23], B: [HIGH IN = 7.60, HIGH OUT = -4.06, LOW IN = 0.33, LOW OUT = -6.90], C: [-0.29 to 0.30], and D: [HIGH IN = -0.10, HIGH OUT = 0.05, LOW IN = -0.01, LOW OUT = 0.09]. In

practicality, increases in BEV were associated with decreased trail elbow flexion at BC (i.e. more extended) for HIGH IN, LOW IN, and MIDDLE. According to the model, the difference between the minimum and maximum measured values of trail elbow flexion (33.92° to 112.24°, respectively) would lead to a BEV difference of -13.39 m/s for HIGH IN, -6.26 m/s for LOW IN, -5.35 m/s for MIDDLE, and -1.69 m/s for HIGH OUT, but +1.85 m/s for LOW OUT. Figure 12 below visualizes the model-estimated BEV based on the range of measured values of trail elbow flexion at BC.

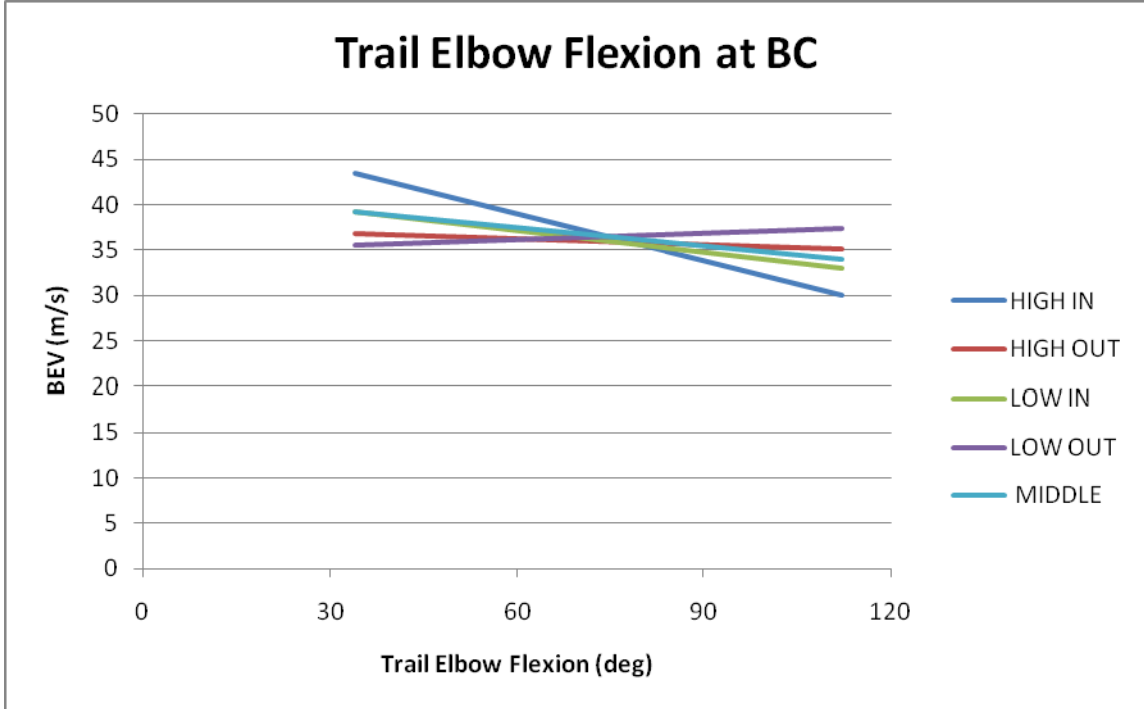

Figure 12. Model estimate of average BEV across values of trail elbow flexion at BC.

## 4.2.2.7 Bat lag at BC

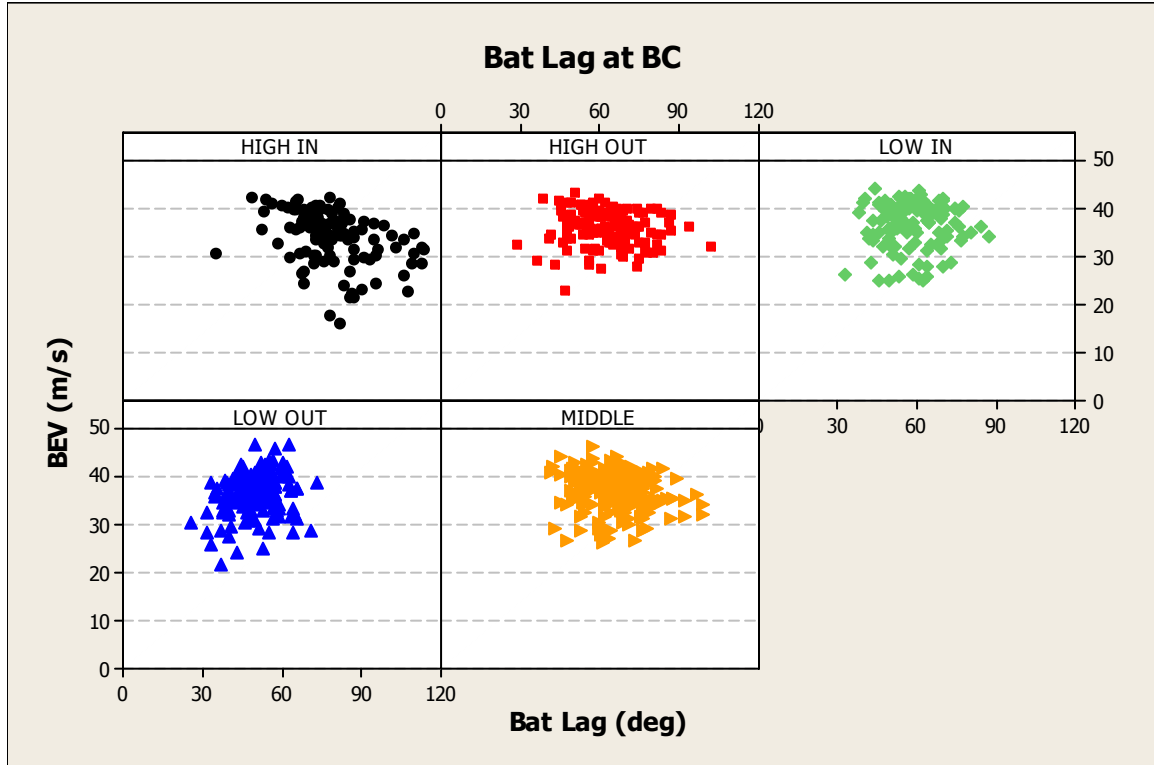

Figure 13. Bat lag angle at BC across BEV (raw data)

Table 12. Analysis of variance for bat lag angle at BC

Source	DF	Seq SS	Adj SS	Adj MS	F	P
Bat Lag	1	349.92	16.50	16.50	1.05	0.307
Subject	31	1875.59	2028.94	65.45	4.15	0.000
Location	4	627.67	576.72	144.18	9.14	0.000
PS	1	203.49	218.19	218.19	13.83	0.000
Location*Bat Lag	4	591.34	591.34	147.84	9.37	0.000
Error	712	11232.94	11232.94	15.78		
Total	753	14880.95				

$$\text{Eq. 5: } BEV = 14.33 - 0.02 * Bat Lag_{BC} + A * \mu + B * LOC + 0.94 * PS + C * LOC * Bat Lag_{BC}$$

In Eq. 5, the ranges for the coefficients were A: [-3.68 to 4.79], B: [HIGH IN = 7.52, HIGH OUT = -0.71, LOW IN = -2.42, LOW OUT = -8.29], and C: [HIGH IN = -0.12, HIGH OUT = -1.13e-3, LOW IN = 0.03, LOW OUT = 0.15]. In practicality, increases in BEV were associated with decreased bat lag at BC for HIGH IN and



increased bat lag at BC for LOW OUT. According to the model, the difference between the minimum and maximum values of bat lag would lead to a BEV difference of  $-12.35$  m/s for HIGH IN,  $-1.51$  m/s for HIGH OUT,  $-1.41$  m/s for MIDDLE,  $+1.00$  m/s for LOW IN, and  $+11.70$  m/s for LOW OUT. Figure 14 below visualizes the model-estimated BEV based on the range of measured values of bat lag at BC ( $25.64^\circ$  to  $113.67^\circ$ ).

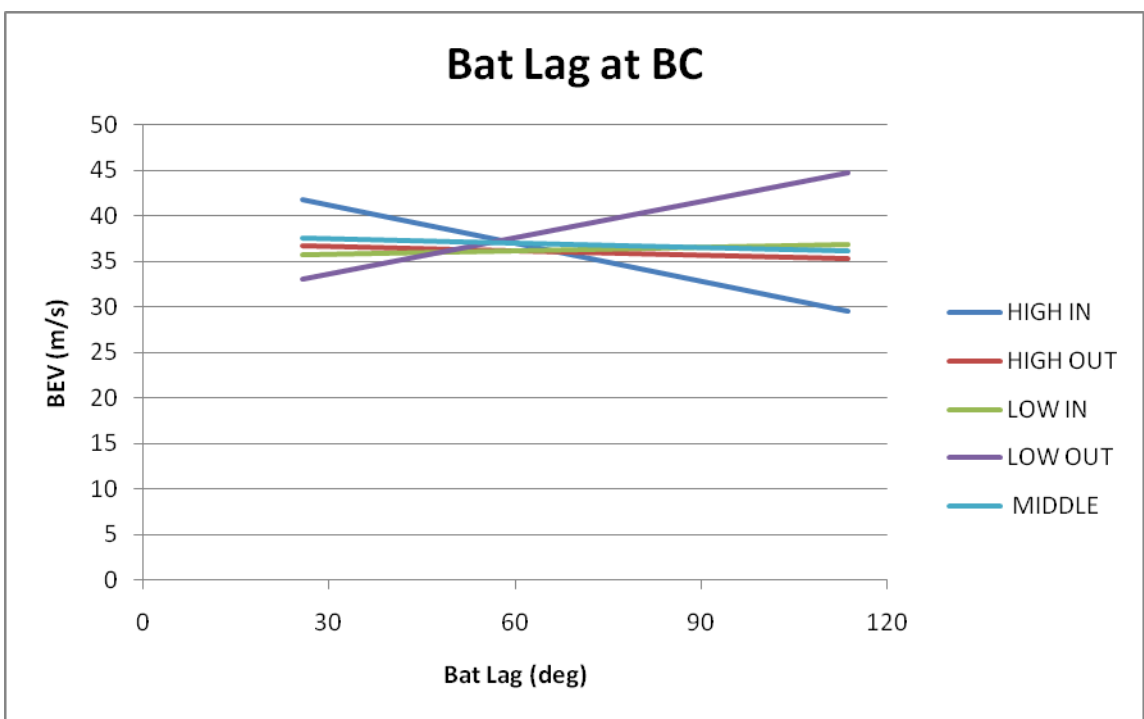

Figure 14. Model estimate of average BEV across values of bat lag angle at BC.

4.2.2.8 Bat elevation at BC

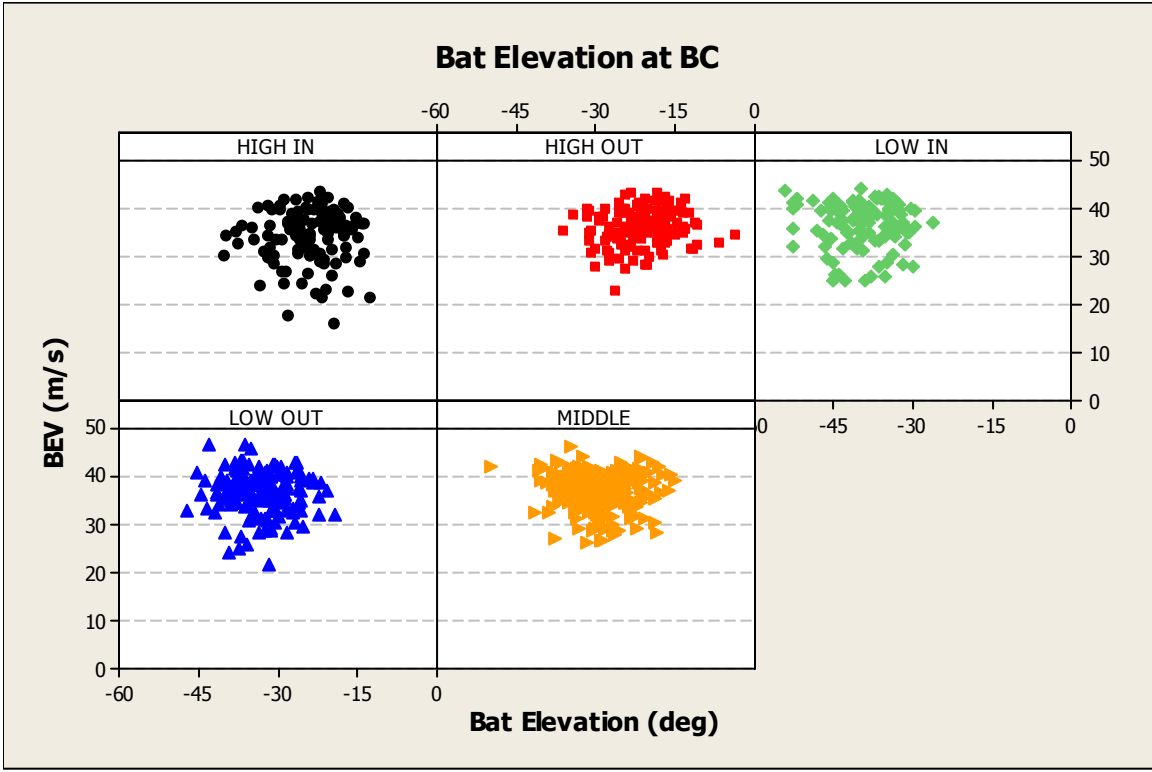

Figure 15. Bat elevation angle at BC across BEV (raw data)

Table 13. Analysis of variance for bat elevation angle at BC

Source	DF	Seq SS	Adj SS	Adj MS	F	P
Bat Elevation	1	76.92	0.05	0.05	0.00	0.957
Subject	32	2350.97	801.29	25.04	1.56	0.026
Location	4	763.81	763.22	190.81	11.92	0.000
PS	1	166.29	80.78	80.78	5.05	0.025
Subject*PS	32	778.71	778.71	24.33	1.52	0.034
Error	711	11381.74	11381.74	16.01		
Total	781	15518.44				

As seen in Table 13, there was not a significant relationship between bat elevation angle at BC and BEV. Thus, no equation or graph of estimated BEV versus lead shoulder elevation angle at BC was developed.

## 4.2.2.9 Bat azimuth

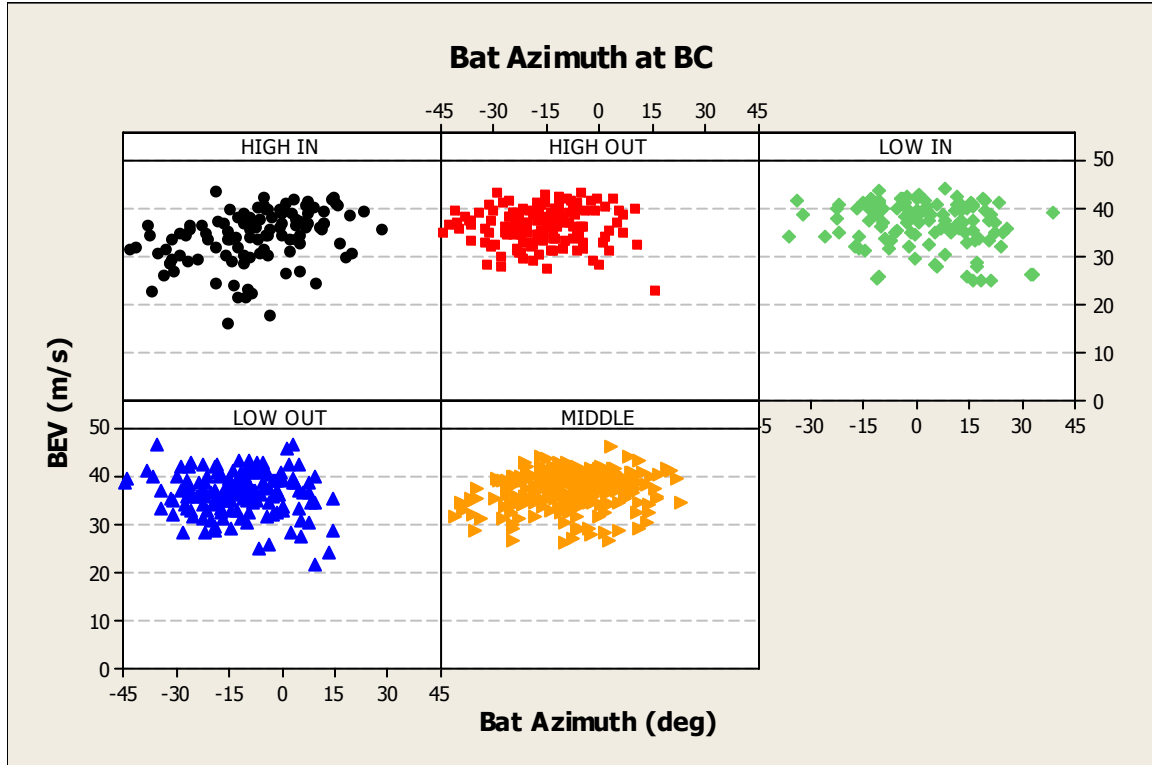

Figure 16. Bat azimuth at BC across BEV (raw data)

Table 14. Analysis of variance for bat azimuth at BC

Source	DF	Seq SS	Adj SS	Adj MS	F	P
Bat Azimuth	1	64.64	34.54	34.54	2.24	0.135
Subject	32	2327.36	2375.33	74.23	4.81	0.000
Location	4	830.16	541.73	135.43	8.77	0.000
PS	1	179.92	159.22	159.22	10.31	0.001
Location*Bat Azimuth	4	587.69	587.69	146.92	9.52	0.000
Error	737	11380.06	11380.06	15.44		
Total	779	15369.84				

$$Eq. 6: BEV = 15.24 + 0.02 * Bat\ Azimuth_{BC} + A * \mu + B * LOC + 0.85 * PS + C * LOC * Bat\ Azimuth_{BC}$$

In Eq. 6, the ranges for the coefficients were A: [-3.61 to 3.89], B: [HIGH IN = -1.07, HIGH OUT = 0.13, LOW IN = 0.02, LOW OUT = -0.68], and C: [HIGH IN = 0.11, HIGH OUT = -2.23e-3, LOW IN = -0.07, LOW OUT = -0.08]. In practicality, increases in BEV were associated with decreased bat azimuth at BC for LOW IN and

LOW OUT and with increased bat azimuth at BC for HIGH IN. According to the model, the difference between the minimum and maximum measured values of bat azimuth ( $-44.30^\circ$  and  $38.70^\circ$ , respectively) would lead to a BEV difference of  $-4.95$  m/s for LOW OUT,  $-3.97$  m/s for LOW IN,  $+1.31$  m/s for HIGH OUT,  $+1.49$  for MIDDLE, and  $+10.58$  m/s for HIGH IN. Figure 17 below visualizes the model-estimated BEV based on the range of measured values of bat azimuth at BC.

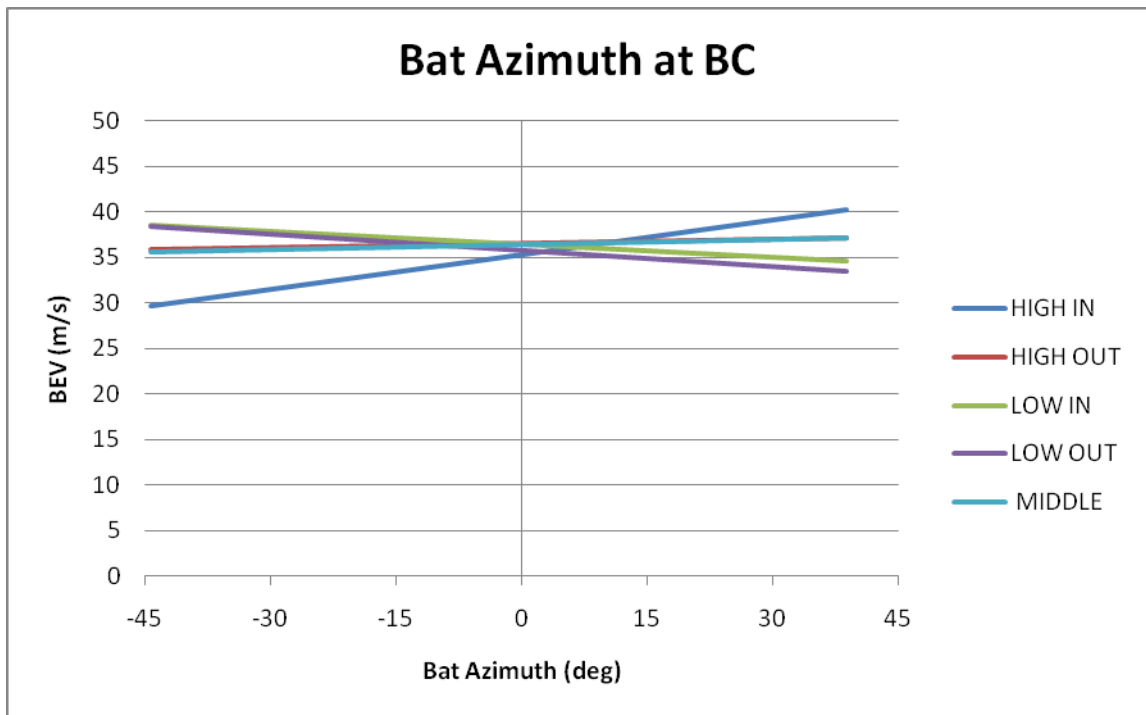

Figure 17. Model estimate of average BEV across values of bat azimuth at BC.

## 4.2.2.10 Head rotation at BC

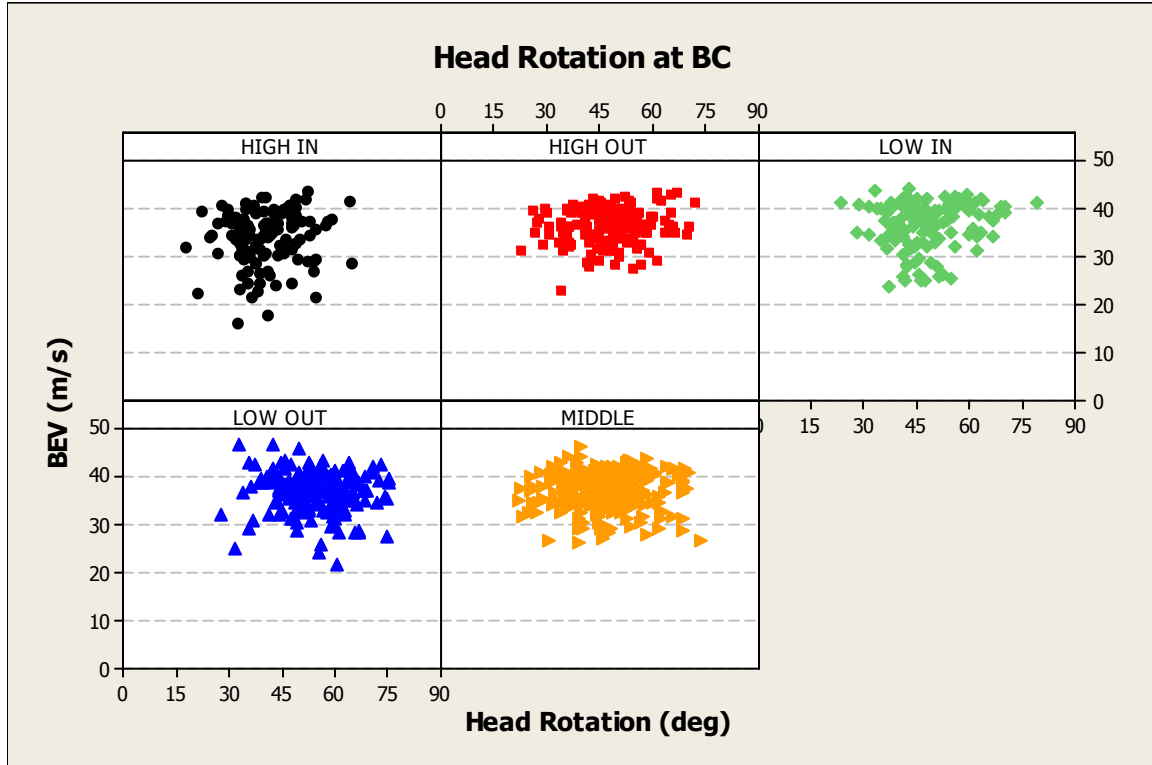

Figure 18. Head rotation angle at BC across BEV (raw data)

Table 15. Analysis of variance for head rotation angle at BC

Source	DF	Seq SS	Adj SS	Adj MS	F	P
Head Rotation	1	140.00	2.05	2.05	0.13	0.714
Subject	31	3003.34	862.38	27.82	1.83	0.004
Location	4	767.04	721.17	180.29	11.83	0.000
PS	1	154.15	164.83	164.83	10.82	0.001
Subject*Head Rotation	31	759.87	835.24	26.94	1.77	0.007
Subject*PS	31	828.32	828.32	26.72	1.75	0.007
Error	749	11411.58	11411.58	15.24		
Total	848	17064.30				

$$\text{Eq. 7: } BEV = 9.59 + 0.01 * \text{Head Rotation}_{BC} + A * \mu + B * LOC + 1.01 * PS + C * \mu * \text{Head Rotation}_{BC} + D * \mu * PS$$

In Eq. 7, the ranges for the coefficients were A: [-102.71 to 105.41], B: [HIGH IN = -1.68, HIGH OUT = 0.17, LOW IN = 0.02, LOW OUT = 0.06], C: [-0.26 to 0.25], and D: [-4.00 to 4.57]. In practicality, there was no significant group-wise association between head rotation at BC and BEV. According to the model, the difference between

the minimum and maximum measured values of head rotation (17.64° and 79.21°, respectively) would lead to a BEV difference of +0.64 m/s. Figure 19 below visualizes the model-estimate BEV based on the range of measured values of head rotation at BC.

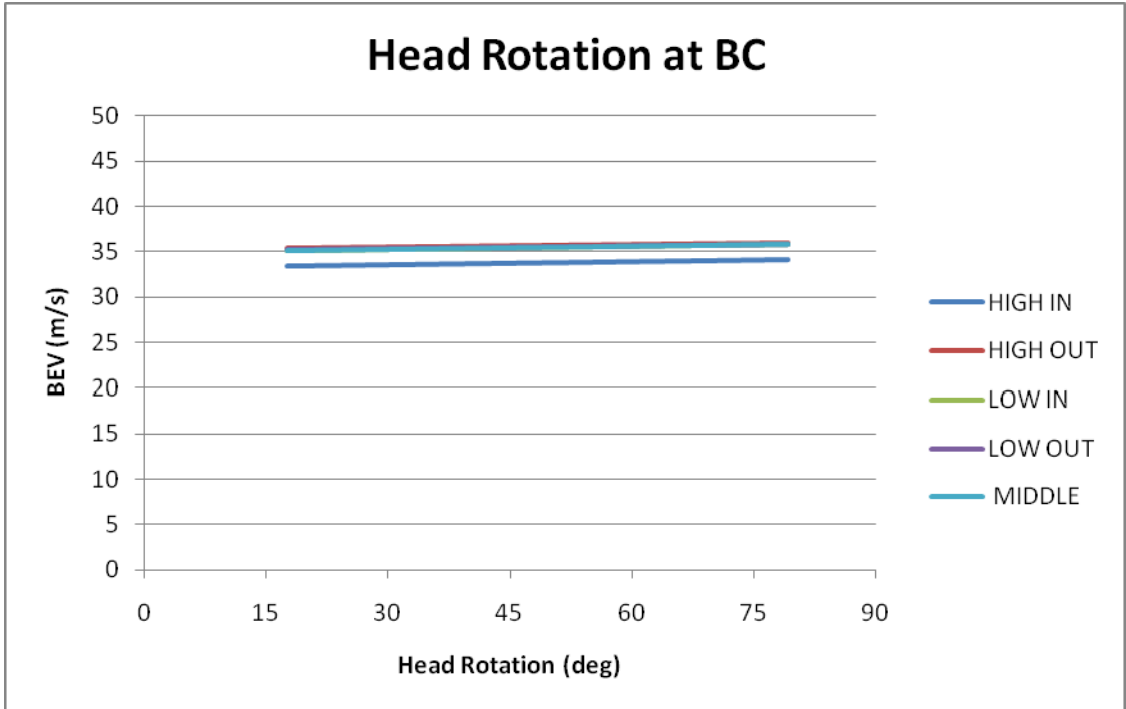

Figure 19. Model estimate of average BEV across values of head rotation angle at BC.

## 4.2.2.11 Time of peak lead knee extension velocity

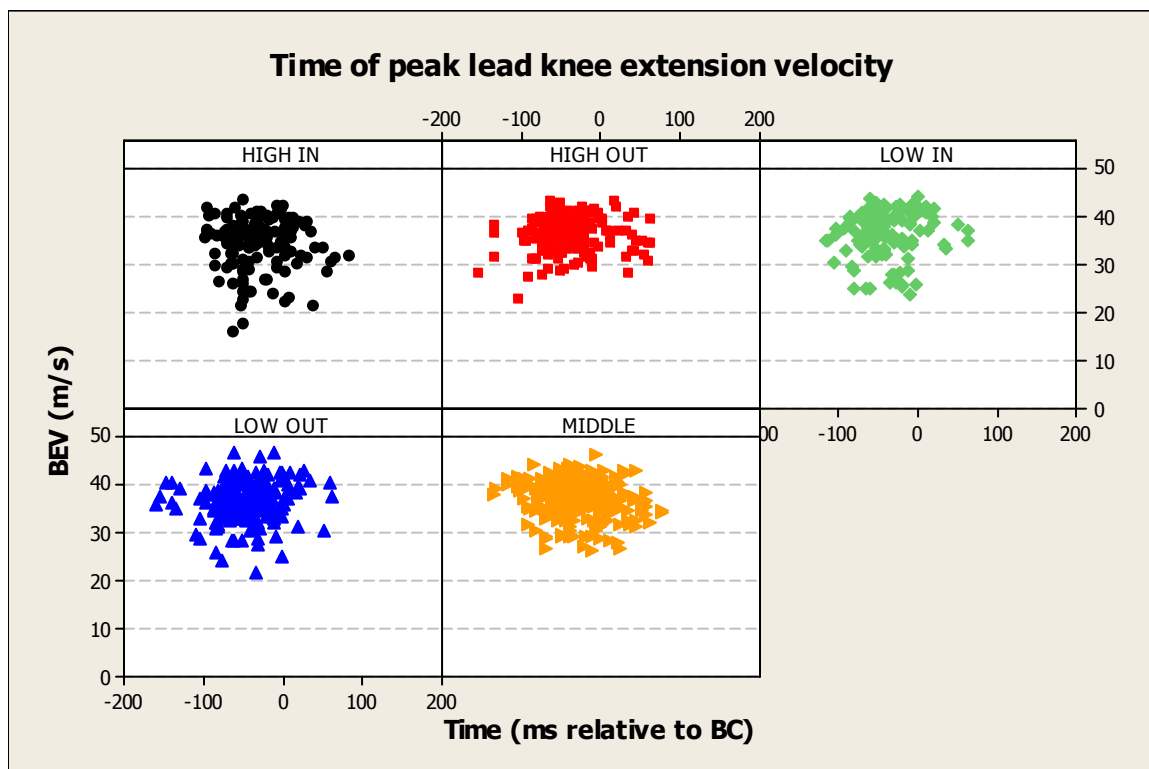

Figure 20. Time of peak lead knee extension velocity across BEV (raw data)

Table 16. Analysis of variance for time of peak lead knee extension velocity

Source	DF	Seq SS	Adj SS	Adj MS	F	P
Knee time	1	0.07	0.11	0.11	0.01	0.934
Subject	32	2827.61	769.03	24.03	1.53	0.031
Location	4	972.15	878.91	219.73	14.01	0.000
PS	1	165.14	169.15	169.15	10.79	0.001
Subject*PS	32	751.43	751.43	23.48	1.50	0.039
Error	792	12419.66	12419.66	15.68		
Total	862	17136.06				

As seen in Table 16, there was not a significant relationship between the time of peak lead knee extension velocity and BEV. Thus no equation or graph of estimated BEV versus time of peak lead knee extension velocity was developed.

## 4.2.2.12 Time of peak pelvis rotation velocity

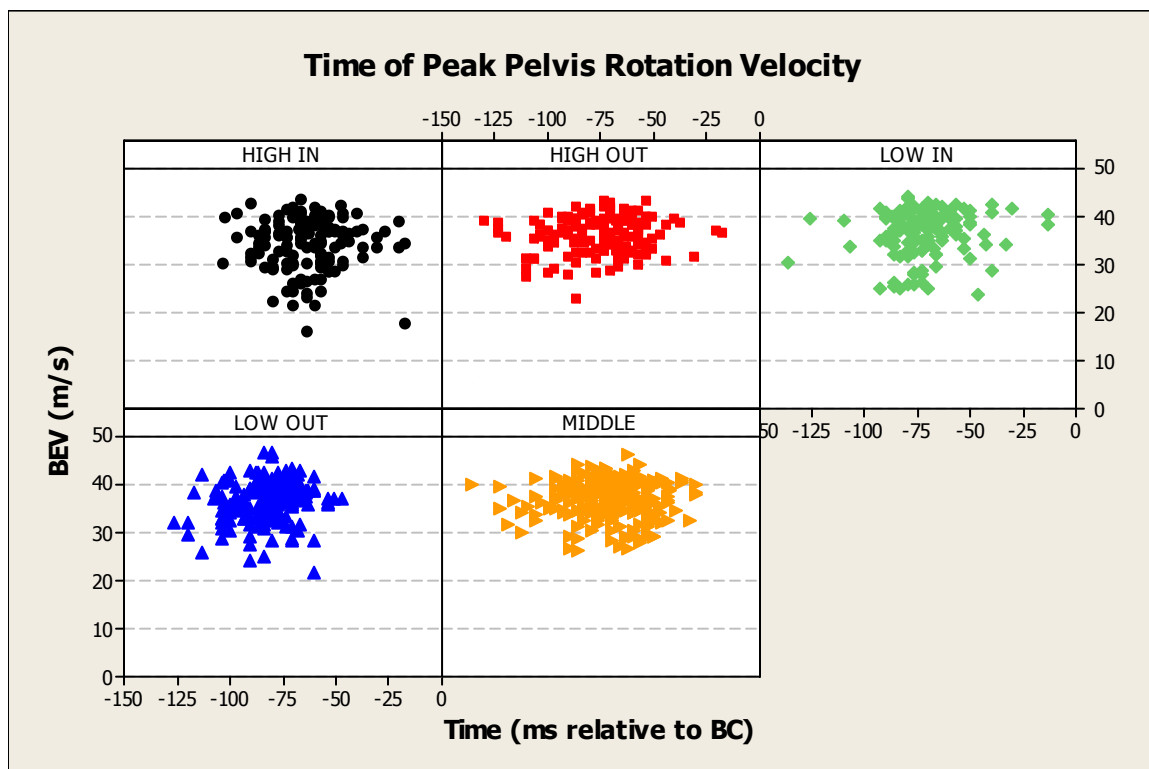

Figure 21. Time of peak pelvis rotation velocity across BEV (raw data)

Table 17. Analysis of variance for time of peak pelvis rotation velocity

Source	DF	Seq SS	Adj SS	Adj MS	F	P
Pelvis time	1	7.70	7.69	7.69	0.50	0.482
Subject	32	2780.32	794.56	24.83	1.60	0.020
Location	4	939.68	839.18	209.80	13.53	0.000
PS	1	160.18	155.63	155.63	10.04	0.002
Subject*PS	32	775.19	775.19	24.22	1.56	0.026
Error	797	12360.35	12360.35	15.51		
Total	867	17023.41				

As seen in Table 17, there was not a significant relationship between the time of peak pelvis rotation velocity and BEV. Thus no equation or graph of estimated BEV versus time of peak pelvis rotation velocity was developed.



## 4.2.2.13 Time of peak upper trunk rotation velocity

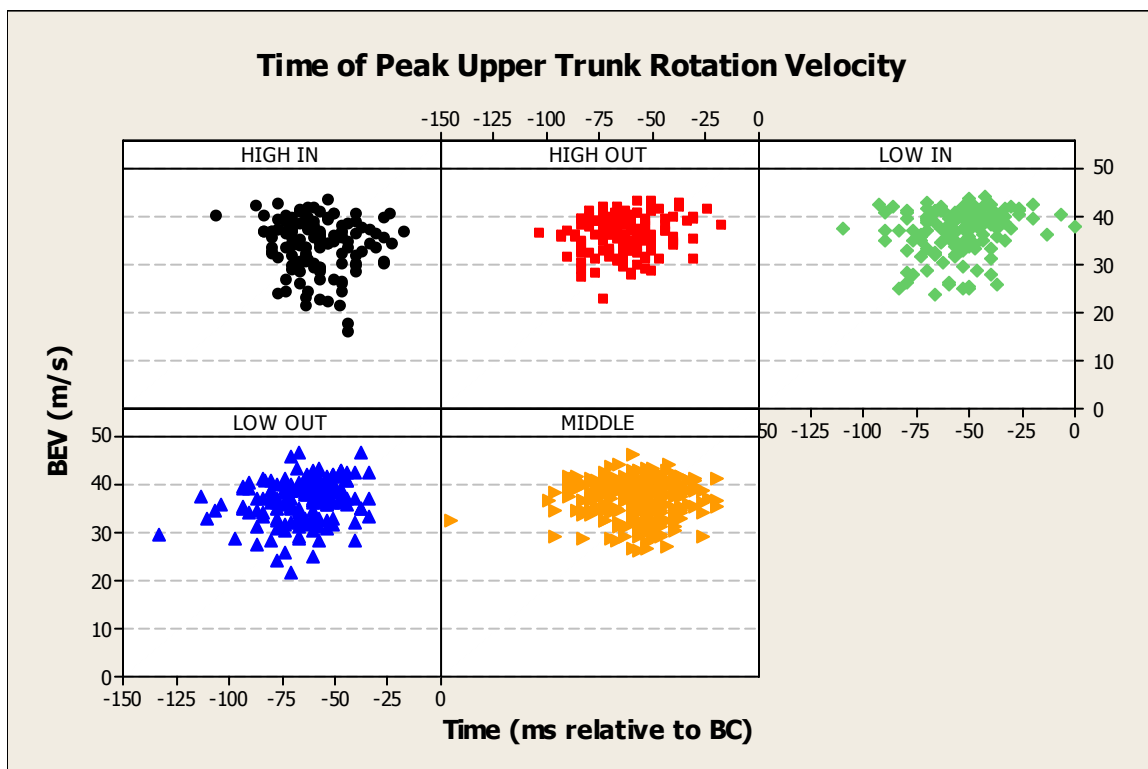

Figure 22. Time of peak upper trunk rotation velocity across BEV (raw data)

Table 18. Analysis of variance for time of peak upper trunk rotation velocity

Source	DF	Seq SS	Adj SS	Adj MS	F	P
Upper Trunk time	1	67.58	3.96	3.96	0.26	0.612
Subject	32	2831.89	755.21	23.60	1.54	0.030
Location	4	929.59	367.44	91.86	5.98	0.000
PS	1	122.88	149.03	149.03	9.71	0.002
Location*Upper Trunk time	4	324.69	287.85	71.96	4.69	0.001
Subject*PS	32	734.06	734.06	22.94	1.49	0.040
Error	791	12145.48	12145.48	15.35		
Total	865	17156.17				

$$Eq. 8: BEV = 12.30 + 5.21e-3 * Upper Trunk Rotation Velocity_{time} + A * \mu + B * LOC + 0.94 * PS + C * LOC * Upper Trunk Rotation Velocity_{time} + D * \mu * PS$$

In Eq. 8, the ranges for the coefficients were A: [-95.52 to 80.60], B: [HIGH IN = -5.10, HIGH OUT = 1.04, LOW IN = 0.42, LOW OUT = 4.03], and C: [HIGH IN = -0.05, HIGH OUT = 0.01, LOW IN = 0.01, LOW OUT = 0.06]. In practicality,

increases in BEV were associated with an earlier (relative to the time of BC) peak upper trunk rotation velocity for HIGH IN and with a later peak upper trunk rotation velocity for HIGH OUT and LOW OUT. According to the model, the difference between the minimum and maximum measured of values of the time of peak upper trunk rotation velocity ( $-146.67$  ms and  $0.00$  ms, respectively) would lead to a BEV difference of  $-7.11$  m/s for HIGH IN,  $+0.76$  m/s for MIDDLE,  $+1.95$  m/s for LOW IN,  $+2.96$  m/s for HIGH OUT,  $+9.45$  m/s for LOW OUT. Figure 23 below visualizes the model-estimated BEV based on the range of measured values of the time of peak upper trunk rotation velocity.

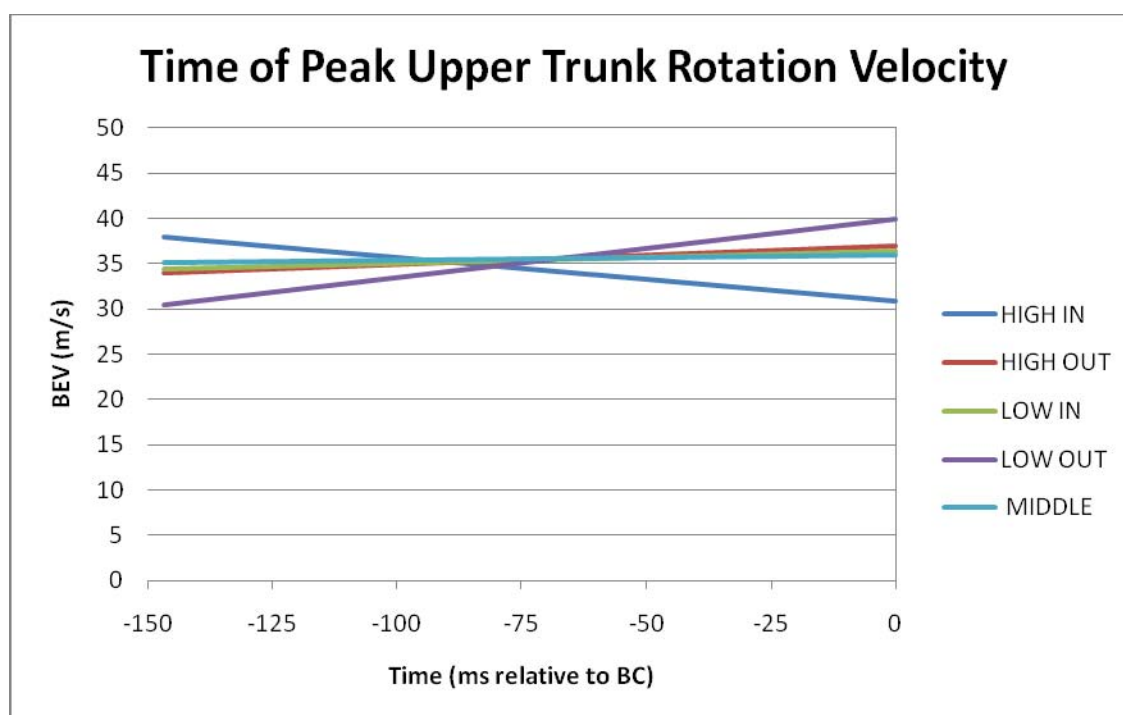

Figure 23. Model estimate of average BEV across values of time of peak upper trunk rotation velocity.

## 4.2.2.14 Time of peak lead shoulder azimuth velocity

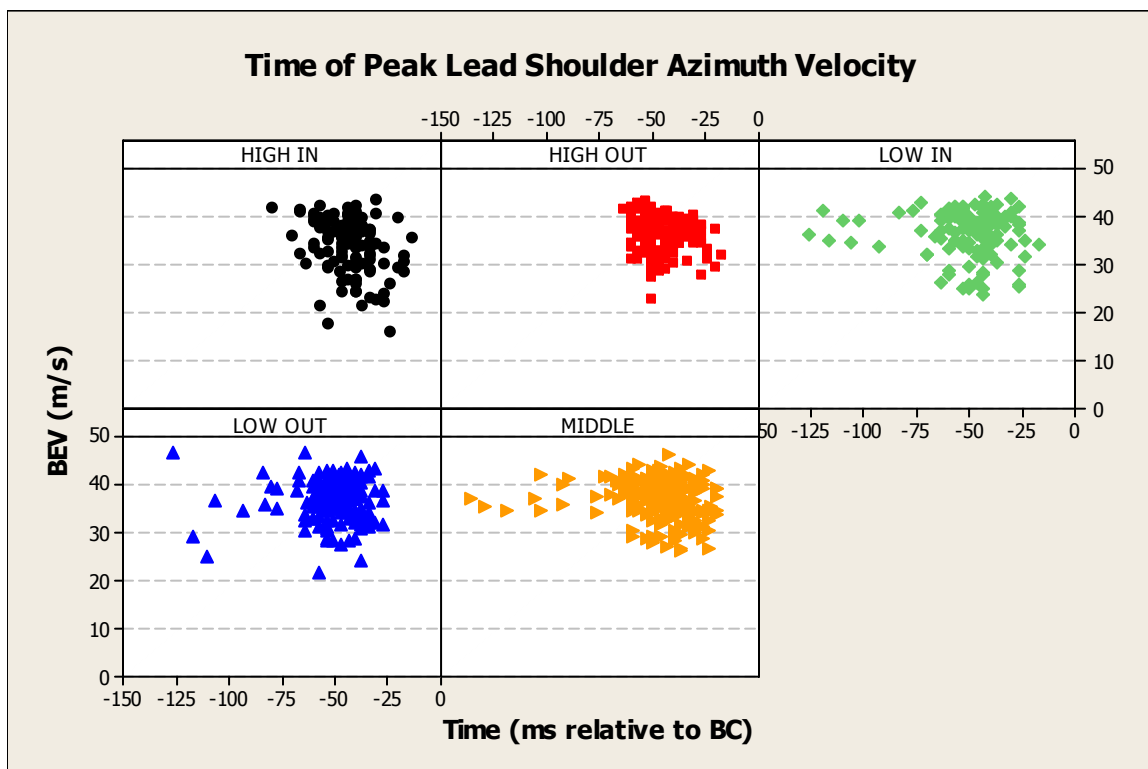

Figure 24. Time of peak lead shoulder azimuth velocity across BEV (raw data)

Table 19. Analysis of variance for time of peak lead shoulder azimuth velocity

Source	DF	Seq SS	Adj SS	Adj MS	F	P
Lead Shoulder Azimuth time	1	309.53	179.64	179.64	11.45	0.001
Subject	31	2766.04	2784.96	89.84	5.73	0.000
Location	4	820.13	737.84	184.46	11.76	0.000
PS	1	158.00	299.59	299.59	19.10	0.000
PS*Lead Shoulder Azimuth time	1	164.87	164.87	164.87	10.51	0.001
Error	799	12531.60	12531.60	15.68		
Total	837	16750.18				

$$Eq. 9: BEV = -19.39 - 0.75 * Lead\ Shoulder\ Azimuth\ Velocity_{time} + A * \mu + B * LOC + 2.13 * PS + 0.03 * PS * Lead\ Shoulder\ Azimuth\ Velocity_{time}$$

In Eq. 9, the ranges for the coefficients were A: [-4.17 to 3.98] and B: [HIGH IN = -1.74, HIGH OUT = 0.28, LOW IN = -0.02, LOW OUT = 0.23]. In practicality, increases in BEV were associated an earlier (relative to the time of BC) peak lead shoulder azimuth velocity for all pitch locations, but this effect was only true at low and

medium PS. According to the model, the difference between the minimum and maximum measured values of the time of peak lead shoulder azimuth velocity ( $-136.67$  ms and  $-13.33$  ms, respectively) would lead to a BEV difference of  $-12.25$  m/s at three standard deviations below the mean PS ( $23.2$  m/s),  $-5.98$  m/s at the mean PS ( $25.0$  m/s), and  $+0.30$  m/s at three standard deviations above the mean PS ( $26.8$  m/s) for all pitch locations. Figures 25-27 below visualize the model-estimated BEV based on the range of measured values of the time of peak lead shoulder azimuth velocity for low (i.e. mean  $- 3$  SD) PS, medium (i.e. mean) PS, and high (i.e. mean  $+ 3$  SD) PS.

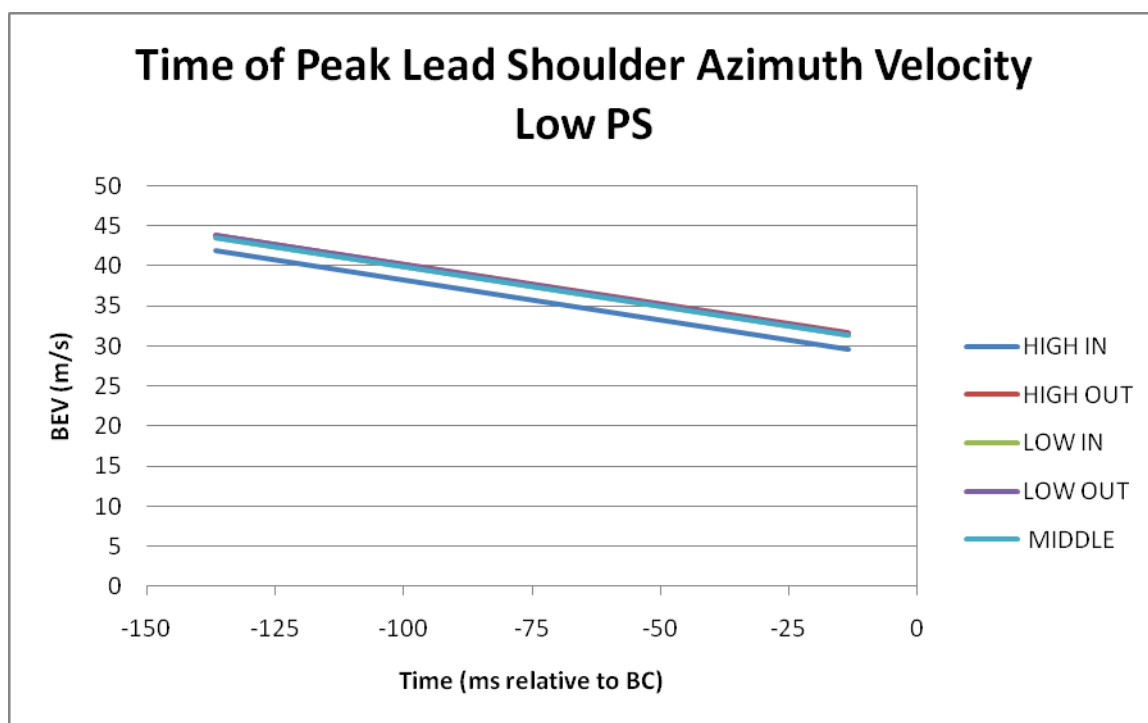

Figure 25. Model estimate of average BEV across values of time of peak lead shoulder azimuth velocity at low PS.

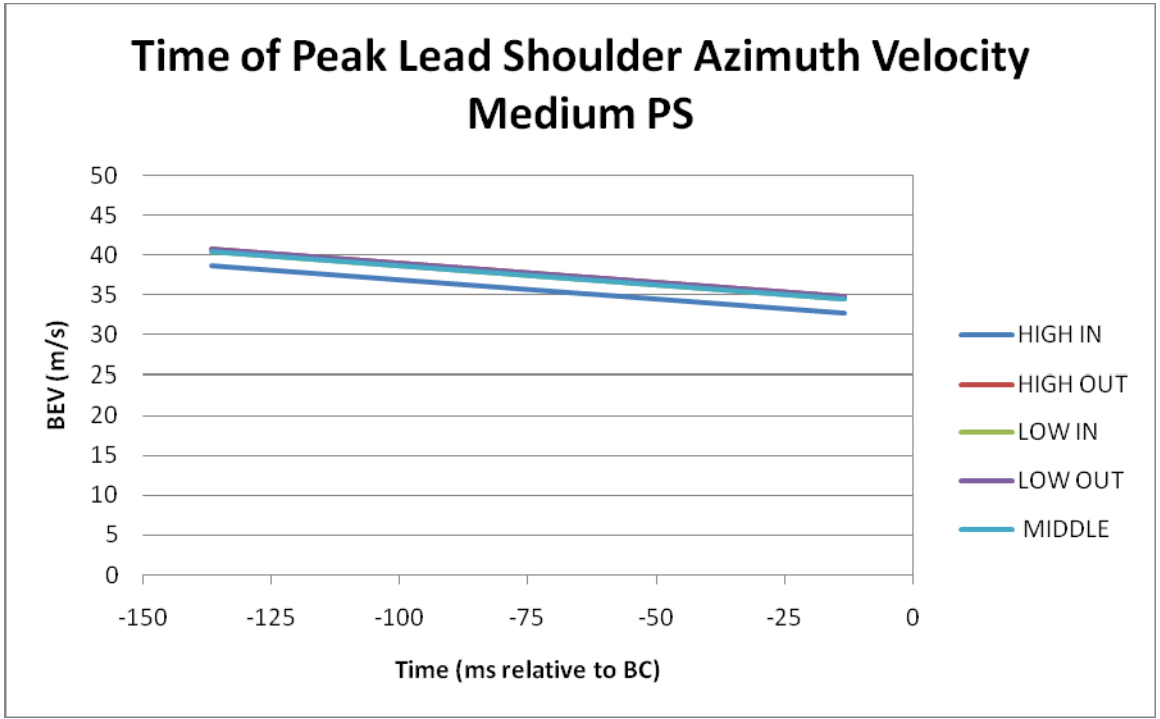

Figure 26. Model estimate of average BEV across values of time of peak lead shoulder azimuth velocity at medium PS.

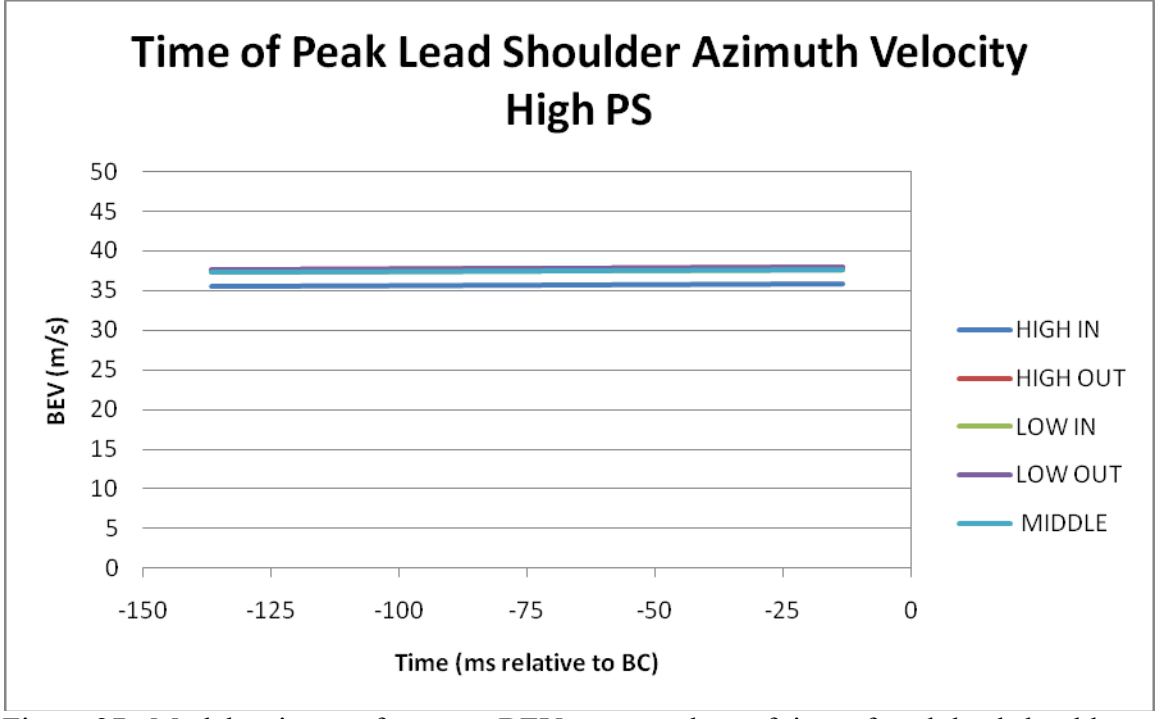

Figure 27. Model estimate of average BEV across values of time of peak lead shoulder azimuth velocity at high PS.

## 4.2.2.15 Time of peak trail elbow extension velocity

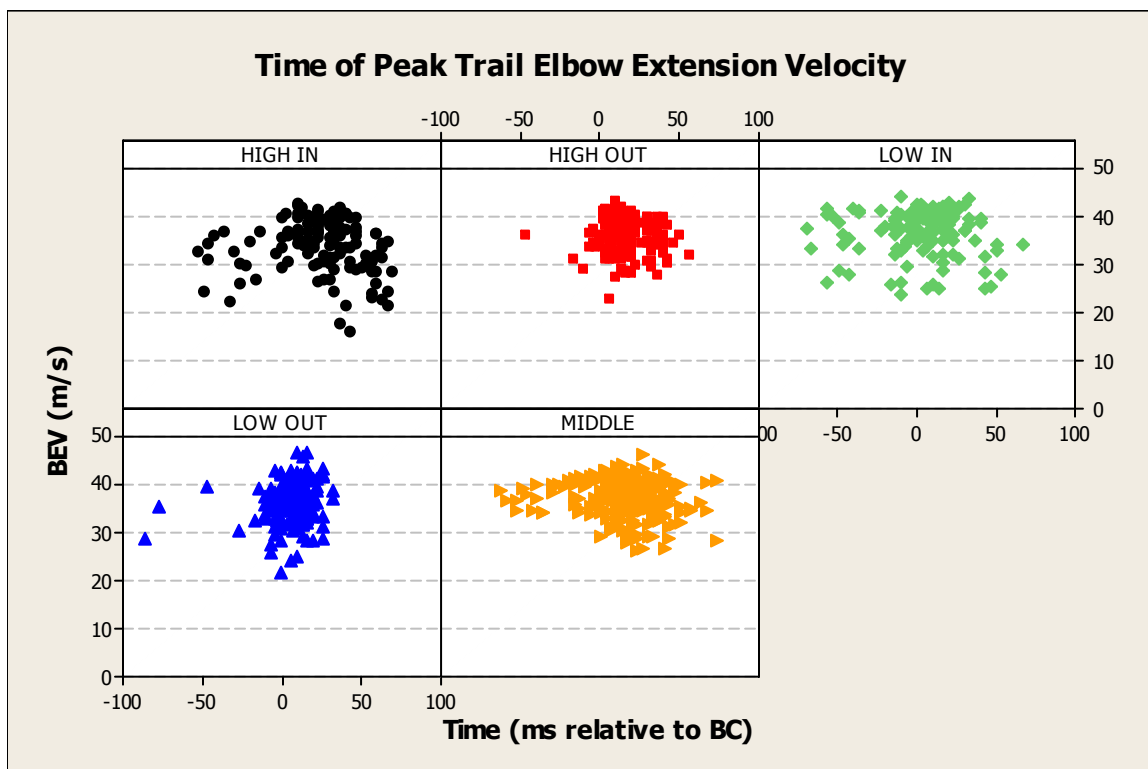

Figure 28. Time of peak trail elbow extension velocity across BEV (raw data)

Table 20. Analysis of variance for time of peak trail elbow extension velocity

Source	DF	Seq SS	Adj SS	Adj MS	F	P
Trail Elbow Ext time	1	118.08	5.13	5.13	0.32	0.570
Subject	32	2561.06	2619.84	81.87	5.16	0.000
Location	4	843.26	585.65	146.41	9.23	0.000
PS	1	167.10	151.12	151.12	9.53	0.002
Location*Trail Elbow Ext time	4	225.17	225.17	56.29	3.55	0.007
Error	797	12637.59	12637.59	15.86		
Total	839	16552.26				

$$Eq. 10: BEV = 18.72 - 0.01 * Trail\ Elbow\ Extension\ Velocity_{time} + A * \mu + B * LOC + 0.71 * PS + C * LOC * Trail\ Elbow\ Extension\ Velocity_{time}$$

In Eq. 10, the ranges for the coefficients were A: [-4.24 to 4.64], B: [HIGH IN = -1.57, HIGH OUT = 0.30, LOW IN = 0.01, LOW OUT = -0.35], and C: [HIGH IN = -0.01, HIGH OUT = -0.02, LOW IN = 3.60e-4, LOW OUT = 0.06]. In practicality, increases in BEV were associated with earlier (relative to the time of BC) peak trail

elbow extension velocity for HIGH IN and HIGH OUT and later peak trail elbow extension velocity for LOW OUT. According to the model, the difference between the minimum and maximum measured values of the time of peak trail elbow extension velocity ( $-86.67$  ms and  $+73.33$  ms, respectively) would lead to a BEV difference of  $-4.64$  m/s for HIGH OUT,  $-3.19$  m/s for HIGH IN,  $-0.88$  m/s for LOW IN,  $-0.82$  m/s for MIDDLE, and  $+9.54$  m/s for LOW OUT. Figure 29 below visualizes the model-estimated BEV based on the range of measured values of the time of peak trail elbow extension velocity.

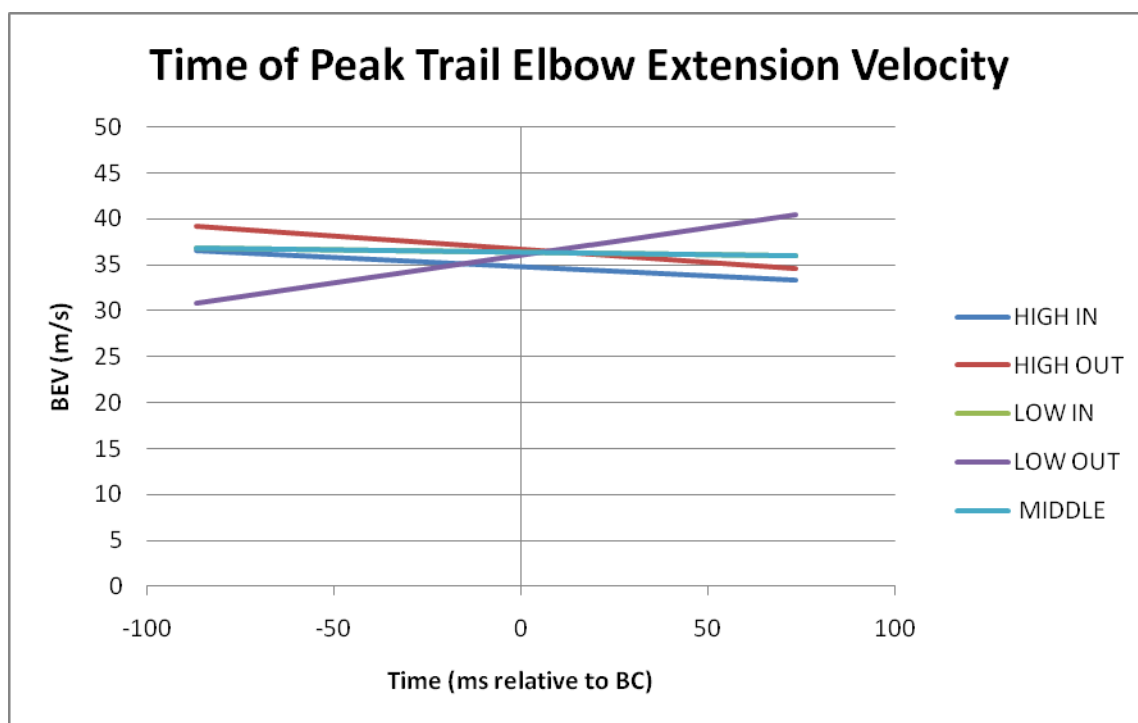

Figure 29. Model estimate of average BEV across values of time of peak trail elbow extension velocity.

## 4.2.2.16 Time of peak lead bat azimuth velocity

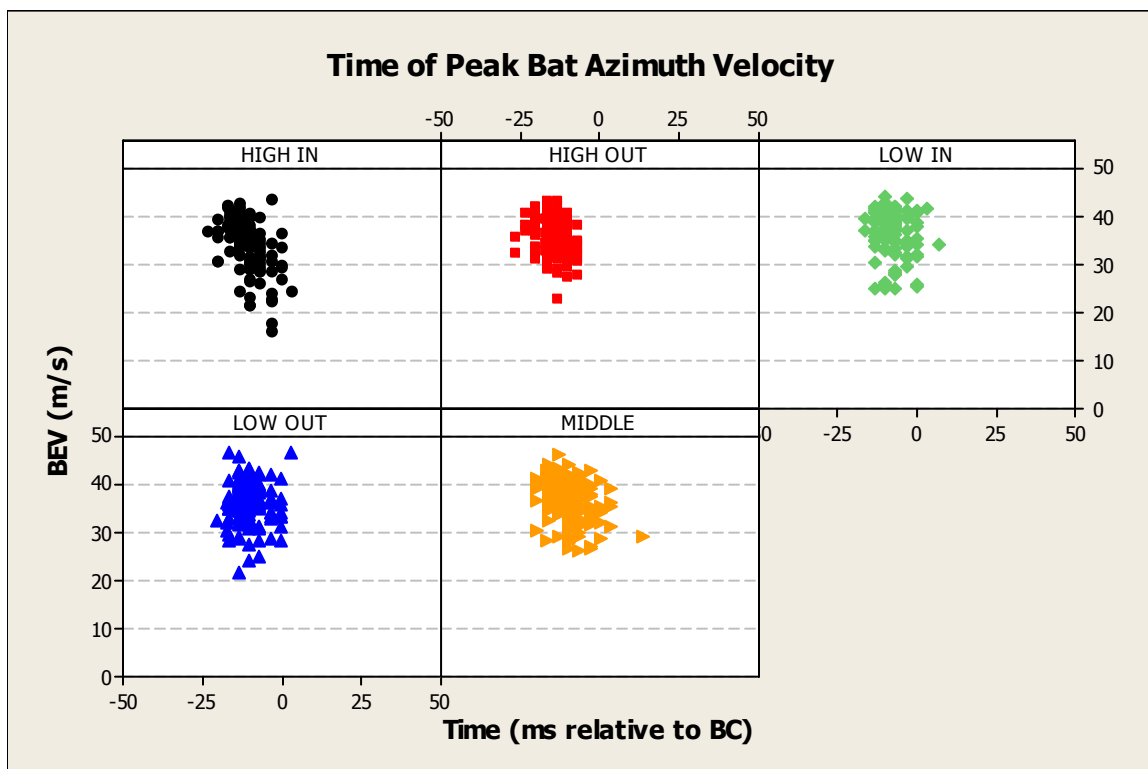

Figure 30. Time of peak bat azimuth velocity across BEV (raw data)

Table 21. Analysis of variance for time of peak bat azimuth velocity

Source	DF	Seq SS	Adj SS	Adj MS	F	P
Bat Azimuth time	1	657.60	1008.34	1008.34	72.65	0.000
Subject	32	2282.65	2391.43	74.73	5.38	0.000
Location	4	1100.38	768.49	192.12	13.84	0.000
PS	1	344.68	334.82	334.82	24.12	0.000
Location*Bat Azimuth time	4	434.16	434.16	108.54	7.82	0.000
Error	726	10076.25	10076.25	13.88		
Total	768	14895.72				

$$\text{Eq. 11: } BEV = 3.14 - 0.29 * \text{Bat Azimuth Velocity}_{time} + A * \mu + B * LOC + 1.20 * PS + C * LOC * \text{Bat Azimuth Velocity}_{time}$$

In Eq. 11, the ranges for the coefficients were A: [-4.34 to 5.04], B: [HIGH IN = -4.94, HIGH OUT = -0.39, LOW IN = 1.21, LOW OUT = 2.84], and C: [HIGH IN = -0.30, HIGH OUT = 0.04, LOW IN = 0.03, LOW OUT = 0.24]. In practicality, increases in BEV were associated with earlier (relative to the time of BC) peak bat



azimuth velocity for all pitch locations, though to different extents. According to the model, the difference between the minimum and maximum measured values of the time of peak bat azimuth velocity ( $-26.67$  ms to  $+13.33$  ms, respectively) would leave to a BEV difference of  $-23.72$  m/s for HIGH IN,  $-11.80$  m/s for MIDDLE,  $-10.49$  m/s for LOW IN,  $-10.12$  m/s for HIGH OUT, and  $-2.12$  m/s for LOW OUT. Figure 31 below visualizes the model-estimated BEV based on the range of measured values of the time of peak bat azimuth velocity.

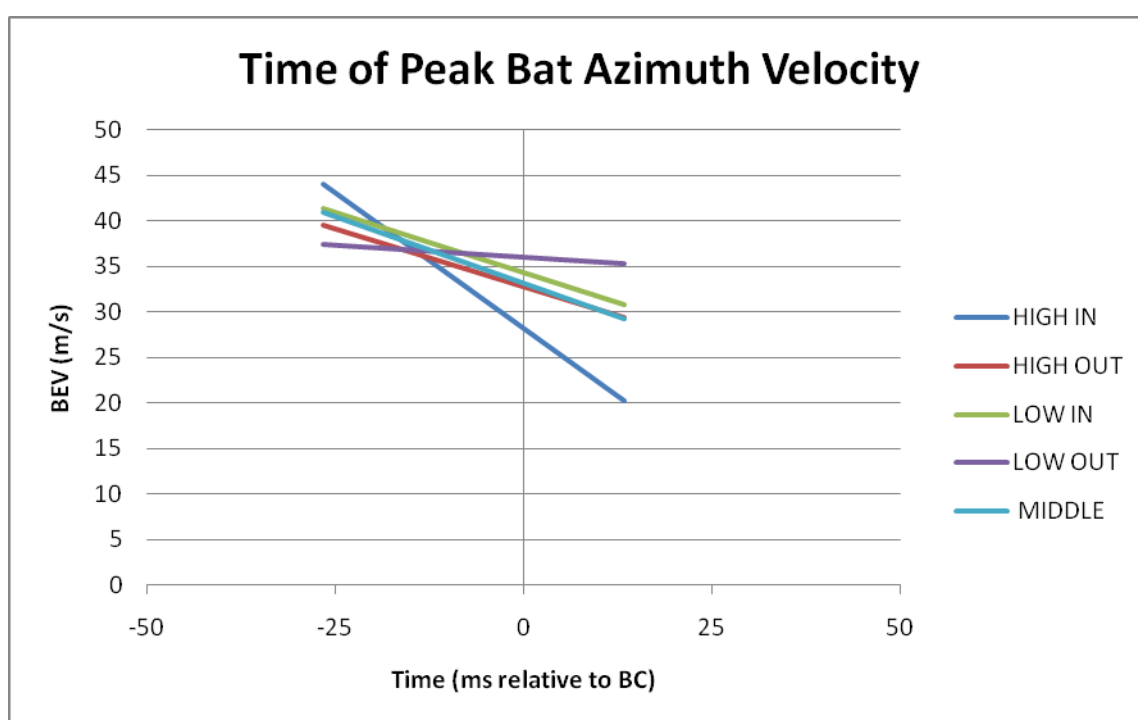

Figure 31. Model estimate of average BEV across values of time of peak bat azimuth velocity.

## 4.2.2.17 Peak lead knee extension velocity

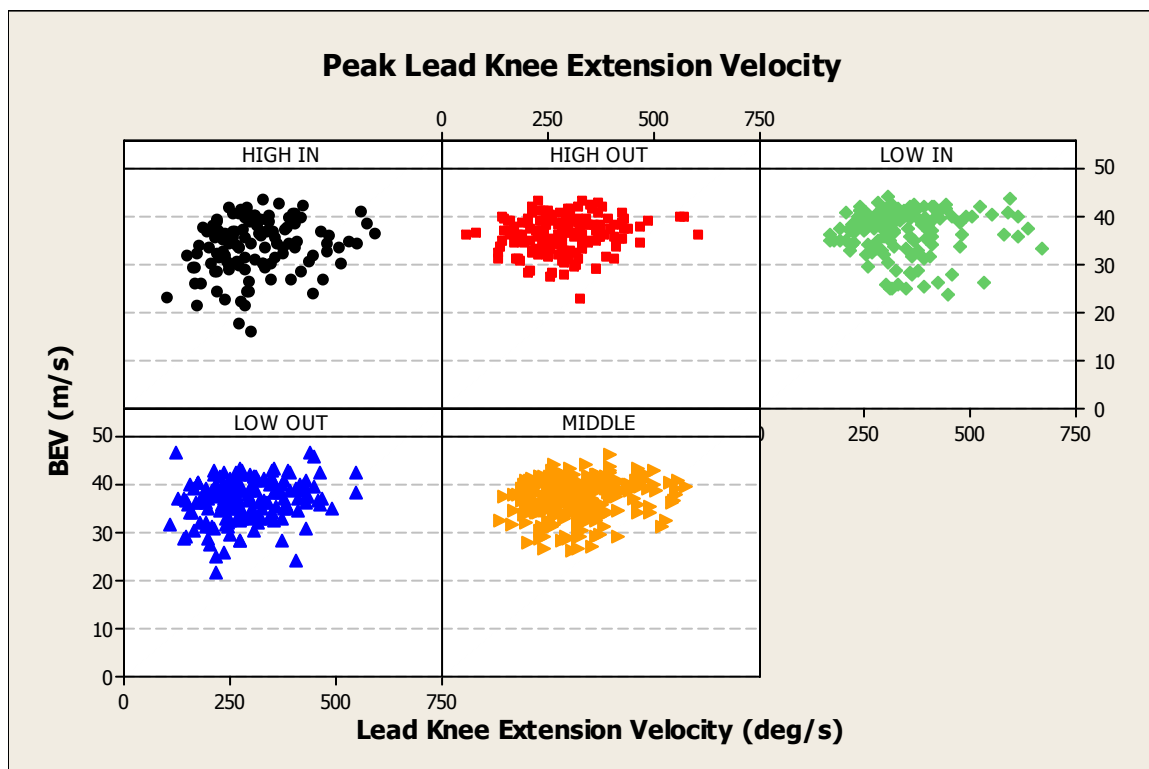

Figure 32. Peak lead knee extension velocity across BEV (raw data)

Table 22. Analysis of variance for peak lead knee extension velocity

Source	DF	Seq SS	Adj SS	Adj MS	F	P
Lead Knee Speed	1	335.94	59.41	59.41	3.81	0.051
Subject	32	2602.44	763.46	23.86	1.53	0.032
Location	4	970.46	892.42	223.11	14.30	0.000
PS	1	124.42	133.79	133.79	8.57	0.004
Subject*PS	32	742.44	742.44	23.20	1.49	0.042
Error	792	12360.35	12360.35	15.61		
Total	862	17136.06				

As seen in Table 22, there was not a significant relationship between the peak lead knee extension velocity and BEV. Thus no equation or graph of estimated BEV versus peak lead knee extension velocity was developed.

## 4.2.2.18 Peak pelvis rotation velocity

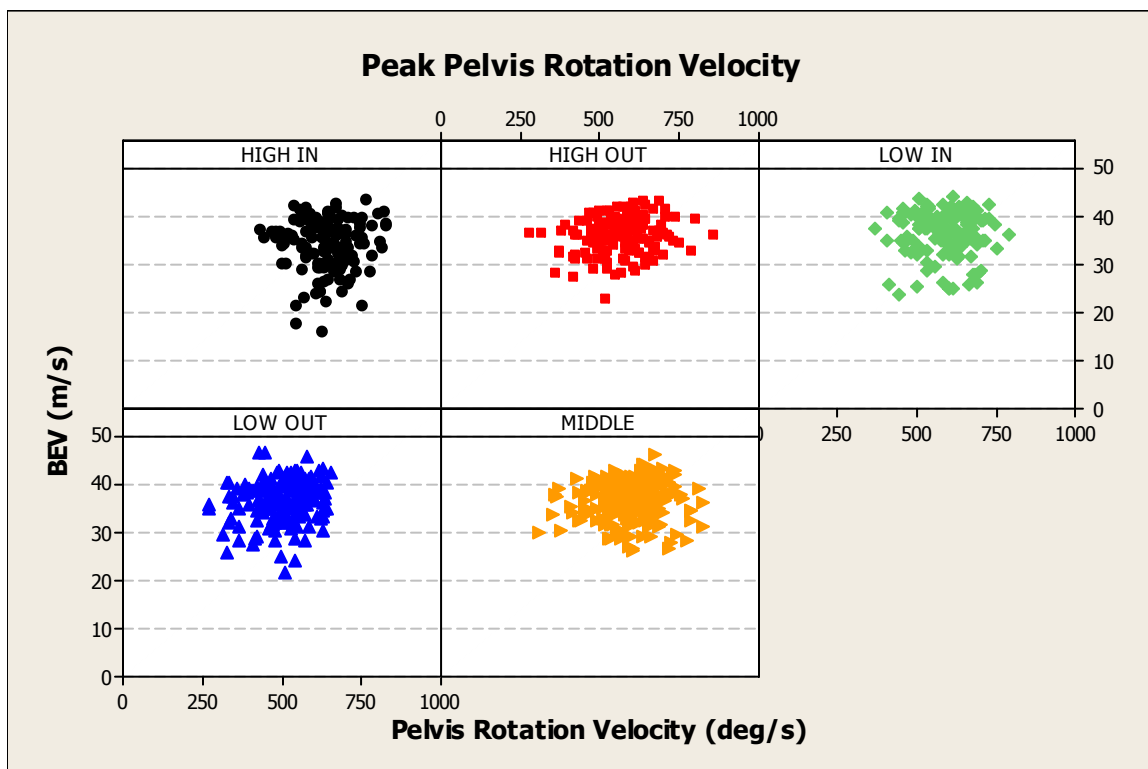

Figure 33. Peak pelvis rotation velocity across BEV (raw data)

Table 23. Analysis of variance for peak pelvis rotation velocity

Source	DF	Seq SS	Adj SS	Adj MS	F	P
Pelvis speed	1	61.71	3.41	3.41	0.23	0.635
Subject	32	2742.43	846.32	26.45	1.75	0.007
Location	4	912.71	784.24	196.06	12.98	0.000
PS	1	165.54	134.62	134.62	8.91	0.003
Subject*Pelvis speed	32	828.03	810.85	25.34	1.68	0.011
Subject*PS	32	759.37	759.37	23.73	1.57	0.024
Error	765	11553.64	11553.64	15.10		
Total	867	17023.41				

$$\text{Eq. 12: } BEV = 12.31 + 1.54e^{-3} * \text{Pelvis Rotation Velocity} + A * \mu + B * LOC + 0.90 * PS + C * \mu * \text{Pelvis Rotation Velocity} + D * \mu * PS$$

In Eq. 12, the ranges for the coefficients were A: [-108.46 to 101.94], B: [HIGH IN = -1.84, HIGH OUT = 0.23, LOW IN = 0.02, LOW OUT = 0.26], C: [-0.05 to 0.05], and D: [-3.96 to 4.03]. In practicality, there was no significant group-wise association

between peak pelvis rotation velocity and BEV. According to the model, the difference between the minimum and maximum measured values of pelvis rotation velocity (273.16°/s and 861.38°/s, respectively) would lead to a BEV difference of +0.91 m/s. Figure 34 below visualizes the model-estimated BEV based on the range of measured values of peak pelvis rotation velocity.

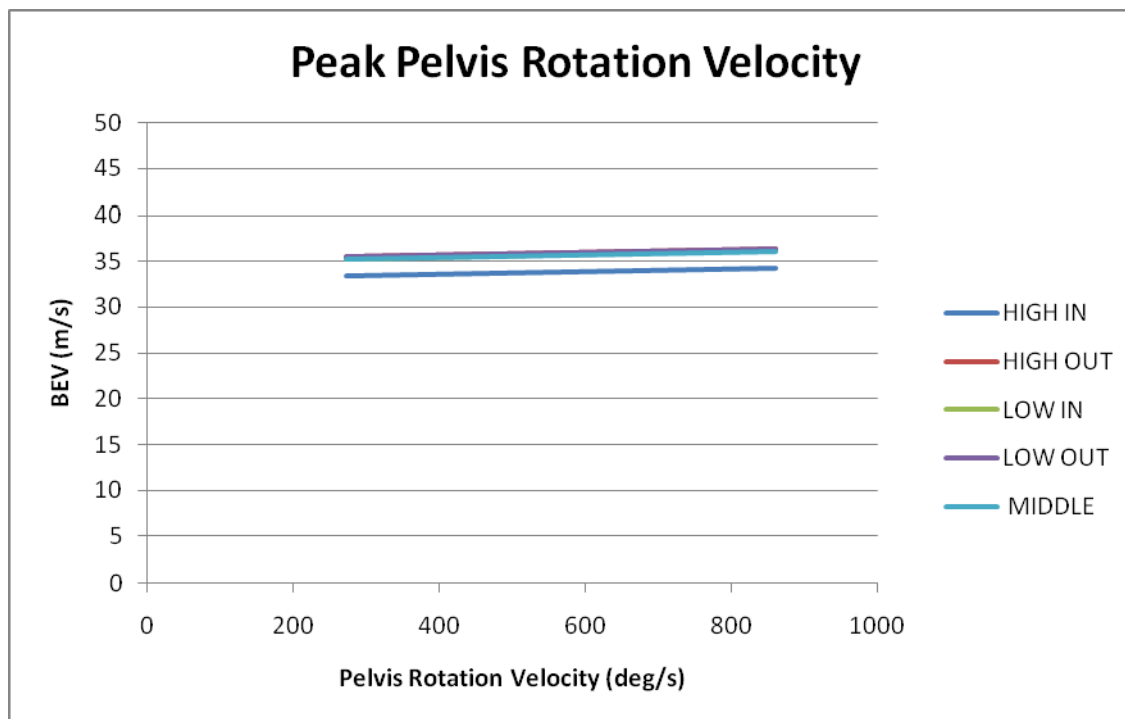

Figure 34. Model estimate of average BEV across values of peak pelvis rotation velocity.

## 4.2.2.19 Peak upper trunk rotation velocity

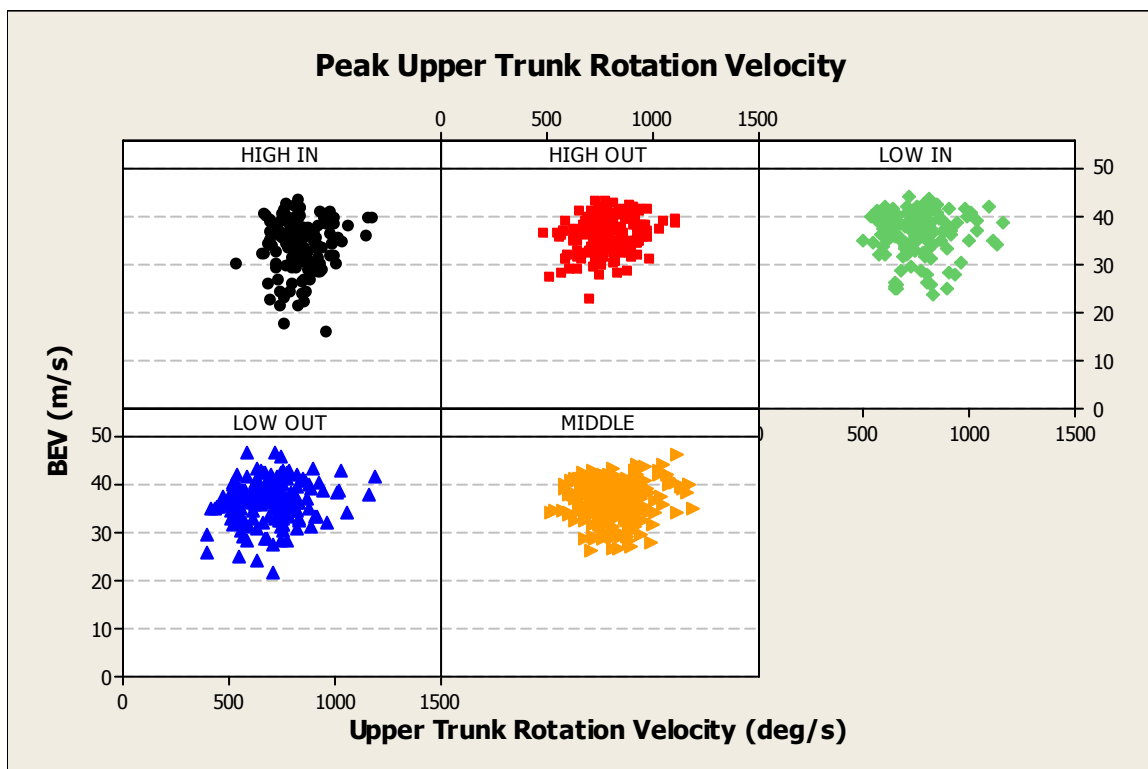

Figure 35. Peak upper trunk rotation velocity across BEV (raw data)

Table 24. Analysis of variance for peak upper trunk rotation velocity

Source	DF	Seq SS	Adj SS	Adj MS	F	P
Upper Trunk speed	1	117.39	8.98	8.98	0.57	0.449
Subject	32	2753.92	798.54	24.95	1.60	0.020
Location	4	947.85	887.46	221.87	14.19	0.000
PS	1	133.97	132.83	132.83	8.50	0.004
Subject*PS	32	775.56	775.56	24.24	1.55	0.028
Error	795	12427.48	12427.48	15.63		
Total	865	17156.17				

As seen in Table 24, there was not a significant relationship between the peak upper trunk velocity and BEV. Thus no equation or graph of estimated BEV versus peak upper trunk velocity was developed.

## 4.2.2.20 Peak lead shoulder azimuth velocity

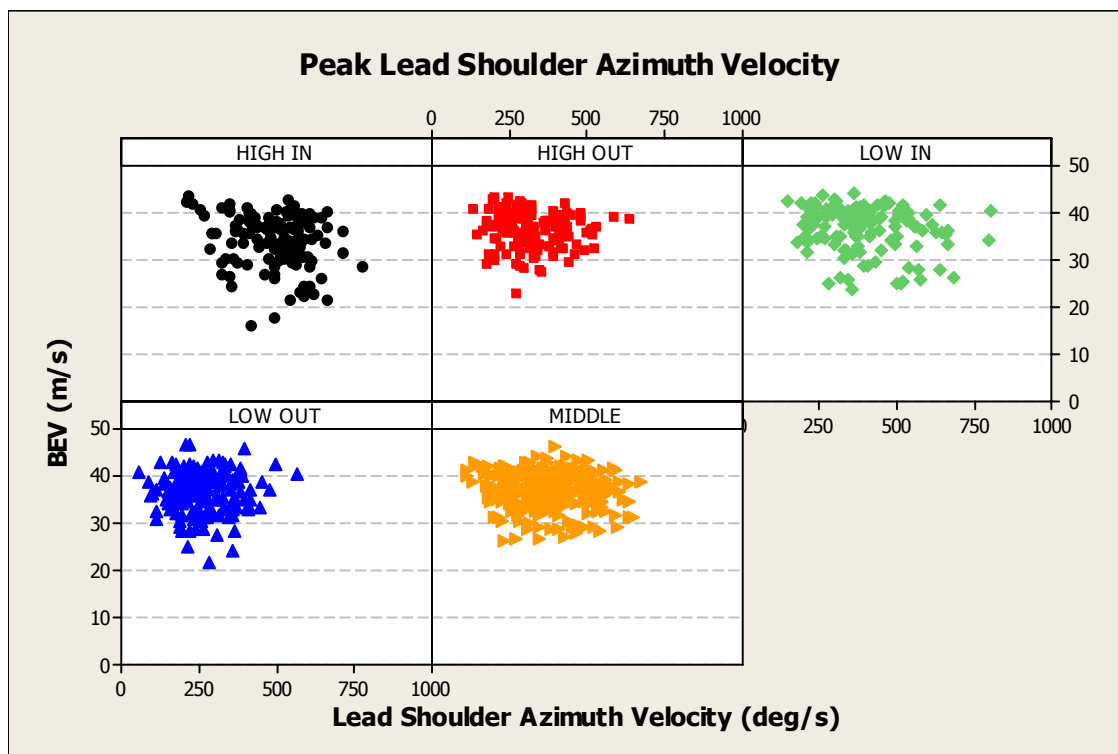

Figure 36. Peak lead shoulder azimuth velocity across BEV (raw data)

Table 25. Analysis of variance for peak lead shoulder azimuth velocity

Source	DF	Seq SS	Adj SS	Adj MS	F	P
Lead Shoulder Azim speed	1	517.84	68.59	68.59	4.67	0.031
Subject	31	2727.40	712.63	22.99	1.57	0.027
Location	4	680.51	198.35	49.59	3.38	0.009
PS	1	145.32	10.34	10.34	0.70	0.401
Subject*Lead Shoulder Azim speed	31	895.13	970.76	31.31	2.13	0.000
Location*Lead Shoulder Azim speed	4	282.66	236.98	59.24	4.04	0.003
PS*Lead Shoulder Azim speed	1	44.15	62.11	62.11	4.23	0.040
Subject*PS	31	699.84	699.84	22.58	1.54	0.032
Error	733	10757.32	10757.32	14.68		
Total	837	16750.18				

$$Eq. 13: BEV = 57.36 - 0.13 * Lead\ Shoulder\ Azimuth\ Velocity + A * \mu + B * LOC - 0.77 * PS + C * \mu * Lead\ Shoulder\ Azimuth\ Velocity + D * LOC * Lead\ Shoulder\ Azimuth\ Velocity + 4.98e-3 * PS * Lead\ Shoulder\ Azimuth\ Velocity + E * \mu * PS$$

In Eq. 13, the ranges for the coefficients were A: [-112.79 to 120.46], B: [HIGH IN = 3.20, HIGH OUT = -1.36, LOW IN = 1.10, LOW OUT = -0.77], C: [-0.02 to 0.02], D: [HIGH IN = -0.01, HIGH OUT = 2.73e-3, LOW IN = -3.38e-3, LOW OUT =

0.01], and E: [-4.57 to 4.16]. Increases in BEV were associated with changes in peak lead shoulder azimuth velocity, but the effects varied based both on LOC and PS.

According to the model, the difference between the minimum and maximum measured values of lead shoulder azimuth velocity (59.11°/s and 806.01, respectively) at low PS (23.2 m/s) would lead to a BEV difference of -19.36 m/s for HIGH IN, -14.08 m/s for LOW IN, -11.56 m/s for MIDDLE, -9.52 m/s for HIGH OUT, and -4.73 m/s for LOW OUT. At medium PS (25.0 m/s), the effect on BEV would be -12.67 m/s for HIGH IN, -7.39 m/s for LOW IN, -4.87 m/s for MIDDLE, -2.83 m/s for HIGH OUT, and +1.97 m/s for LOW OUT. At high PS (26.8 m/s), the effect on BEV would be -5.98 m/s for HIGH IN, -0.70 m/s for LOW IN, +1.83 for MIDDLE, +3.86 m/s for HIGH OUT, and +8.66 m/s for LOW OUT. Figures 37-39 below visualize the model-estimated BEV based on the range of measured values of peak lead shoulder azimuth velocity for low (i.e. mean - 3 SD), medium (i.e. mean), and high PS (i.e. mean + 3 SD).

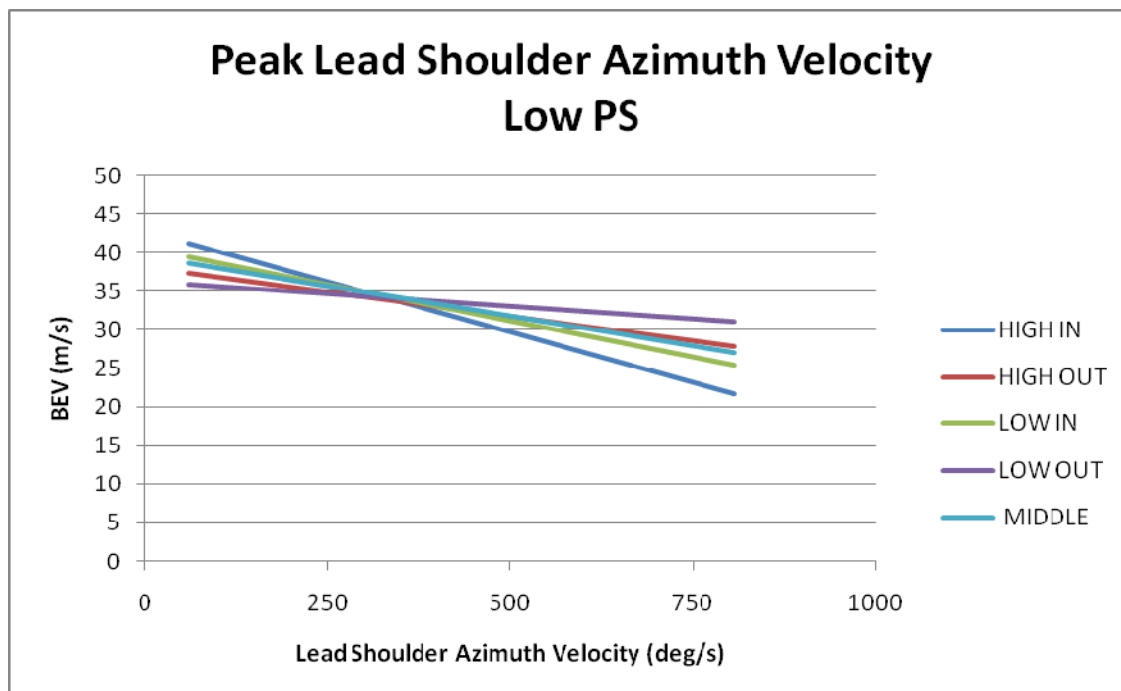

Figure 37. Model estimate of average BEV across values of peak lead shoulder azimuth velocity at low PS.

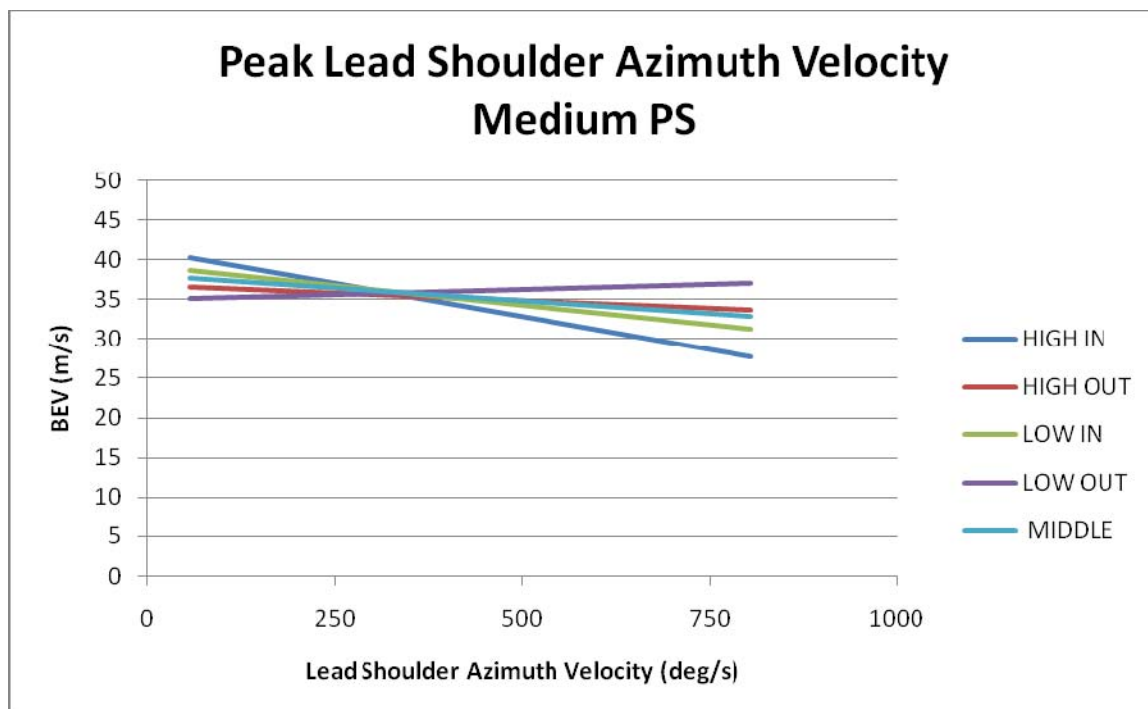

Figure 38. Model estimate of average BEV across values of peak lead shoulder azimuth velocity at medium PS.

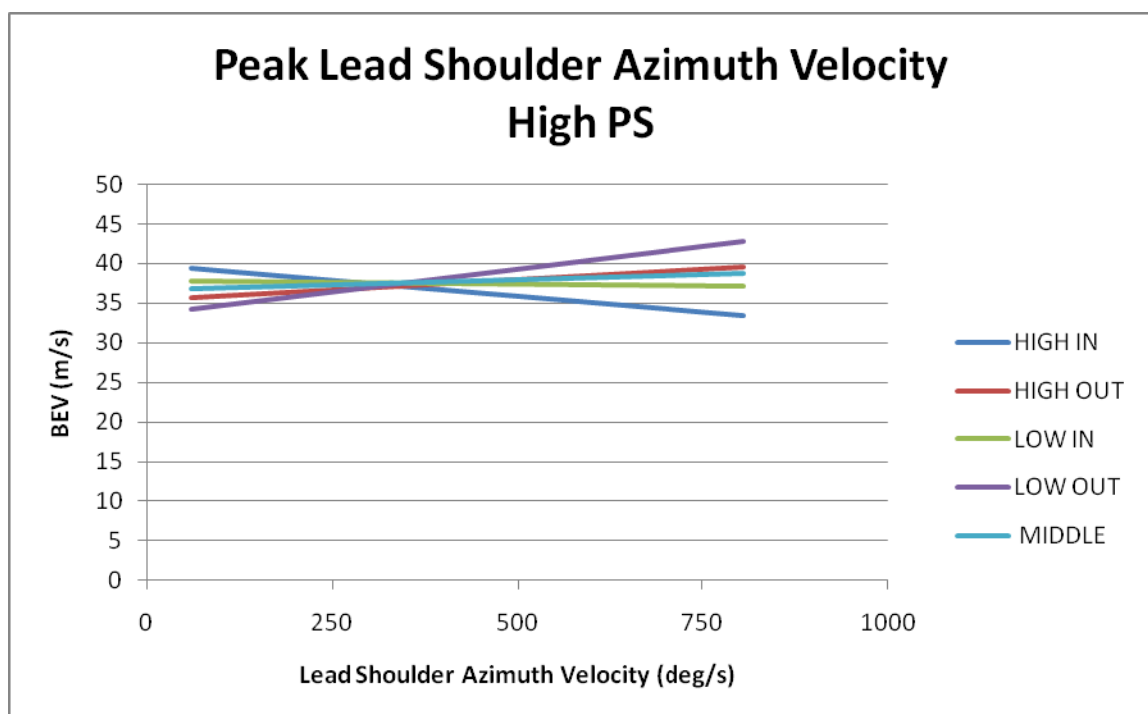

Figure 39. Model estimate of average BEV across values of peak lead shoulder azimuth velocity at high PS.



## 4.2.2.21 Peak trail elbow extension velocity

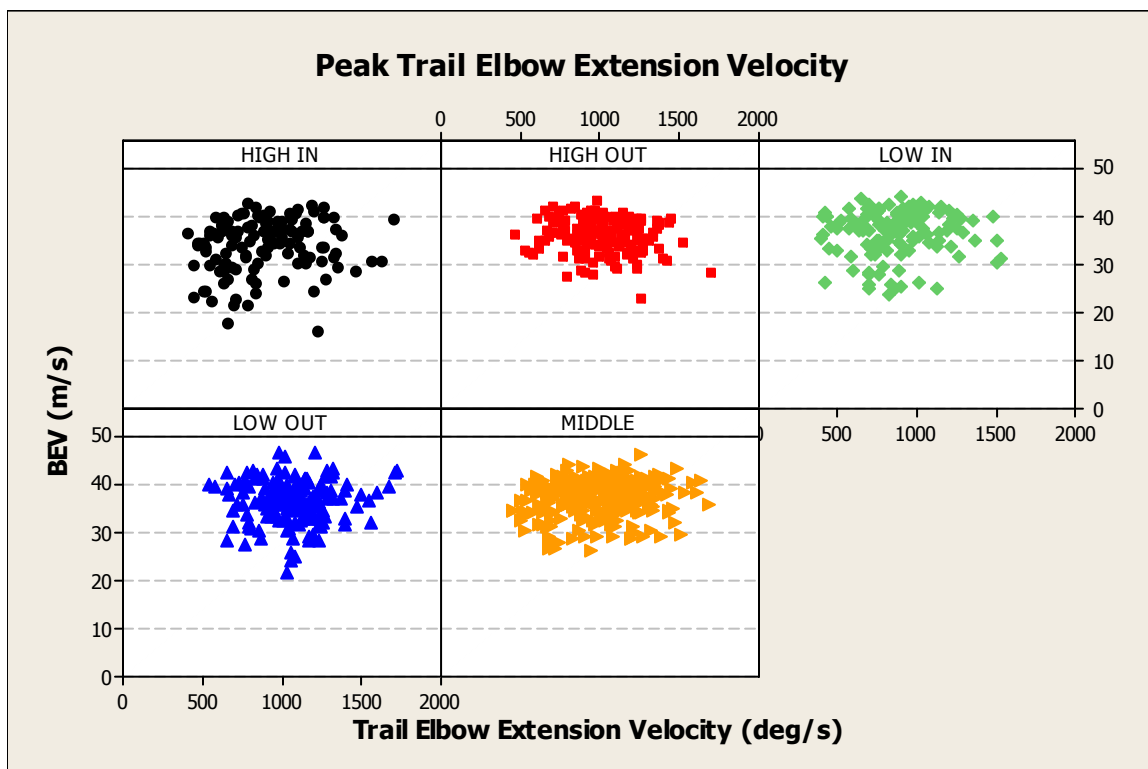

Figure 40. Peak trail elbow extension velocity across BEV (raw data)

Table 26. Analysis of variance for peak trail elbow extension velocity

Source	DF	Seq SS	Adj SS	Adj MS	F	P
Trail Elbow Ext speed	1	111.26	9.99	9.99	0.63	0.427
Subject	32	2421.38	767.09	23.97	1.52	0.034
Location	4	930.30	812.08	203.02	12.85	0.000
PS	1	192.64	57.27	57.27	3.62	0.057
Subject*PS	32	747.35	747.35	23.35	1.48	0.044
Error	769	12149.34	12149.34	15.80		
Total	839	16552.26				

As seen in Table 26, there was not a significant relationship between the peak trail elbow extension velocity and BEV. Thus no equation or graph of estimated BEV versus peak trail elbow extension velocity was developed.

## 4.2.2.22 Peak bat azimuth velocity

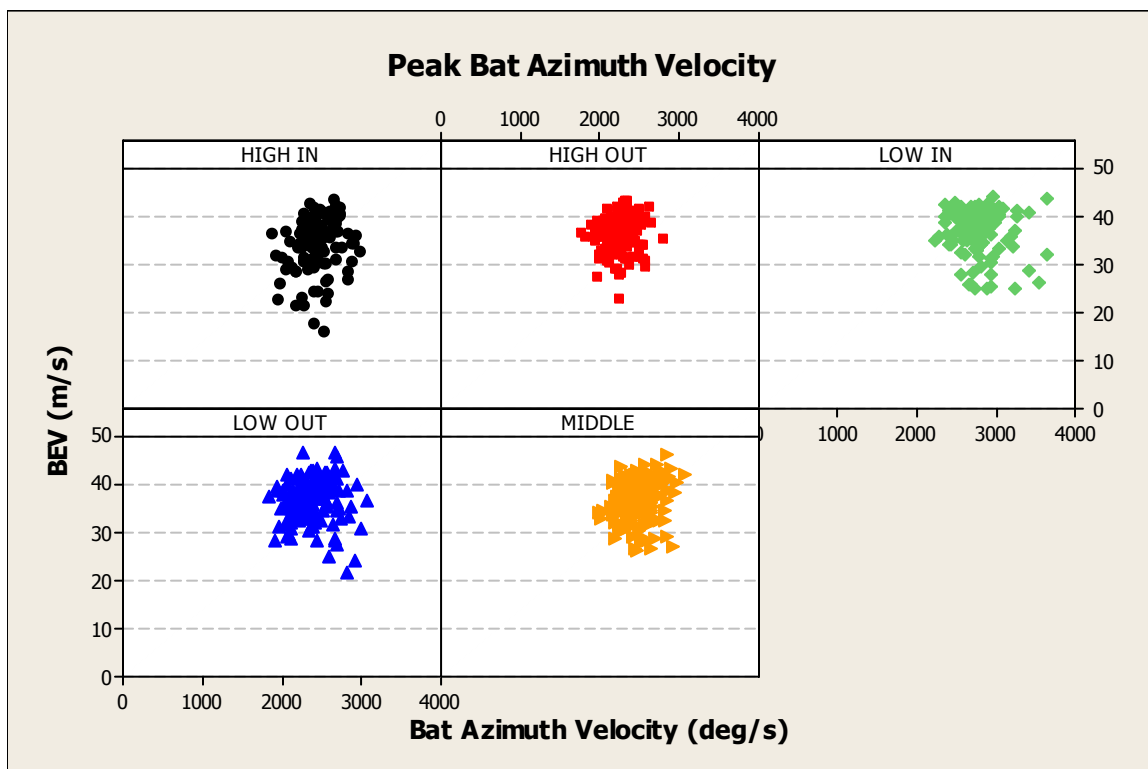

Figure 41. Peak bat azimuth velocity across BEV (raw data)

Table 27. Analysis of variance for peak bat azimuth velocity

Source	DF	Seq SS	Adj SS	Adj MS	F	P
Bat Azimuth speed	1	119.42	5.72	5.72	0.37	0.545
Subject	32	2233.01	2409.59	75.30	4.82	0.000
Location	4	786.17	290.41	72.60	4.65	0.001
PS	1	143.05	165.94	165.94	10.62	0.001
Location*Bat Azimuth speed	4	269.06	269.06	67.26	4.30	0.002
Error	726	11345.01	11345.01	15.63		
Total	768	14895.72				

$$\text{Eq. 14: } BEV = 14.67 + 5.04e-4 * \text{Bat Azimuth Velocity} + A * \mu + B * LOC + 0.83 * PS + C * LOC * \text{Bat Azimuth Velocity}$$

In Eq. 14, the ranges for the coefficients were A: [-3.94 to 3.94], B: [HIGH IN = -9.91, HIGH OUT = -4.05, LOW IN = 11.34, LOW OUT = 5.62], and C: [HIGH IN = 3.22e-3, HIGH OUT = 1.73e-3, LOW IN = -4.18e-3, LOW OUT = -2.38e-3]. In practicality, increases in BEV were associated with decreased (i.e. slower) peak bat

azimuth velocity for LOW IN and LOW OUT and increased (i.e. faster) peak bat azimuth velocity for HIGH IN and HIGH OUT. According to the model, the difference between the minimum and maximum measured values of bat azimuth velocity (1768.20°/s and 3643.70°/s, respectively) would lead to a BEV difference of  $-6.89$  m/s for LOW IN,  $-3.51$  m/s for LOW OUT,  $+0.95$  m/s for MIDDLE,  $+4.18$  m/s for HIGH OUT, and  $+6.99$  m/s for HIGH IN. Figure 42 below visualizes the model-estimated BEV based on the range of measured values of peak bat azimuth velocity.

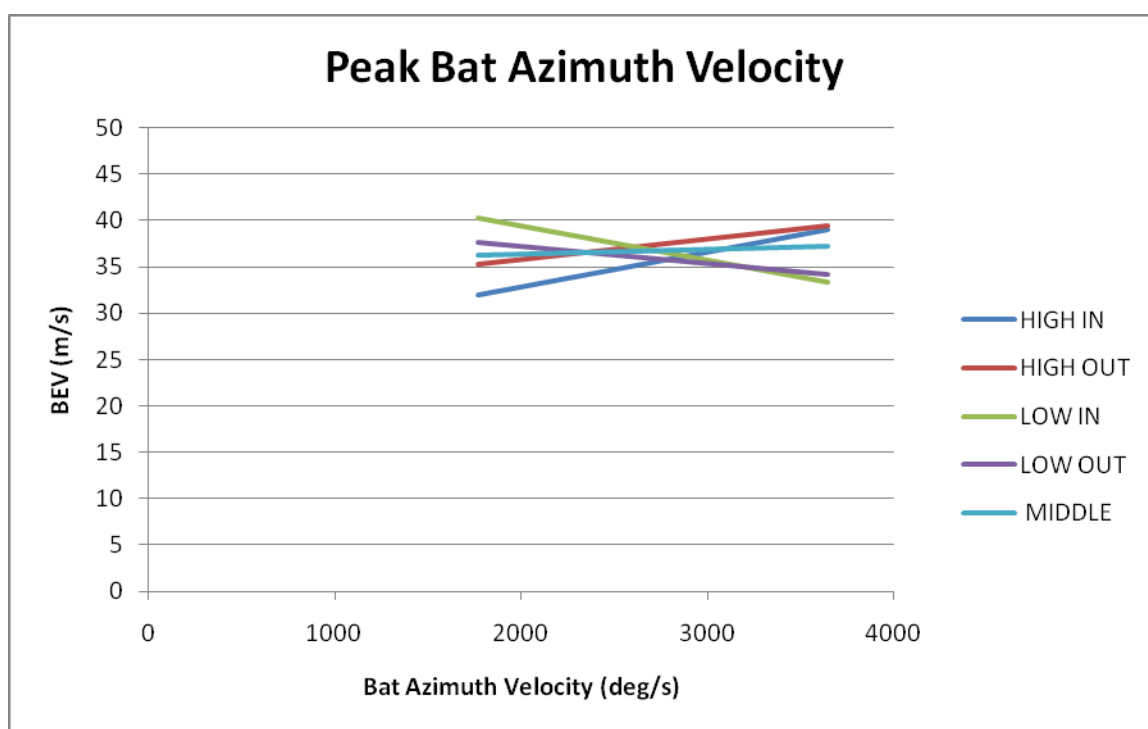

Figure 42. Model estimate of average BEV across values of peak bat azimuth velocity.

## 4.2.2.23 Time of peak trail foot GRFx

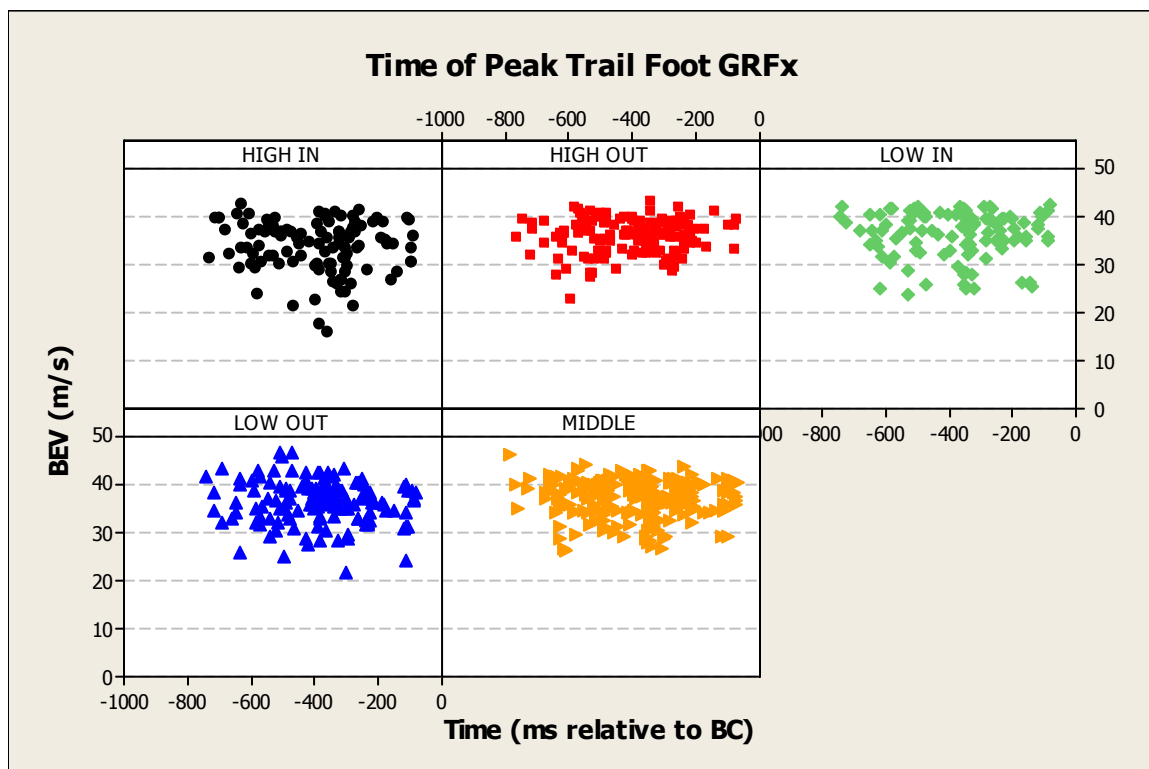

Figure 43. Time of peak trail foot GRFx across BEV (raw data)

Table 28. Analysis of variance for time of peak trail foot GRFx

Source	DF	Seq SS	Adj SS	Adj MS	F	P
TF GRFx time	1	17.10	12.28	12.28	0.76	0.384
Subject	28	2082.08	2208.02	78.86	4.87	0.000
Location	4	782.84	705.36	176.34	10.88	0.000
PS	1	153.51	153.51	153.51	9.47	0.002
Error	702	11374.80	11374.80	16.20		
Total	736	14410.33				

As seen in Table 28, there was not a significant relationship between time of peak trail foot GRFx and BEV. Thus no equation or graph of estimated BEV versus time of peak trail foot GRFx was developed.

## 4.2.2.24 Time of peak trail foot GRFy

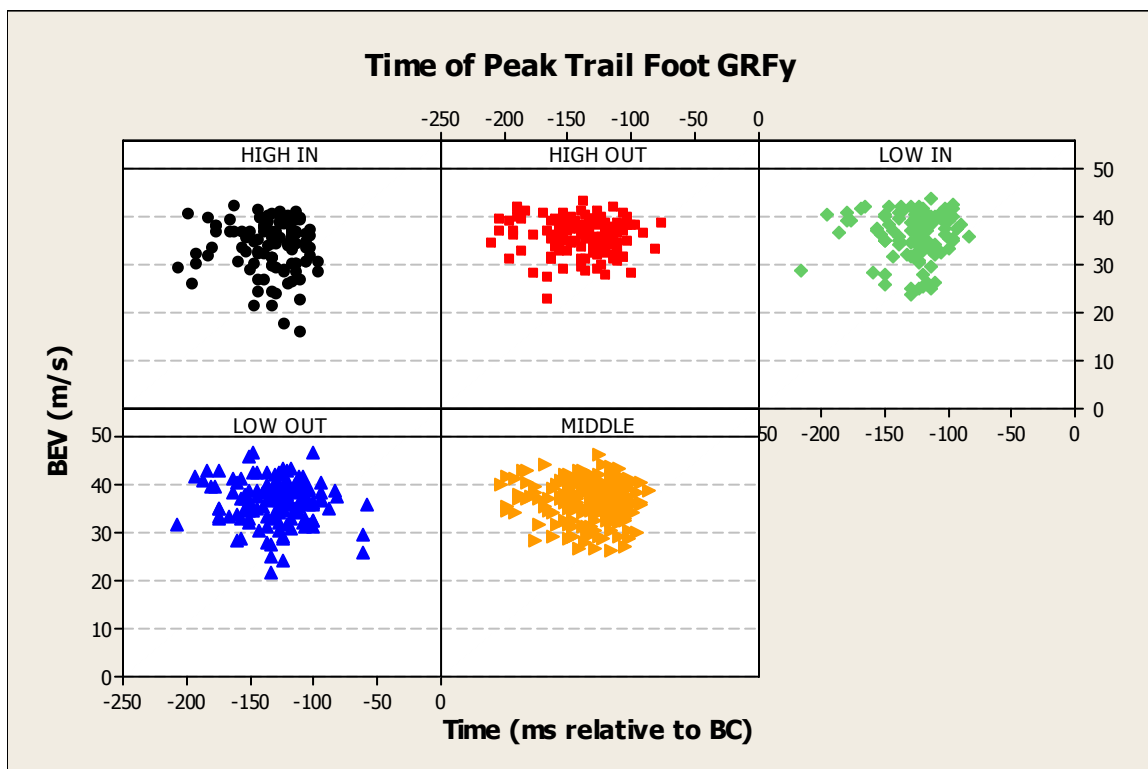

Figure 44. Time of peak trail foot GRFy across BEV (raw data)

Table 29. Analysis of variance for time of peak trail foot GRFy

Source	DF	Seq SS	Adj SS	Adj MS	F	P
TF GRFy time	1	13.64	15.76	15.76	0.97	0.325
Subject	28	2193.27	2314.27	82.65	5.08	0.000
Location	4	784.89	704.58	176.14	10.83	0.000
PS	1	154.11	154.11	154.11	9.47	0.002
Error	699	11369.26	11369.26	16.27		
Total	733	14515.17				

As seen in Table 29, there was not a significant relationship between time of peak trail foot GRFy and BEV. Thus no equation or graph of estimated BEV versus time of peak trail foot GRFy was developed.

## 4.2.2.25 Time of peak trail foot GRFz

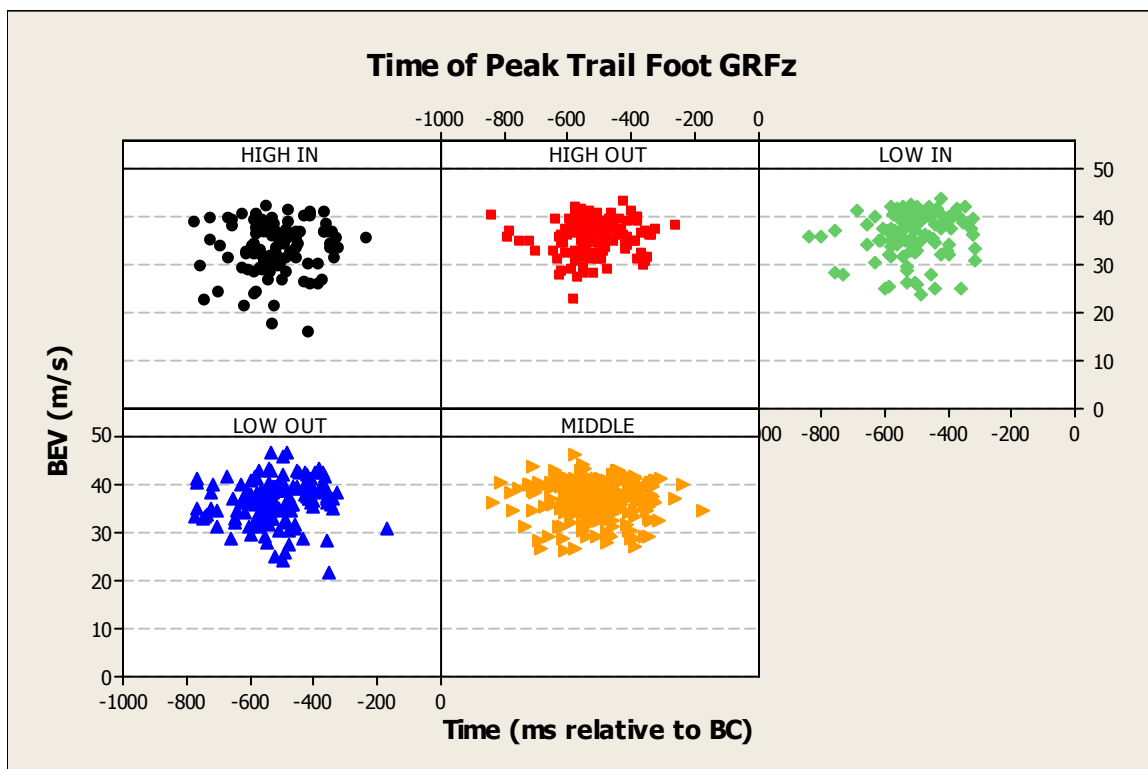

Figure 45. Time of peak trail foot GRFz across BEV (raw data)

Table 30. Analysis of variance of time of peak trail foot GRFz

Source	DF	Seq SS	Adj SS	Adj MS	F	P
TF GRFz time	1	65.66	13.96	13.96	0.86	0.354
Subject	28	2043.88	2060.06	73.57	4.53	0.000
Location	4	801.07	718.08	179.52	11.04	0.000
PS	1	125.34	125.34	125.34	7.71	0.006
Error	696	11313.37	11313.37	16.25		
Total	730	14349.33				

As seen in Table 30, there was not a significant relationship between time of peak trail foot GRFz and BEV. Thus no equation or graph of estimated BEV versus time of peak trail foot GRFz was developed.

## 4.2.2.26 Time of peak lead foot GRFx

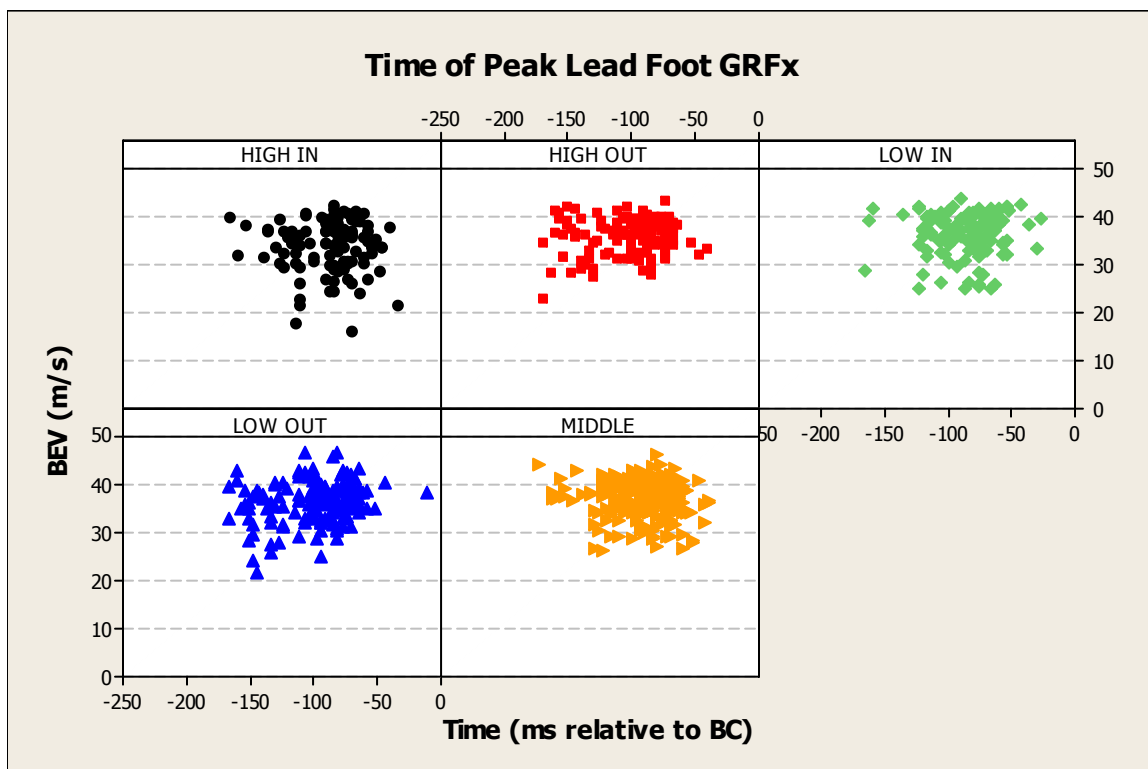

Figure 46. Time of peak lead foot GRFx across BEV (raw data)

Table 31. Analysis of variance for time of peak lead foot GRFx

Source	DF	Seq SS	Adj SS	Adj MS	F	P
LF GRFx time	1	21.86	113.24	113.24	7.07	0.008
Subject	28	2260.95	2387.72	85.28	5.32	0.000
Location	4	777.54	701.50	175.37	10.95	0.000
PS	1	135.96	135.96	135.96	8.49	0.004
Error	692	11082.41	11082.41	16.02		
Total	726	14278.73				

$$Eq. 15: BEV = 20.55 + 0.02 * Lead\ Foot\ GRFx_{time} + A * \mu + B * LOC + 0.70 * PS$$

In Eq. 15, the ranges for the coefficients were A: [-3.74 to 4.25] and B: [HIGH IN = -1.92, HIGH OUT = 0.20, LOW IN = -0.02, LOW OUT = 0.56]. In practicality, increases in BEV were associated with later (relative to the time of BC) peak lead foot GRFx for all pitch locations. According to the model, the difference between the

minimum and maximum measured values of the time of peak lead foot GRFx ( $-173.33$  ms and  $-10.00$  ms, respectively) would lead to a BEV difference of  $+3.62$  m/s. Figure 47 below visualizes the model-estimated BEV based on the range of measured values of the time of peak lead foot GRFx.

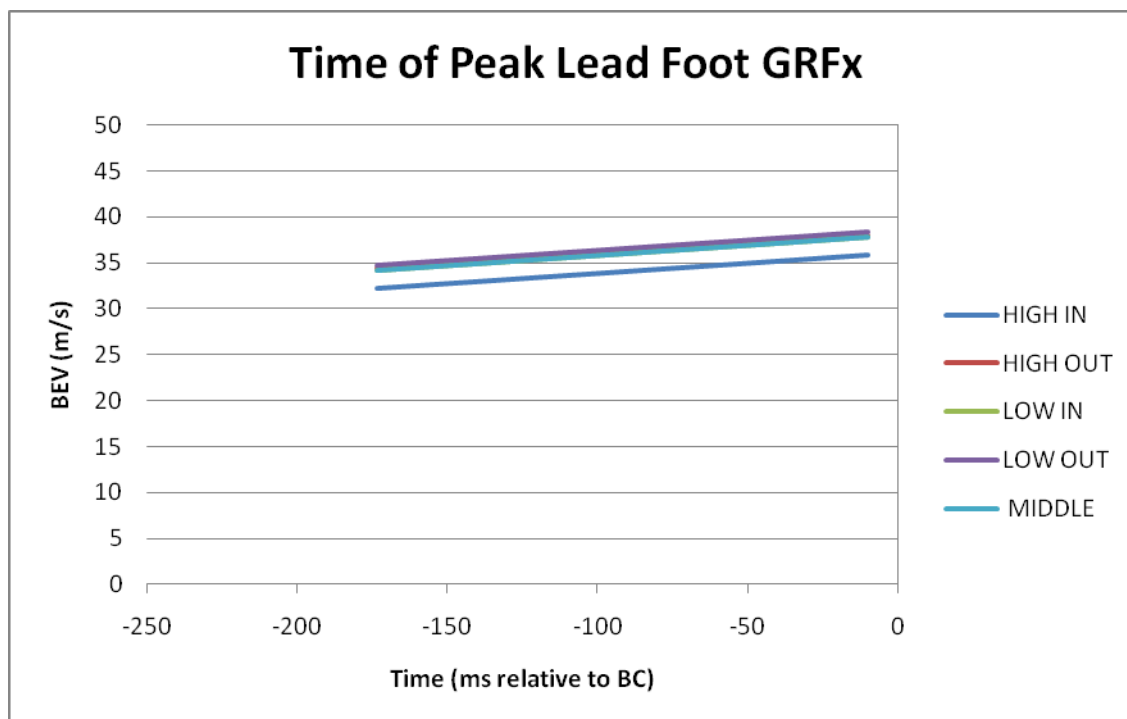

Figure 47. Model estimate of average BEV across values of time of peak lead foot GRFx.



## 4.2.2.27 Time of peak lead foot GRFy

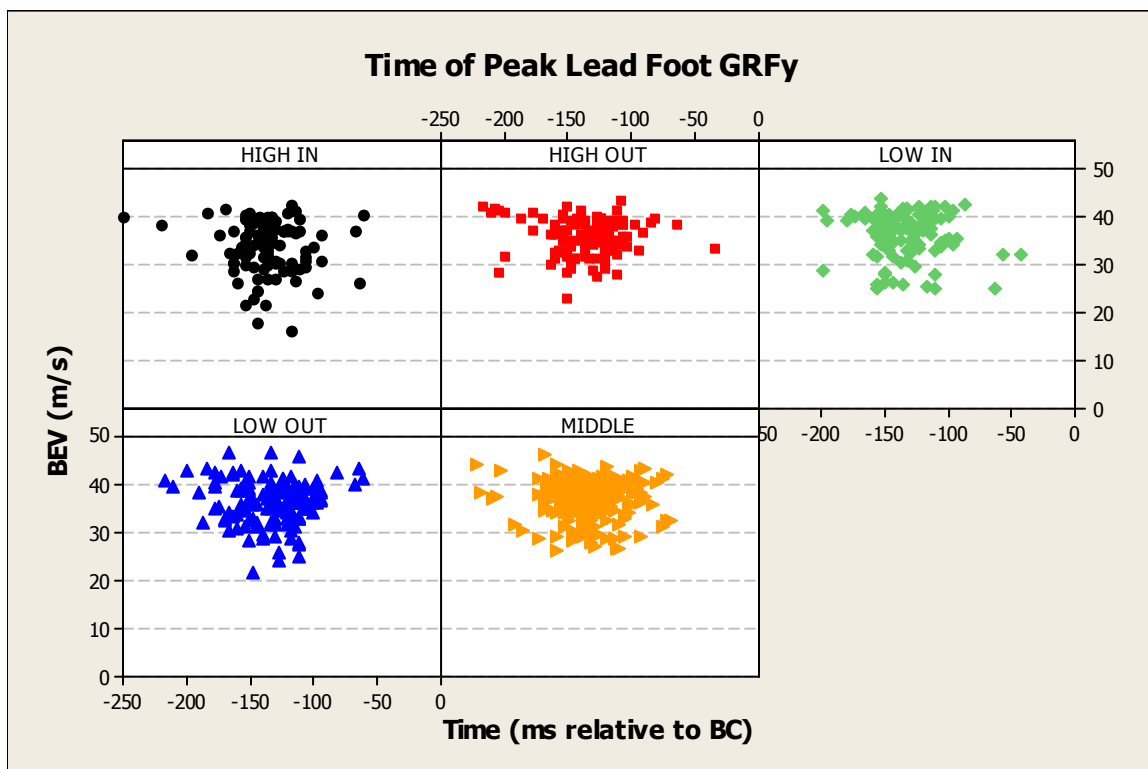

Figure 48. Time of peak lead foot GRFy across BEV (raw data)

Table 32. Analysis of variance for time of peak lead foot GRFy

Source	DF	Seq SS	Adj SS	Adj MS	F	P
LF GRFy time	1	41.31	48.54	48.54	2.94	0.087
Subject	27	2058.30	2126.58	78.76	4.78	0.000
Location	4	808.54	711.40	177.85	10.79	0.000
PS	1	160.07	160.07	160.07	9.71	0.002
Error	673	11096.48	11096.48	16.49		
Total	706	14164.70				

As seen in Table 32, there was not a significant relationship between time of peak lead foot GRFy and BEV. Thus no equation or graph of estimated BEV versus time of peak lead foot GRFy was developed.

## 4.2.2.28 Time of peak lead foot GRFz

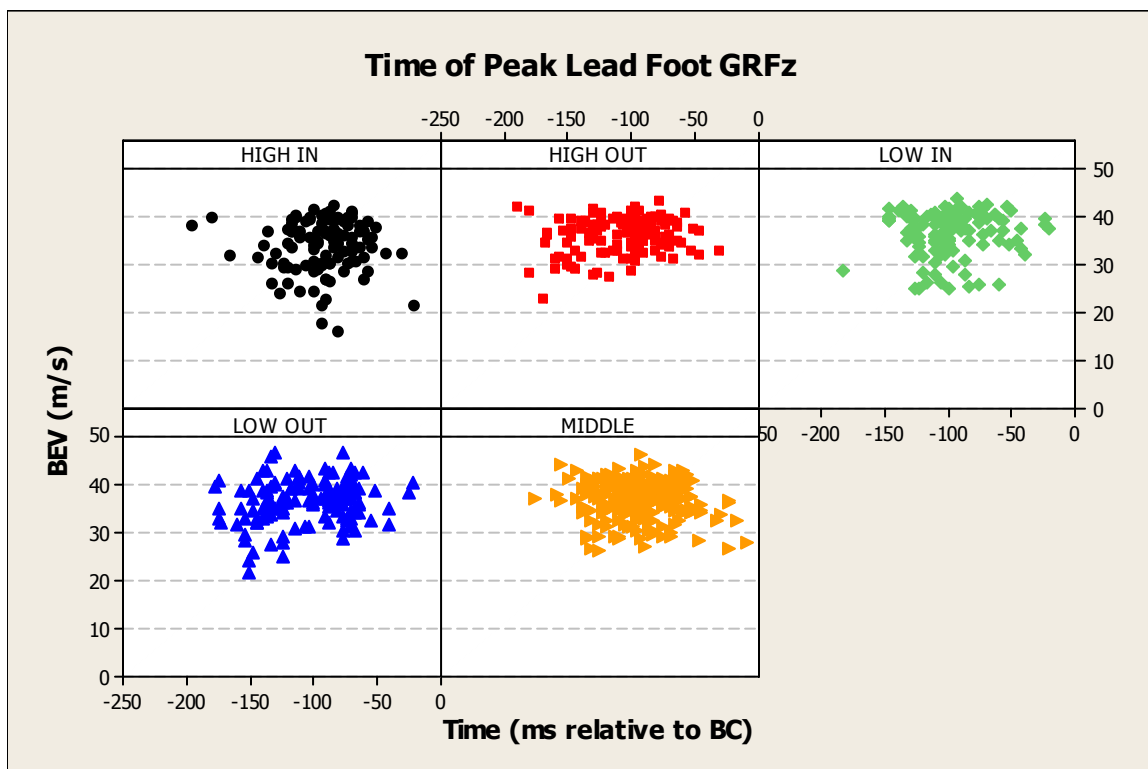

Figure 49. Time of peak lead foot GRFz across BEV (raw data)

Table 33. Analysis of variance for time of peak lead foot GRFz

Source	DF	Seq SS	Adj SS	Adj MS	F	P
LF GRFz time	1	46.19	128.79	128.79	8.02	0.005
Subject	28	2199.01	2324.99	83.04	5.17	0.000
Location	4	794.66	710.15	177.54	11.05	0.000
PS	1	171.78	171.78	171.78	10.69	0.001
Error	687	11035.19	11035.19	16.06		
Total	721	14246.82				

$$Eq. 16: BEV = 18.19 + 0.02 * Lead\ Foot\ GRFz_{time} + A * \mu + B * LOC + 0.79 * PS$$

In Eq. 16, the ranges for the coefficients were A: [-4.26 to 4.09] and B: [HIGH IN = -1.99, HIGH OUT = 0.21, LOW IN = 0.10, LOW OUT = 0.56]. In practicality, increases in BEV were associated with later (relative to the time of BC) peak lead foot GRFz. According to the model, the difference between the minimum and maximum measured values of the time of peak lead foot GRFz (-196.67 and -10.00 ms,

respectively) would lead to a BEV difference of +3.68 m/s. Figure 50 below visualizes the model-estimated BEV based on the range of measured values of the time of peak lead foot GRFz.

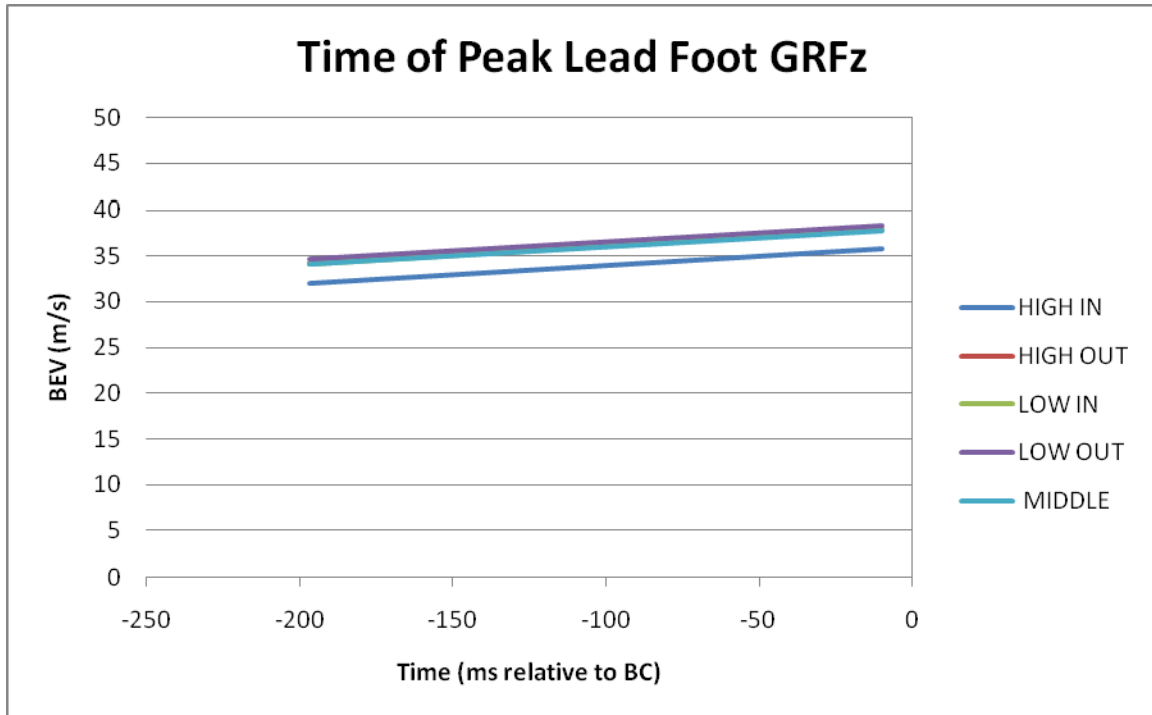

Figure 50. Model estimate of average BEV across values of time of peak lead foot GRFz.

## 4.2.2.29 Peak trail foot GRFx

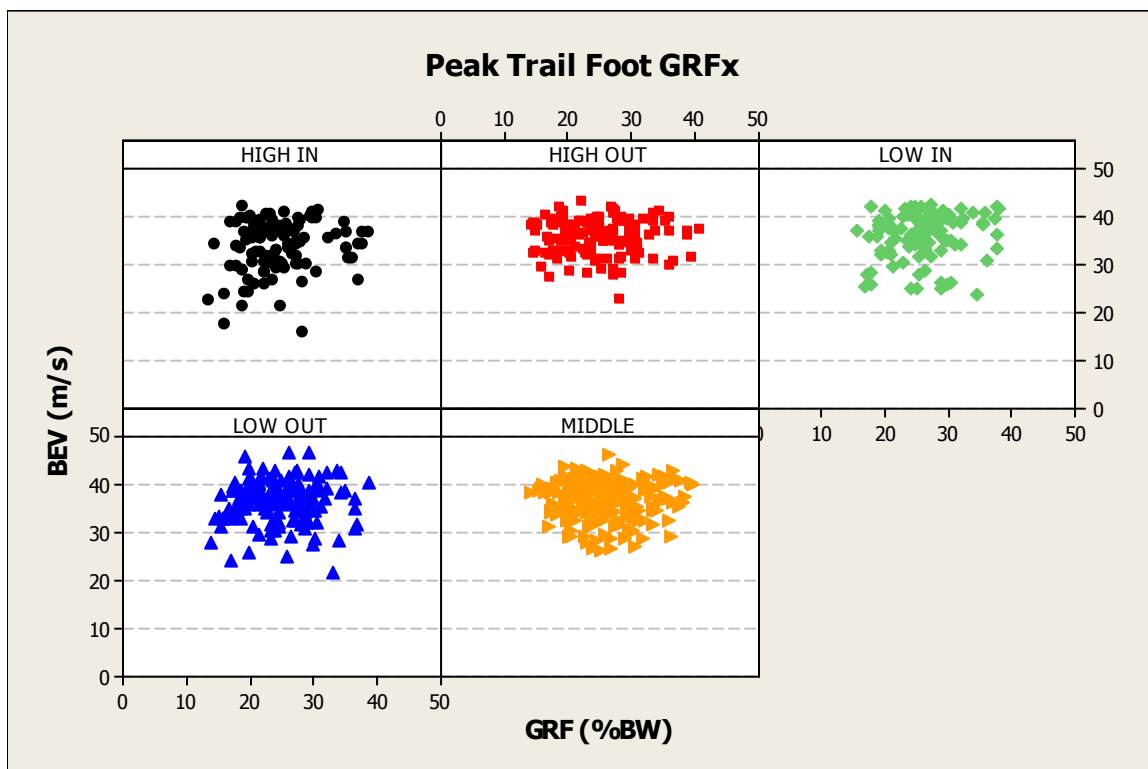

Figure 51. Peak trail foot GRFx across BEV (raw data)

Table 34. Analysis of variance for peak trail foot GRFx

Source	DF	Seq SS	Adj SS	Adj MS	F	P
TF GRFx	1	51.23	16.15	16.15	1.00	0.318
Subject	28	2087.50	2196.86	78.46	4.84	0.000
Location	4	759.68	686.64	171.66	10.60	0.000
PS	1	140.99	140.99	140.99	8.70	0.003
Error	702	11370.93	11370.93	16.20		
Total	736	14410.33				

As seen in Table 30, there was not a significant relationship between the peak trail foot GRFx and BEV. Thus no equation or graph of estimated BEV versus the peak trail foot GRFx was developed.

## 4.2.2.30 Peak trail foot GRFy

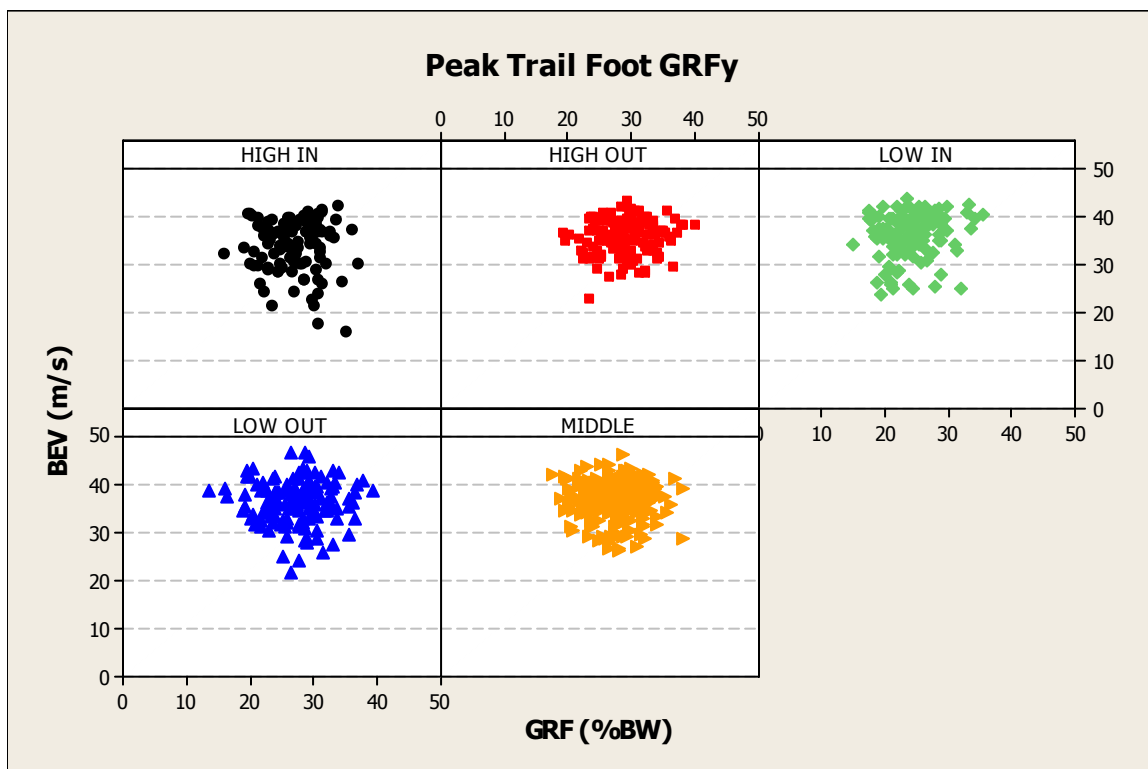

Figure 52. Peak trail foot GRFy across BEV (raw data)

Table 35. Analysis of variance for peak trail foot GRFy

Source	DF	Seq SS	Adj SS	Adj MS	F	P
TF GRFy	1	15.82	0.09	0.09	0.01	0.938
Subject	28	2204.77	613.50	21.91	1.41	0.081
Location	4	770.75	651.95	162.99	10.47	0.000
PS	1	144.42	180.75	180.75	11.61	0.001
Subject*TF GRFy	28	659.80	721.85	25.78	1.66	0.019
Subject*PS	28	709.42	709.42	25.34	1.63	0.023
Error	643	10010.18	10010.18	15.57		
Total	733	14515.17				

$$\text{Eq. 17: } BEV = 6.28 - 0.01 * \text{Trail Foot GRFy} + A * \mu + B * LOC + 1.15 * PS + C * \mu * \text{Trail Foot GRFy} + D * \mu * PS$$

In Eq. 17, the ranges for the coefficients were A: [-102.17 to 91.64], B: [HIGH IN = -1.92, HIGH OUT = 0.10, LOW IN = 0.28, LOW OUT = 0.31], C: [-1.07 to 0.95], and D: [-3.63 to 4.56]. In practicality, there was no significant group-wise association between peak trail foot GRFy and BEV. According to the model, the difference between

the minimum and maximum measured values of peak trail foot GRFy (13.59% BW and 40.22% BW) would lead to a BEV difference of  $-0.17$  m/s. Figure 53 below visualizes the model-estimated BEV based on the range of measured values of peak trail foot GRFy.

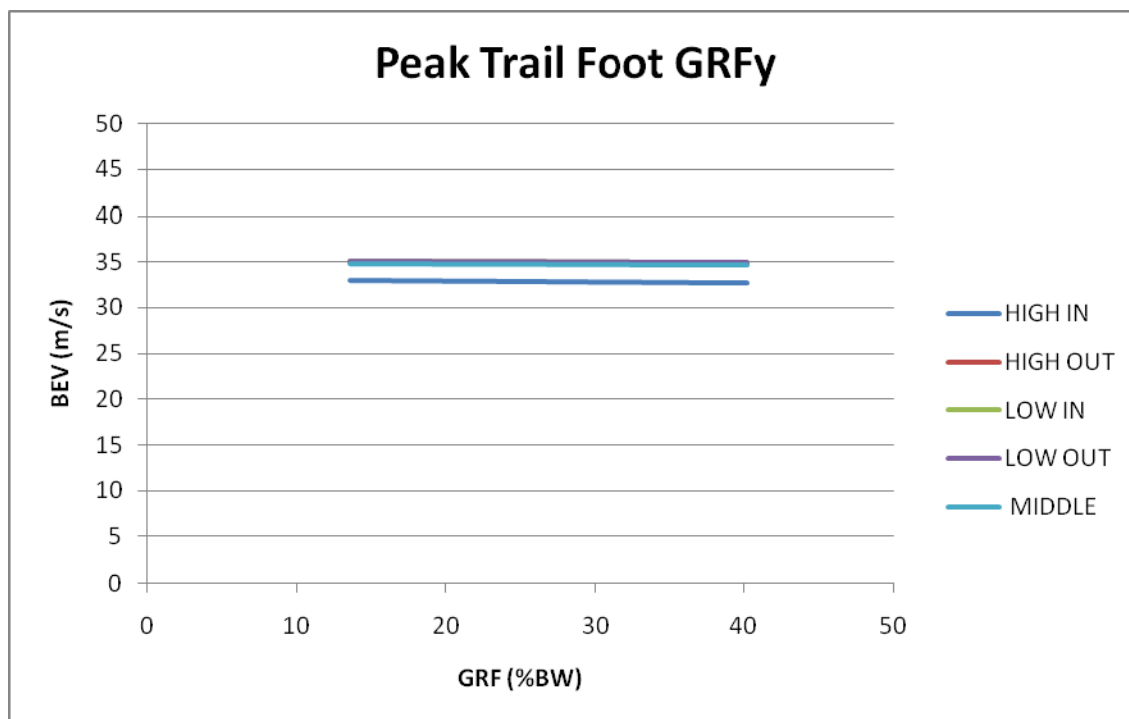

Figure 53. Model estimate of average BEV across value of peak trail foot GRFy.

## 4.2.2.31 Peak trail foot GRFz

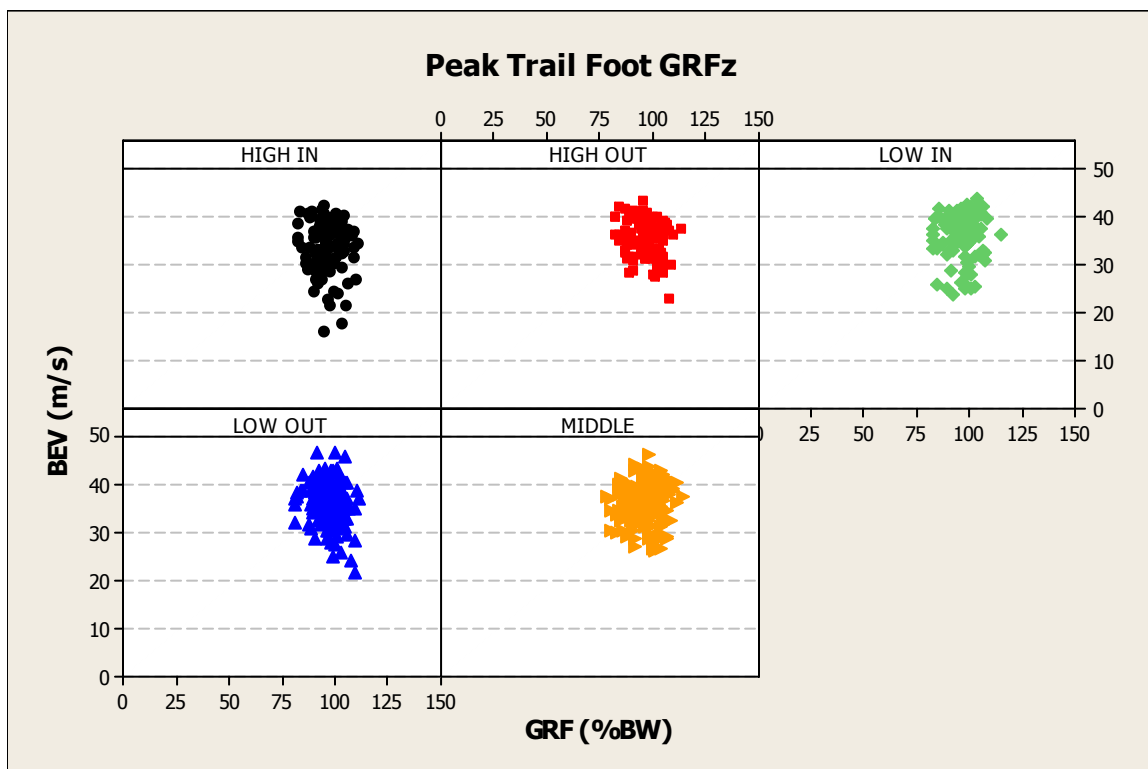

Figure 54. Peak trail foot GRFz across BEV (raw data)

Table 36. Analysis of variance for peak trail foot GRFz

Source	DF	Seq SS	Adj SS	Adj MS	F	P
TF GRFz	1	9.32	74.61	74.61	4.61	0.032
Subject	28	2123.42	2170.47	77.52	4.79	0.000
Location	4	813.73	717.39	179.35	11.09	0.000
PS	1	150.14	150.14	150.14	9.29	0.002
Error	696	11252.72	11252.72	16.17		
Total	730	14349.33				

$$Eq. 18: BEV = 31.56 - 0.15 * Trail Foot GRFz + A * \mu + B * LOC + 0.74 * PS$$

In Eq. 18, the ranges for the coefficients were A: [-5.78 to 2.60] and B: [HIGH IN = -1.84, HIGH OUT = -0.02, LOW IN = 0.15, LOW OUT = 0.41]. In practicality, increases in BEV were associated with decreased peak trail foot GRFz for all pitch locations. According to the model, the difference between the minimum and maximum

values of peak trail foot GRFz (78.13% BW and 114.69% BW, respectively) would lead to a BEV difference of  $-5.36$  m/s. Figure 55 below visualizes the model-estimated BEV based on the range of measured values of peak trail foot GRFz.

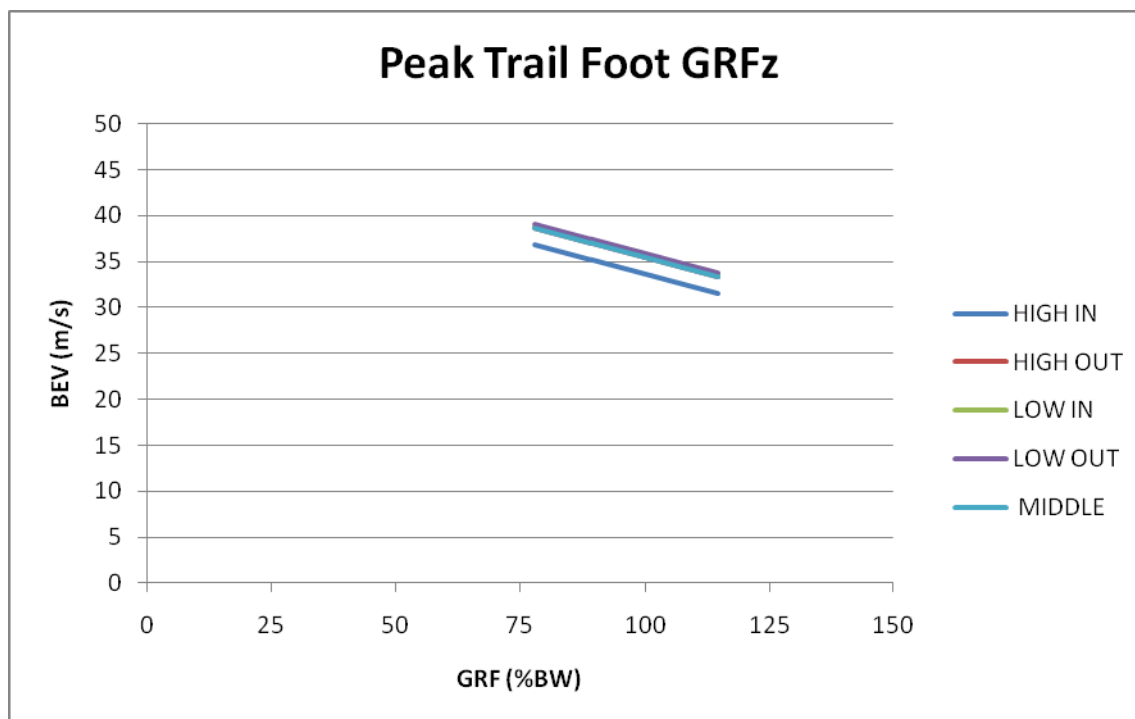

Figure 55. Model estimate of average BEV across value of peak trail foot GRFz.



## 4.2.2.32 Peak lead foot GRFx

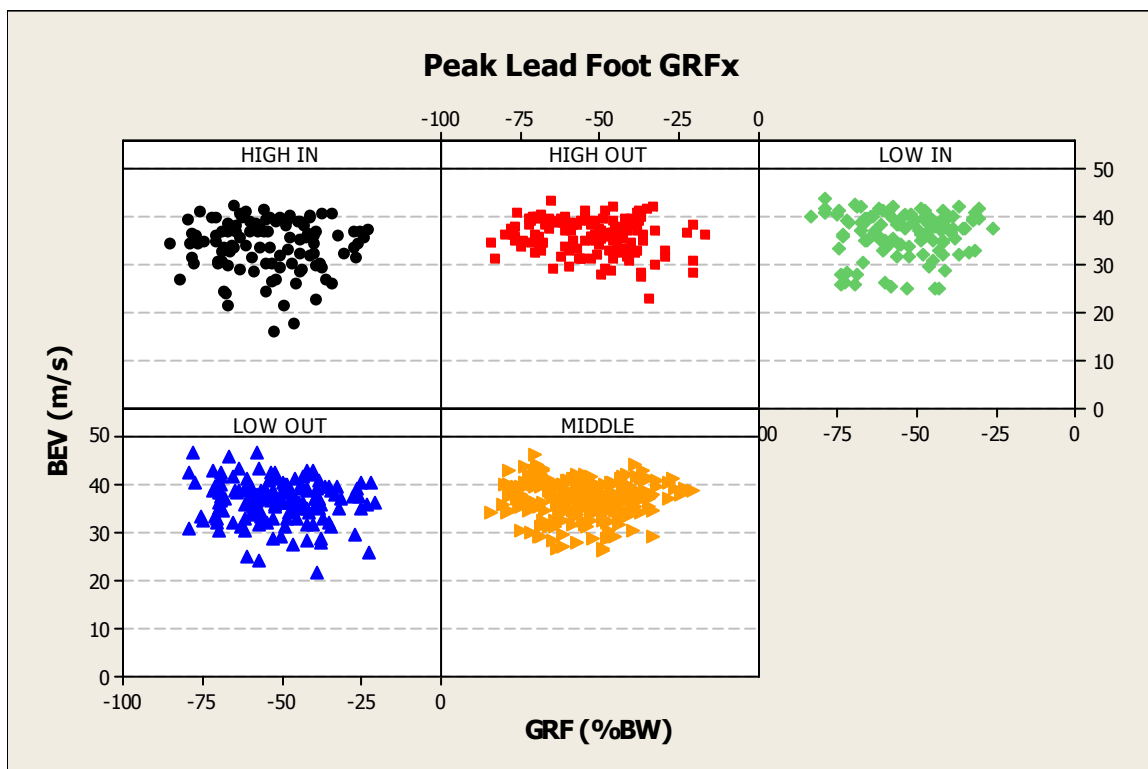

Figure 56. Peak lead foot GRFx across BEV (raw data)

Table 37. Analysis of variance for peak lead foot GRFx

Source	DF	Seq SS	Adj SS	Adj MS	F	P
LF GRFx	1	95.38	23.36	23.36	1.45	0.229
Subject	28	2137.57	2256.29	80.58	4.99	0.000
Location	4	757.83	676.36	169.09	10.47	0.000
PS	1	115.65	115.65	115.65	7.16	0.008
Error	692	11172.29	11172.29	16.14		
Total	726	14278.73				

As seen in Table 37, there was not a significant relationship between the peak lead foot GRFx and BEV. Thus no equation or graph of estimated BEV versus the peak lead foot GRFx was developed.

## 4.2.2.33 Peak lead foot GRFy

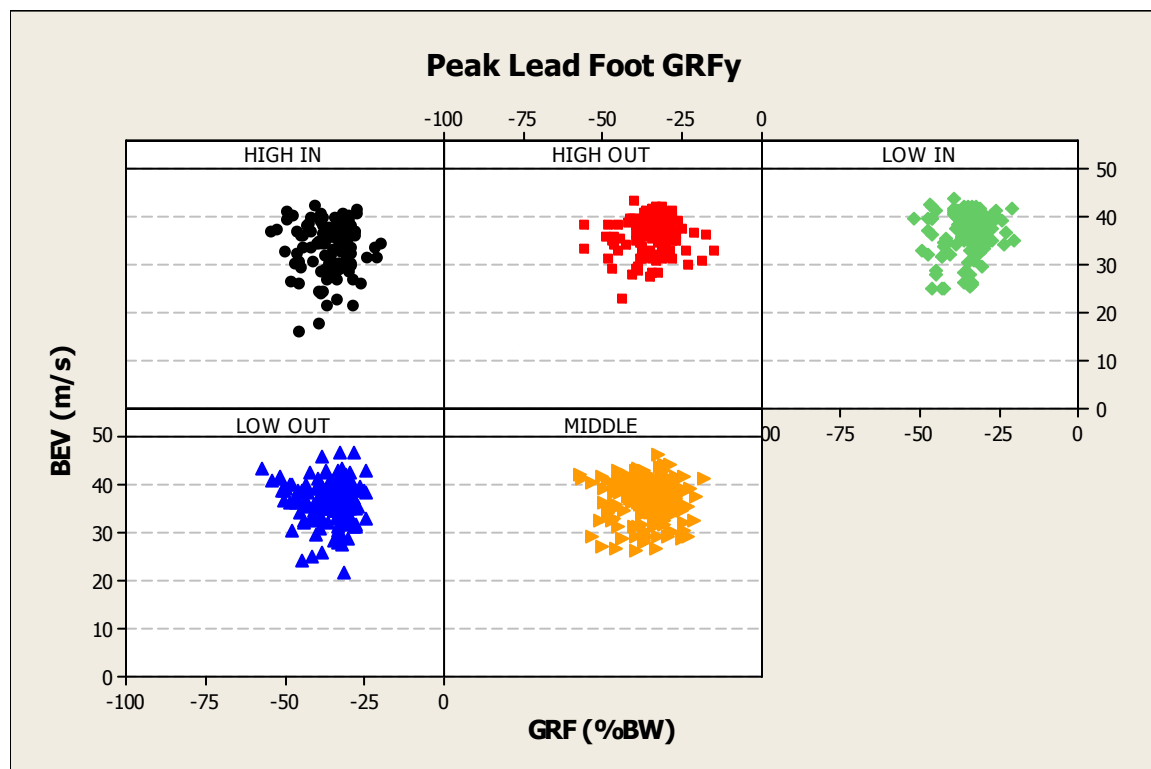

Figure 57. Peak lead foot GRFy across BEV (raw data)

Table 38. Analysis of variance for peak lead foot GRFy

Source	DF	Seq SS	Adj SS	Adj MS	F	P
LF GRFy	1	5.59	0.36	0.36	0.02	0.878
Subject	27	2064.24	821.17	30.41	1.98	0.002
Location	4	801.49	607.53	151.88	9.88	0.000
PS	1	152.49	178.45	178.45	11.61	0.001
Subject*LF GRFy	27	939.61	975.21	36.12	2.35	0.000
Subject*PS	27	683.27	683.27	25.31	1.65	0.022
Error	619	9518.02	9518.02	15.38		
Total	706	14164.70				

$$\text{Eq. 19: } BEV = 5.62 - 0.01 * \text{Lead Foot GRFy} + A * \mu + B * LOC + 1.15 * PS + C * \mu * \text{Lead Foot GRFy} + D * \mu * PS$$

In Eq. 19, the ranges for the coefficients were A: [-115.45 to 103.56], B: [HIGH IN = -1.92, HIGH OUT = 0.06, LOW IN = 0.18, LOW OUT = 0.55], C: [-1.22 to 0.82], and D: [-3.73 to 4.62]. In practicality, there was no significant group-wise association between peak lead foot GRFy and BEV. According to the model, the difference between

the minimum and maximum measured values of peak lead foot GRFy ( $-57.36\%$  BW and  $-14.53\%$  BW, respectively) would lead to a BEV difference of  $-0.34$  m/s. Figure 58 below visualizes the model-estimated BEV based on the range of measured values of peak lead foot GRFy.

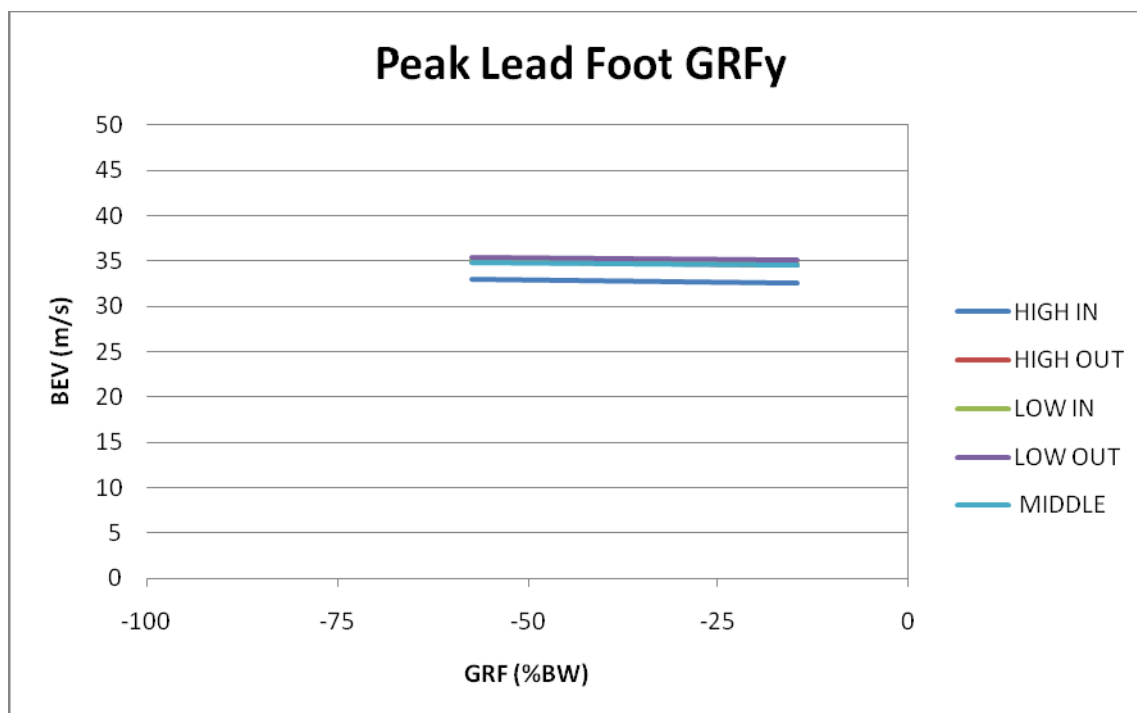

Figure 58. Model estimate of average BEV across values of peak lead foot GRFy.

## 4.2.2.34 Peak lead foot GRFz

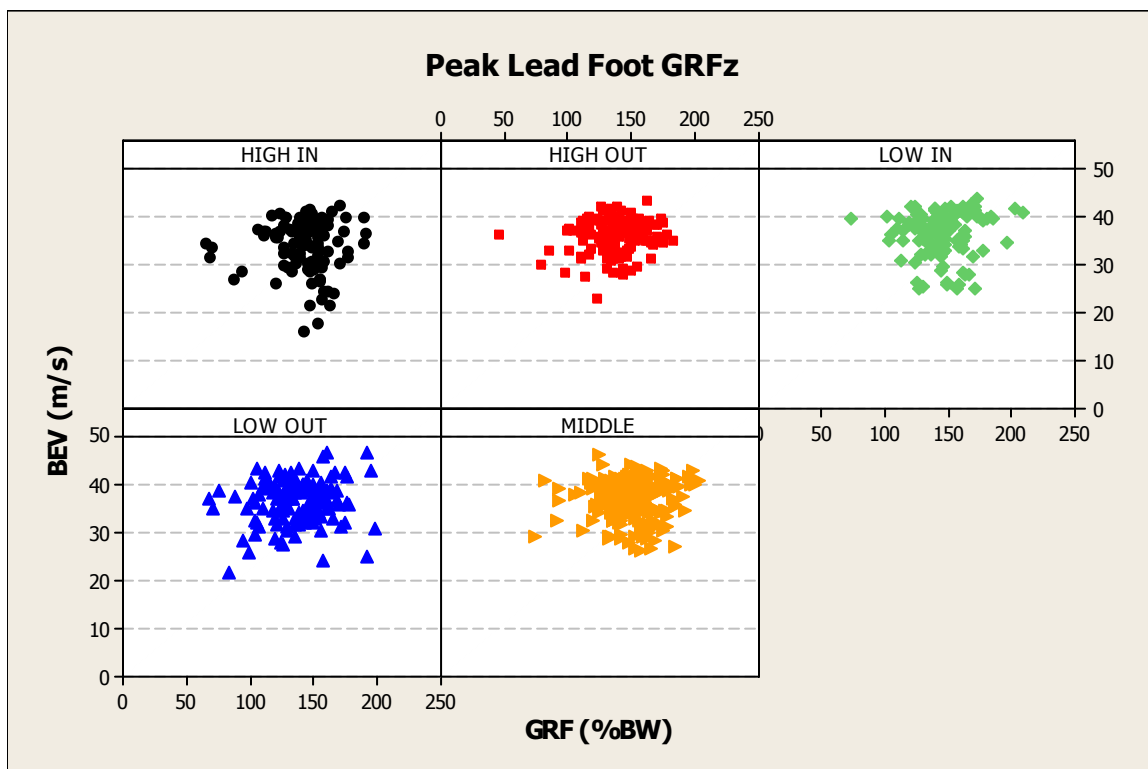

Figure 59. Peak lead foot GRFz across BEV (raw data)

Table 39. Analysis of variance for peak lead foot GRFz

Source	DF	Seq SS	Adj SS	Adj MS	F	P
LF GRFz	1	81.44	19.18	19.18	1.18	0.277
Subject	28	2119.47	2225.27	79.47	4.90	0.000
Location	4	769.25	701.81	175.45	10.82	0.000
PS	1	131.87	131.87	131.87	8.13	0.004
Error	687	11144.80	11144.80	16.22		
Total	721	14246.82				

As seen in Table 39, there was not a significant relationship between the peak lead foot GRFz and BEV. Thus no equation or graph of estimated BEV versus the peak lead foot GRFz was developed.

### 4.3 Comparison of swings by pitch type

Tables 40-44 display the mean and standard deviation values for the three trial types. For variables that had a significant difference among the trial types, the significant post-hoc pairwise comparisons are also noted. Three of the dependent variables (bat lag at BC, time of peak shoulder azimuth velocity, and time of peak trail foot GRFy) had to be transformed using the natural logarithm of the raw data in order to assume data normality. The GLM showed that all dependent variables had a significant subject effect, and in fact, those p-values were all less than .001. In these GLM, almost all dependent variables also showed a significant main effect for trial type as well. Only three variables, pelvis rotation angle at BC and peak trail foot GRFx and GRFz magnitude, were not statistically significant among the three trial types.

Table 40. Mean  $\pm$  SD of kinematic angles at BC among the three trial types (in degrees).

Variable	Change – Fail	Change – Success	Fast – Success
Lead Knee Flexion <sup>c</sup>	19 $\pm$ 10	20 $\pm$ 5	18 $\pm$ 4
Pelvis Rotation	76 $\pm$ 16	76 $\pm$ 12	77 $\pm$ 6
UT <sub>local</sub> Rotation <sup>b,c</sup>	-4 $\pm$ 10	-4 $\pm$ 6	-2 $\pm$ 4
Lead Shoulder Elevation <sup>a,c</sup>	71 $\pm$ 11	73 $\pm$ 5	70 $\pm$ 4
Lead Shoulder Azimuth <sup>a,b,c</sup>	-14 $\pm$ 10	-9 $\pm$ 9	-1 $\pm$ 8
Trail Elbow Flexion <sup>a,b,c</sup>	51 $\pm$ 18	67 $\pm$ 13	81 $\pm$ 8
Bat Lag <sup>a,b,c</sup>	34 $\pm$ 18	51 $\pm$ 3	65 $\pm$ 3
Bat Elevation <sup>a,b,c</sup>	-18 $\pm$ 13	-27 $\pm$ 8	-30 $\pm$ 5
Bat Azimuth <sup>a,b,c</sup>	46 $\pm$ 34	9 $\pm$ 14	-8 $\pm$ 12
Head Rotation <sup>a,b</sup>	43 $\pm$ 13	46 $\pm$ 7	47 $\pm$ 5

a) Significant difference between Change–Fail and Change–Success ( $p < .05$ )

b) Significant difference between Change–Fail and Fast–Success ( $p < .05$ )

c) Significant difference between Change–Success and Fast–Success ( $p < .05$ )

Table 41. Mean  $\pm$  SD of timing of peak kinematic velocity among the three trial types (in milliseconds relative to time of BC).

Variable	Change – Fail	Change –Success	Fast – Success
Lead Knee Extension <sup>a,b,c</sup>	-67 $\pm$ 47	-47 $\pm$ 30	-30 $\pm$ 25
Pelvis Rotation <sup>a,b,c</sup>	-109 $\pm$ 25	-88 $\pm$ 20	-71 $\pm$ 15
UT <sub>global</sub> Rotation <sup>a,b,c</sup>	-86 $\pm$ 25	-72 $\pm$ 17	-58 $\pm$ 14
Lead Shoulder Azimuth <sup>a,b,c</sup>	-73 $\pm$ 34	-55 $\pm$ 4	-46 $\pm$ 3
Trail Elbow Extension <sup>a,b,c</sup>	-8 $\pm$ 23	10 $\pm$ 3	16 $\pm$ 4
Bat Azimuth <sup>a,b,c</sup>	-24 $\pm$ 15	-16 $\pm$ 2	-10 $\pm$ 2

a) Significant difference between Change–Fail and Change–Success ( $p < .05$ )

b) Significant difference between Change–Fail and Fast–Success ( $p < .05$ )

c) Significant difference between Change–Success and Fast–Success ( $p < .05$ )

Table 42. Mean  $\pm$  SD of peak kinematic velocity magnitudes among the three trial types (in degrees per second).

Variable	Change – Fail	Change –Success	Fast – Success
Lead Knee Extension <sup>a,b,c</sup>	276 $\pm$ 102	299 $\pm$ 50	313 $\pm$ 41
Pelvis Rotation <sup>b,c</sup>	552 $\pm$ 108	557 $\pm$ 74	601 $\pm$ 38
UT <sub>global</sub> Rotation <sup>a,b,c</sup>	714 $\pm$ 163	742 $\pm$ 111	813 $\pm$ 71
Lead Shoulder Azimuth <sup>b,c</sup>	280 $\pm$ 100	300 $\pm$ 93	373 $\pm$ 92
Trail Elbow Extension <sup>b,c</sup>	1149 $\pm$ 260	1145 $\pm$ 12	980 $\pm$ 13
Bat Azimuth <sup>a,b</sup>	2720 $\pm$ 349	2488 $\pm$ 228	2486 $\pm$ 152

a) Significant difference between Change–Fail and Change–Success ( $p < .05$ )

b) Significant difference between Change–Fail and Fast–Success ( $p < .05$ )

c) Significant difference between Change–Success and Fast–Success ( $p < .05$ )

Table 43. Mean  $\pm$  SD of timing of peak GRF among the three trial types (in milliseconds relative to time of BC).

Variable	Change – Fail	Change –Success	Fast – Success
Trail Foot GRF <sub>x</sub> <sup>b,c</sup>	-489 $\pm$ 126	-496 $\pm$ 63	-420 $\pm$ 74
Trail Foot GRF <sub>y</sub> <sup>a,b,c</sup>	-166 $\pm$ 47	-141 $\pm$ 24	-130 $\pm$ 15
Trail Foot GRF <sub>z</sub> <sup>b,c</sup>	-614 $\pm$ 98	-579 $\pm$ 53	-511 $\pm$ 52
Lead Foot GRF <sub>x</sub> <sup>a,b,c</sup>	-115 $\pm$ 26	-100 $\pm$ 19	-90 $\pm$ 16
Lead Foot GRF <sub>y</sub> <sup>a,b,c</sup>	-169 $\pm$ 25	-144 $\pm$ 20	-135 $\pm$ 16
Lead Foot GRF <sub>z</sub> <sup>a,b,c</sup>	-126 $\pm$ 31	-107 $\pm$ 23	-93 $\pm$ 19

a) Significant difference between Change–Fail and Change–Success ( $p < .05$ )

b) Significant difference between Change–Fail and Fast–Success ( $p < .05$ )

c) Significant difference between Change–Success and Fast–Success ( $p < .05$ )

Table 44. Mean  $\pm$  SD of peak GRF magnitudes among the three trial types (in % BW).

Variable	Change – Fail	Change – Success	Fast – Success
Trail Foot GRFx	25 $\pm$ 5	25 $\pm$ 2	26 $\pm$ 2
Trail Foot GRFy <sup>a,b,c</sup>	23 $\pm$ 4	24 $\pm$ 3	28 $\pm$ 2
Trail Foot GRFz	98 $\pm$ 6	97 $\pm$ 2	97 $\pm$ 2
Lead Foot GRFx <sup>b,c</sup>	-53 $\pm$ 14	-50 $\pm$ 7	-56 $\pm$ 5
Lead Foot GRFy <sup>b,c</sup>	-32 $\pm$ 6	-32 $\pm$ 4	-36 $\pm$ 3
Lead Foot GRFz <sup>b,c</sup>	135 $\pm$ 24	137 $\pm$ 19	149 $\pm$ 12

a) Significant difference between Change–Fail and Change–Success ( $p < .05$ )

b) Significant difference between Change–Fail and Fast–Success ( $p < .05$ )

c) Significant difference between Change–Success and Fast–Success ( $p < .05$ )

While there were few practically relevant statistical differences in the lower body and trunk at BC among the three trial types, there were a number of statistically significant and practically relevant differences in the upper body and bat kinematics at BC (See Table 40). The lead shoulder was less horizontally adducted, the trail elbow was more extended, and the bat had rotated forward and was more elevated by BC for Change–Fail compared to Change–Success. The same pattern continued when comparing Change–Success to Fast–Success. The timing of all peak kinematic velocities was earlier for Change–Success than Fast–Success and earlier still for Change–Fail (See Table 41). The magnitudes of all peak kinematic velocities were generally the greatest in the Fast–Success, less in the Change–Success, and even less in Change–Fail, though there were a few exceptions (See Table 42). There was no difference in peak pelvis rotation velocity between Fast–Success and Change–Success. The peak trail elbow extension velocity was similar for Change–Success and Change–Fail, but it was significantly less for Fast–Success. Lastly, the peak bat azimuth velocity was significantly greater in Change–Fail than Change–Success or Fast–Success, with no difference between Change–Success and Fast–Success.

For the trail foot, there were no significant differences among trial types in the magnitude of GRFx or GRFz (See Table 44). There were also no differences between Change–Success and Fast–Success in the timing of the trail foot GRFx or GRFz, although Fast–Success occurred significantly closer to BC for both GRFx and GRFz (See Table 43). The pattern for trail foot GRFy was such that there were no differences between Change–Success and Change–Fail in the force magnitude though a peak GRFy was achieved significantly closer to BC for Change–Success than for Change–Fail (See Tables 43 and 44). The trail foot GRFy for Fast–Success occurred even closer to BC and with greater peak force. A similar pattern to trail foot GRFy was also manifested throughout the lead foot peak GRF data (See Tables 43 and 44). There were no significant differences in any of the peak GRF magnitudes between Change–Success and Change–Fail, but all of the peak GRF magnitudes were significantly greater for Fast–Success. For each of these GRF, the timing of their peaks was closest to BC for Fast–Success, earlier for Change–Success, and earlier still for Change–Fail.



## CHAPTER 5

### DISCUSSION

The skill of batting in baseball is essential for success in the sport, but nevertheless it has been labelled as the most difficult thing to do in sports (Mihoces, 2003). A wide variety of scientific and coaching literature on batting exists, describing basic biomechanical principles of the swing, exploring common coaching techniques and strategies, assessing the effects of factors such as vision, mental preparation, anthropometry, and strength and conditioning, and even quantifying changes in batting performance due to the physical properties of the bats and balls themselves. Using the data and insights provided in this library and simultaneously attempting to build on some of the limitations of previous research, the purpose of the current study was to comprehensively measure the biomechanics of the baseball swing. It was hoped that by advancing the scientific base of knowledge on batting, this information could help bridge the gaps among scientists, coaches, players, doctors, trainers, and fans curious to learn more and communicate more effectively about the fundamentals of the baseball swing.

#### 5.1 Description of swing

The first task of this study was to thoroughly describe the swing in biomechanical terms. This was done by averaging the successful results against fastballs down the middle for each batter, and then averaging all of the batters together to create the “typical” professional batter. Six phases were operationally defined: stance, stride, coiling, swing initiation, swing acceleration, and follow-through. These phases were derived from five key events (lead foot off, lead foot down, lead foot commitment, lead

foot maximum GRFz, and bat-ball contact), most of which had been documented by the majority of the previous biomechanical research discussed during the literature review.

During the stance phase, the upper body showed almost no movement at all, and the lower body only very slightly rocked back as the lead foot GRFx gently shifted the body's weight from the front foot towards the back foot. To help accept this extra body weight, the back knee flexed. With an average pitch speed (PS) of 25 m/s over a distance of approximately 13 m, the average flight time of the ball could be estimated at 520 ms. Since the event of lead foot off (which separates the stance and stride phases) occurred, on average, at -621 ms, it is likely that batters executed this first part of the swing before the ball had even been released from the pitcher's hand. The time of lead foot off in the current study correlates well with the batting tee studies of Welch et al. (1995) and Escamilla et al. (2009a,b), which reported average times of -570 ms, -586 ms, and -610 ms, respectively, but not as well with the batting tee study of Tago et al. (2006a,b), which had times of about -940 ms to -820 ms. The pitching machine study of Katsumata (2007) found a time of approximately -800 ms (based on graph estimates), while the live batting study of Mason (1987) had the lead foot off event occurring anywhere from -800 ms to -400 ms.

When looking at the graphs of trail foot GRF in the current study, the stride appears to be a rather "controlled fall" or "drift" forward rather than a violent, aggressive push. The trail foot GRFx, which would eventually propel the batter forward, held fairly constant around 21% BW throughout the phase. After accepting nearly all the body's weight (trail foot GRFz of  $92 \pm 9\%$  BW) near -500 ms, the trail knee began to slowly extend throughout the phase, though it did not reach a point of maximum extension until

halfway through the following phase (coiling). Welch and colleagues (1995) did not report the time of maximum trail foot GRFz, but their reported magnitude was slightly higher ( $102 \pm 3\%$  BW), as was Katsumata's (approximately 100% BW at  $-750$  ms). Many of the batter's body segments (pelvis, upper trunk, trail and lead shoulders, and bat) began to slightly counter-rotate during the stride phase, though these countermovements would not peak until the following phase (coiling). The stride length was measured as 42% of the batter's height and approximately 11 cm closed. These are slightly different than the stride values of Welch, which, when converted from their reported values, equated to roughly 46% of the batter's height and 17 cm closed. The lead foot returned to the ground around  $-340$  ms in the current study, slightly later than the time of Katsumata (about  $-400$  ms based on graph estimates) and just a bit earlier than Mason (1987), who found a time between  $-300$  ms and  $-200$  ms. The batting tee studies (Welch; Tago et al., 2006a,b; Escamilla et al., 2009a,b) all had the event of lead foot down occurring much closer to BC, ranging from  $-240$  ms to  $-175$  ms. It is logical to assume that these discrepancies in the event times are a direct effect of the methodologies employed by each of the studies. Not only could they be due to how the ball was delivered to the batter, but also the very definitions of the events. For example, Welch defined lead foot down as the instant when the foot made "full contact" with the ground, whereas the current study used a threshold of 10% BW lead foot GRFz.

The coiling phase was marked by the body coiling in a series of countermovements initiated during the stride phase. This coiling mechanism, which is commonly taught by coaches (Baker, Mercer & Bittinger, 1993; Gola and Monteleone, 2001; Williams & Underwood, 1986), helps to activate the stretch-shortening cycle found

in most dynamic movements, including baseball batting (Szymanski et al., 2007a). During coiling, the angles of pelvis tilt and rotation, upper trunk rotation, trail and lead shoulder azimuth, and bat azimuth all achieved maximum values in the opposite direction of the forward motion of the swing. Welch et al. (1995) saw a maximum counter-rotated pelvis position of  $-28^\circ$  at  $-350$  ms and maximum counter-rotated upper trunk position (with respect to global) of  $-52^\circ$  at  $-265$  ms, while the current study had those two segment positions occurring closer to BC and not quite as extreme in magnitude (pelvis:  $-21^\circ$  at  $-250$  ms; upper trunk:  $-22^\circ$  at  $-186$  ms). Again, it is suspected that these differences are primarily due to batters hitting balls off of a tee versus live pitching. Interestingly, while the coiling phase saw a number of these rotational movements, in the spirit of Ted Williams' coaching philosophy, the pelvis also moved linearly forward 11 cm in the X direction (towards the pitcher) during this phase, just as Charley Lau's philosophy emphasized. This again demonstrates that the batter must employ both rotational and linear movements, often simultaneously, to successfully execute his swing. In terms of GRF, batters seemed to have a fairly "soft" landing, as the lead foot GRFx and GRFz remained very low right after the lead foot returned the ground and only began to spike up towards the end of the phase, with a more rapid increase beginning around  $-200$  ms. This gentle landing is in keeping with a common coaching cue of striding as if stepping on thin ice (Baker, Mercer & Bittinger, 1993). The lead and trail foot GRFy, which oppose each other and occur at nearly the same time, intuitively seeming to serve as stabilizing forces during the swing, rose to over 80% of their eventual maximum values during this phase, helping to provide a steady base for the rotations further up the kinetic chain. The coiling phase terminated when the batter's lead foot GRFz reached

50% BW, which occurred at approximately  $-170$  ms. Though this weight shift commitment event is unique to this study, it is somewhat comparable to the “weighting” concept presented by Katsumata (2007).

During the swing initiation phase, most of the maximum GRF were produced, as the trail and lead foot GRFy peaked to fully stabilize the lower body, the lead foot GRFx acted as a brake to prevent further forward linear movement of the body’s weight and assisted in creating a strong “front side” (Gola & Monteleone, 2001; Robson, 2003), and the lead foot GRFz crescendoed to its peak value at the end of the phase to provide the initial energy that would be transmitted through the kinetic chain (DeRenne, 1993; Robson, 2003). The peak GRFy timing and magnitudes were very similar to those seen in Fortenbaugh & Fleisig (2008). Facilitating the increase in lead foot GRFz and the redirection of that force into the kinetic chain was the extension of lead knee from  $48^\circ$  to  $40^\circ$ , which reached about two-thirds of its peak extension velocity during the swing initiation phase. The current study saw a maximum lead foot GRFx of 50% BW at  $-83$  ms (technically just after the end of the swing initiation phase) and a maximum lead foot GRFz of 130% BW at  $-93$  ms (the defined end of the swing initiation phase).

Unfortunately, it is difficult to compare most of the other known studies of the GRF of the baseball swing to this instant in the swing. Welch et al. (1995) reported a total lead foot force of 123% BW, with X component 292 N and Z component 917 N at  $-175$  ms, though those numbers are relating the batter’s GRF at that research group’s definition of lead foot down. Mason (1987) found lead foot maximum GRFx of anywhere between 60% BW and 120% BW (time of occurrence not provided) and lead foot maximum GRFz of 200% BW to 250% BW at approximately  $-100$  ms. Katsumata’s (2007) data can only

be estimated from a graph, where it seems the maximum GRFz is approximately 130% BW at -150 ms. Fortenbaugh & Fleisig (2008), though analyzing swings off of a tee, did at least have comparable data, reporting a lead foot maximum GRFx and GRFz of 126% BW and 39% BW, respectively, with both occurring at -81 ms.

The swing initiation phase, much like the name suggests, is when many of the body segments began to move noticeably in the direction of the swing. Though the pelvis actually began to rotate during coiling, it moved much more rapidly during swing initiation, quickly opening up from  $-13^{\circ}$  to  $20^{\circ}$ , reaching over 95% of its peak velocity by the end of the phase. The upper trunk, meanwhile, had just begun to open in this phase, creating a bit of a lag, or separation, between the pelvis and upper trunk. This separation is what allowed for the stretch reflex to be activated in the trunk musculature, though the separation difference (measured as the upper trunk rotation with respect to the pelvis) peaked at  $18^{\circ}$  at around -103 ms, much less than what is seen in other rotational movements, such as baseball pitching (Stodden et al., 2001), golf swings (Cole & Grimshaw, 2009), and discus throws (Leigh & Yu, 2007). The only quasi-comparable value among the previous batting studies was the “trunk twist angle” the batting tee studies of Escamilla et al. (2009a,b) reported at the time when the batter’s hands started to move forward (roughly -130 ms), and that was only  $6^{\circ}$  to  $9^{\circ}$  of separation, though higher values of up to  $15^{\circ}$  were reported in the studies at earlier points in the swing.

During swing initiation, the batter’s arms finally began to move significantly, with the trail elbow tucking down and into the side of the body while the lead elbow also moved forward and down, though not as much. The elbows, however, remained fairly flexed, particularly the trail elbow. Failure to properly execute this early hand and arm

path leads to one of the most common hitting faults, “casting the hands” (Gola & Monteleone), so named because of its similarity to a fisherman casting a line by first extending his hands out and away from his body. Though the bat did begin to become unwrapped from behind the batter’s head during swing initiation, it still lagged far behind the body, as coaches often instruct their players (Robson, 2003). In fact, the bat lag angle actually increased to  $131^\circ$  during this phase, close to its maximum value. Due to the conservation of angular momentum, the change in bat azimuth while the hands were kept in close to the body allowed the bat rotate very quickly. Studying the graph of bat azimuth velocity, there were two distinct accelerations in bat azimuth: this first one during swing initiation which propelled the bat to nearly  $1250^\circ/\text{s}$ ; and the second, which propelled it to its maximum speed and occurred during the following phase of swing acceleration.

The most dynamic movements in the swing occurred between the time of lead foot maximum GRFz (around  $-93$  ms) and BC, aptly named the swing acceleration phase. During this time, the lead knee extended rapidly from  $40^\circ$  to  $18^\circ$ , peaking at a rate of  $263^\circ/\text{s}$  at  $-40$  ms, though this was markedly less than previous studies, which had reported  $350^\circ/\text{s}$  at approximately  $-199$  ms (Escamilla et al., 2009a) and  $386^\circ/\text{s}$  at  $-112$  ms (Escamilla et al., 2009b). The lead knee extension angles at BC of other studies, however, were quite similar, ranging from about  $11^\circ$  to  $20^\circ$  (Escamilla; Tago et al., 2006a,b; Welch et al., 1995). The pelvis moved through a substantial range of motion, not only rotating forward to face the pitcher, but also anteriorly tilting. The maximum pelvis rotation of  $581^\circ/\text{s}$  at  $-70$  ms in the current study was a bit less than Welch’s value of  $714^\circ/\text{s}$  though it occurred nearly at the same time ( $-75$  ms). One other study

(Escamilla, 2009b) reasonably matched these numbers with  $678^{\circ}/s$  at approximately  $-91$  ms, while another (Escamilla, 2009a) had a similar velocity of  $681^{\circ}/s$  but had it occurring much earlier at  $-234$  ms. The pelvis rotation angle at BC of  $77^{\circ}$  in the current study was right within the range of  $60^{\circ}$  to  $83^{\circ}$  seen in the other kinematic studies (Escamilla; Tago; Welch). The stretch that had been activated across the torso by the separation between pelvis and upper trunk rotation released during swing acceleration as the difference between the two angles nearly disappeared. Instants after the pelvis reached its peak velocity, the upper trunk followed suit, rotating even faster at a maximum speed of  $766^{\circ}/s$  at  $-57$  ms. Again, this was less in magnitude and similar in timing compared to Welch ( $937^{\circ}/s$  at  $-65$  ms) and Escamilla (2009b) ( $857^{\circ}/s$  at approximately  $-61$  ms), and different in magnitude and timing to Escamilla (2009a) ( $850^{\circ}/s$  at approximately  $-205$  ms). The global upper trunk angle at BC of  $75^{\circ}$  in the current study, however, was more open than the range of values of  $48^{\circ}$  to  $70^{\circ}$  previously reported (Escamilla, Tago, Welch).

Just after turning the pelvis and upper trunk through to face towards the pitcher, the batter continued to pass that rotational energy into the arms and bat. The lead shoulder continued to horizontally abduct, bringing the hands and knob of the bat across the chest as the elbows remained fairly flexed. By the time that the lead shoulder had reached its peak pre-contact azimuth velocity of  $342^{\circ}/s$  at  $-43$  ms, the lead elbow was flexed  $60^{\circ}$  and the trail elbow was flexed even more at  $107^{\circ}$ , though the trail elbow extension velocity had risen to over half of its maximum value. After reaching a peak, the lead shoulder azimuth velocity slowed while the trail elbow extension velocity continued to accelerate through BC, peaking at  $868^{\circ}/s$  at  $+17$  ms. Conserving angular momentum by keeping the hands close to the body as long as possible allowed the bat to



continue to accelerate, reaching its maximum azimuth velocity of  $2435^{\circ}/s$  just 10 ms before BC. While no previous biomechanical studies had measured the shoulder movements as the current study did, others had shown slightly greater trail elbow extension velocity, and had it occurring before BC. Welch et al. (1995) and Escamilla et al. (2009b) reported similar magnitudes and times to one another of  $948^{\circ}/s$  at  $-15$  ms and  $936^{\circ}/s$  at  $-20$  ms, respectively, while Escamilla et al. (2009a) had an elbow velocity of  $928^{\circ}/s$ , but at  $-123$  ms. Slower capture frame rates may have lead to erroneous estimates of the time of BC. As for the bat, Nicholls et al. (2003) and Nicholls et al. (2006) measured peak bat angular velocities of approximately  $2300^{\circ}/s$  to  $2350^{\circ}/s$ . While the bat's azimuth changed dramatically, the bat's elevation also changed noticeably during swing acceleration, dropping down nearly  $70^{\circ}$  to an orientation of  $30^{\circ}$  below parallel, leaving the bat barrel below the hands at BC, a goal that coaches look for hitters to achieve (Robson, 2003).

The follow-through phase, which encompassed all of the movements after BC, mainly saw the body's segments continuing to rotate forward as they had been in the swing, but in a decelerating manner to slow the body down as the batter theoretically transitioned from swinging into running towards first base. The one accelerating movement was a second horizontal adduction thrust by the lead shoulder. Though the lead shoulder movement that occurred during swing acceleration contributed more directly to the batter's swing velocity, the lead shoulder movement that occurred after BC may actually have implications for injury (Phillips, Andrews & Fleisig, 2000). A phenomenon known as the "batter's shoulder" is a posterior instability of the lead shoulder believed to be caused by excessive horizontal adduction of the lead shoulder

following contact. As seen in the graph in Appendix E, the large standard deviation surrounding the second peak in lead shoulder azimuth velocity indicates that there is quite a bit of variability among subjects, making some more likely to develop the batter's shoulder syndrome than others.

## 5.2 Modulation of swing to changes in pitch location

The effects of changes in pitch location on the biomechanics of the baseball swing were evaluated in two distinct ways. This particular analysis used only successful swings (i.e. balls hit in “fair territory”) against fastballs. First, 34 biomechanical parameters were separately compared to simply determine how these parameters varied with pitch location. The purpose of this first analysis was to see to what extent batters changed their swings when pitches were thrown in different parts of the strike zone. Second, since there was some variability in the ball exit velocity (BEV) of the batters' swings, these same 34 parameters were again individually assessed to identify if a given parameter had a significant relationship with BEV. The purpose of this second analysis was to help identify how batters modulated their swing biomechanics in order to optimize their results. The GLM, in essence, was a way to individually correlate the biomechanical parameters to BEV while still controlling for other pertinent factors. Before continuing with the breakdown of these results, it should be noted that there were a few limitations that directly affect the interpretation of these data. Both limitations are borne out of the maxim that models only apply to the data from which they were constructed. The batters faced PS below typical game speeds, though similar kinematic and kinetic timing and magnitudes were likely preserved because a shortened pitching distance kept the batters'

reaction times similar. Still, one cannot plug in real game-like PS (e.g. 40 m/s) and expect the models to be accurate. A second limitation is that the model-estimated BEV was computed based on the minimum and maximum measured values of the given biomechanical parameter and applied to all pitch locations, though the range of measured values varied from location to location. For example, the peak pelvis rotation velocity for HIGH IN ranged from 427.97°/s to 832.00°/s while the range for LOW OUT was 273.16°/s to 656.77°/s. Again, this limitation affects how broad of a range certain variables can be interpreted through the model.

Tracking the changes in swing biomechanics due to the effect of pitch location through the links of the kinetic chain, it is logical to begin such an investigation with the lower body's contributions. Most of the timing and magnitude of the peak GRF of both feet were practically, if not also statistically, insignificant. All of the trail foot GRF parameters, for all and intents and purposes, were the same for all pitch locations. The results did indicate, however, that having less peak trail foot GRFz led to increased BEV. Unfortunately, this effect is difficult to corroborate because there were no changes in BEV associated with changes in lead foot GRF magnitudes. The only peak lead foot GRF findings of note were that MIDDLE, HIGH IN, and LOW IN had significantly greater peak GRFz than LOW OUT and HIGH OUT and that peak GRFx and GRFz that occurred closer to the time of BC for all pitch locations were associated with increased BEV. The lead knee flexion angle at BC was similar among pitch locations, but there was significantly more peak lead knee extension velocity on inside pitches than outside pitches and the extension did occur significantly closer to BC. However, none of these knee parameters showed an association with BEV, indicating that the changes in knee

extension velocity with pitch location may just be the natural state of things rather than something that can be manipulated to improve performance.

The pelvis and upper trunk motions clearly showed the significant role they play in batting biomechanics. Ted Williams was a big proponent of the role of the pelvis and based a good portion of his hitting philosophy on its contribution to the swing (Williams & Underwood, 1986). In the current study, the pelvis rotated significantly faster and had a more open angle at BC on inside pitches than outside pitches. A more open pelvis rotation angle at BC was also associated with increased BEV, illustrating its importance. Gola & Monteleone (2001) also articulated this point, believing that hitters, particularly young hitters, can become overly concerned with missing the ball and will use only their arms to simply make contact at the expense of the power the pelvis can provide. Passing that energy up the chain, the current study found that the upper trunk rotated significantly faster for high pitches compared to low pitches. Since gravity can facilitate the bat's path to hitting low pitches much more so than high pitches, one may speculate that the batters in this study attempted to overcome that obstacle by rotating their upper trunk faster on the high pitches to ensure they could get the arms and bat in the proper position at BC. Though there was no significant association of peak upper trunk rotation velocity with BEV, the proposed theory of the batters' strategy is still supported by the fact that an earlier time of peak upper trunk rotation velocity for HIGH IN and a later time of peak upper trunk rotation velocity for LOW OUT were associated with increased BEV. These adjustments would logically put the batter in a more optimal position to direct the ball as desired (i.e. pull inside pitches and hit outside pitches to the opposite field) for a given pitch location.

The next link in the kinetic chain is the arms, and for this study, that meant focusing on the actions of the lead shoulder and the trail elbow. Since both of the arms are gripping the bat, the swing is a closed chain movement, meaning that both arms have to work together to move the hands along an efficient path. There is a great deal of irony in the findings of the two different statistical tests on the swing data of fastballs thrown to different locations. Looking at the comparative data, inside pitches had significantly greater shoulder azimuth at BC (i.e. more horizontal abduction), greater peak shoulder azimuth velocity, and less peak trail elbow extension velocity than outside pitches. The trail elbow was also flexed more at BC and had a later peak extension velocity for HIGH IN and a more extended position at BC with an earlier peak extension velocity for LOW OUT. However, the optimal shoulder and elbow kinematics revealed from the associations of these variables with BEV indicated that for HIGH IN, the lead shoulder should be less horizontally abducted and the trail elbow should be more extended at BC with the peak lead shoulder azimuth velocity and trail elbow extension velocity occurring earlier (relative to the time of BC), while for LOW OUT the lead shoulder should be more horizontally abducted at BC and the trail elbow should reach its peak extension velocity later (relative to the time of BC). The easiest explanation for these completely different hand paths is that as a group, the batters in this study simply struggled somewhat to successfully hit these two pitches. Especially for HIGH IN, the batters tended to pull in their hands in too close to the body, appearing to “fight off” the pitch rather than firing the hands out to meet the ball out in front of the plate as coaches suggest (Gola & Monteleone, 2001). It is very common for pitchers to routinely throw to these two opposing locations to challenge the batters, and the results of this study indicate

that this can be a good strategy for pitchers. Yet while the batters, as a group, did have significantly less BEV for HIGH IN than other locations (as seen in the results for biomechanical parameters that had a significant main effect with no LOC interaction), the significant associations of these biomechanical parameters with BEV demonstrate that there were also quite a few successful trials, meaning that the batters were able to demonstrate some proficiency, albeit not necessarily on a consistent basis.

The final link in the kinetic chain of batting is, of course, the bat itself. Not surprisingly, the bat elevation angle at BC was significantly greater on high pitches than low pitches. The bat azimuth at BC and peak bat azimuth velocity were greater on inside than outside pitches, meaning the batters likely snapped their wrist to get the barrel of the bat out in front of the plate on inside pitches but held back on outside pitches so as to position the bat in line with the opposite field (e.g. right field for right-handed batters). Though not as generalizable, greater bat azimuth at BC was associated with increased BEV for HIGH IN and less bat azimuth at BC was associated with increased BEV for LOW OUT. Similar to peak upper trunk rotation velocity, there was also a significant association of increased BEV with increased peak bat azimuth velocity on high pitches and decreased peak bat azimuth velocity on low pitches. A likely supposition is that the batters allowed gravity to accelerate the bat on low pitches but had to more forcibly rotate the bat to successfully hit high pitches. The time of peak bat azimuth velocity occurred, on average, before BC for all pitch locations. As well, earlier time of peak bat azimuth velocity was associated with increased BEV. These facts both point to the well-known motor control concept of the “speed-accuracy tradeoff” since the batters apparently were accelerating the bat to its peak rotational velocity before the time of contact and then

slowing it down just enough to optimize the quality of contact. Adair (2002) extensively describes the importance of making solid contact with the ball to maximize BEV. Lastly, while the batters adjusted the bat's orientation to optimize contact, they also rotated their heads accordingly to track the ball, turning less to hit HIGH IN and more to hit LOW OUT. These results are evidence that batters do attempt to "keep their eye on the ball" as coaches routinely preach (Baker, Mercer & Bittinger, 1993; Gola & Monteleone, 2001)

### 5.3 Modulation of swing to changes in pitch type

The ultimate goal of the pitcher is to get the batter out, and perhaps the most common strategy to achieve this is to throw a ball in the strike zone that the batter cannot hit. Many pitchers, particularly young and inexperienced ones, simply try to throw the ball extremely fast and rely on the pure physical challenge of the batter identifying the location of the pitch and appropriately timing his swing with reduced reaction time (due to pitch speed). More advanced pitchers tend use their guile to intermittently change the velocity, location, movement, and even the mere delivery of their pitches, trying to "fool" the batter by forcing him to constantly alter the timing and rhythm of his swing to match the pitch. In the current study, the comparison among successful swings fastballs (Fast–Success), successful swings against changeups (Change–Success), and unsuccessful swings against changeups (Change–Fail) revealed differences in 29 of the 32 biomechanical measurements (all but pelvis rotation at BC and peak magnitude of trail foot GRFx and GRFz), indicating very clearly that pitch type can affect batting mechanics and outcomes. As expected, the largest and most obvious differences were between the different pitches with opposing results, Fast–Success and Change–Fail. It is

even more intriguing to delve inside the numbers and discover to what extent the different pitch types affected batters' swings.

One way to break down the three trial types is to scan the post-hoc comparisons to see what variables were not statistically different between Fast–Success and Change–Success but were different for Change–Fail (marked in Tables 40-44 as ‘a’ and ‘b’), what variables were not statistically different between Change–Success and Change–Fail but were different for Fast–Success (marked in Tables 40-44 as ‘b’ and ‘c’), and finally, what made the three trial types unique (marked in Tables 40-44 as ‘a’, ‘b’, and ‘c’). Two variables were significantly different between successful swings (Fast–Success or Change–Success) and Change–Fail: head rotation at BC and peak bat azimuth velocity. The batters rotated their heads about 1° to 5° more towards the catcher and maximally rotated the bat about 105°/s to 275°/s slower for successful swings. Looking at these variables together, the logical assumption is that when the batter tracked the ball longer and took a more controlled swing (i.e. did not “overswing”) he was more successful in hitting the ball whether it was a fastball or a changeup. Whether the faster bat azimuth velocity of Change–Fail was a planned movement or a late, reactionary movement is unknown. Just as with the changes in pitch location, the concept of keeping one’s “eye on the ball” by tracking for as long as possible, however, is well-established throughout the coaching literature (Baker, Mercer & Bittinger, 1993; Gola & Monteleone, 2001).

A number of variables separated the Fast–Success from the Change–Success and Change–Fail, and many of these would logically be due to the pitch speed difference in fastballs and changeups. Differences in the timing of peak trail foot GRFx and GRFz can



very easily be explained by realizing that the batter likely took the exact same initial approach in his mechanics for all swings, and only after identifying a pitch type other than a fastball would he then begin to modify his swing (Gwynn, 1998). Since the peak trail foot GRFx and GRFz typically occurred very near the time at which the pitcher released the ball ( $-600$  ms to  $-400$  ms), the batter obviously had not yet identified the pitch type. A second difference was that all of the peak magnitudes of the lead foot GRF were reduced for swings against changeups as compared to fastballs. A plausible explanation for this difference is that the batter, after recognizing the pitch as a changeup, hesitated somewhat to commit his body weight to his lead foot as he normally would for a fastball. Three peak kinematic velocities were also significantly different for swings against fastballs and changeups. Fast–Success had around  $30^{\circ}/s$  to  $70^{\circ}/s$  more pelvis rotation velocity and roughly  $50^{\circ}/s$  to  $100^{\circ}/s$  more lead shoulder azimuth velocity than Change–Success or Change–Fail, but they also had  $100^{\circ}/s$  to  $200^{\circ}/s$  less trail elbow extension velocity than Change–Success or Change–Fail. Though all three trial types were statistically significant from one another for upper trunk rotation velocity, it was very nearly the case that the upper trunk displayed the same tendency as the pelvis and lead shoulder azimuth. To explain all of this, consider the theory of hesitation used to explain the reduced lead foot GRF magnitudes. Assuming there was a hesitation by the batter upon recognizing a changeup, this delay may have triggered a chain reaction of more passive, rather than aggressive, movements, including slower pelvis, upper trunk, and shoulder rotations. However, as the batter would have wanted to reach the bat out so as not to miss the ball completely, the latter links of the kinetic chain, including extension of the trail elbow, may have had to be sped up to try and get the bat in position.

The three trial types differed for a large number of biomechanical variables, though a distinct timing pattern typified their relationships. Using Fast–Success as a reference, the common pattern was that Change–Success had peak velocities and GRF occur a bit earlier and Change–Fail had them occur even earlier, though the precise amount of time varied a bit from variable to variable. This pattern was seen in the timing of all six peak kinematic velocities, the timing of peak trail foot GRFy, and the timing of all three peak lead foot GRF. The earlier occurrences of these movements can be assumed to mean that the batter, originally anticipating the ball to be coming at him with a fastball velocity and thus coordinating his movements for a swing against a fastball, simply prepared too early. In fact, while not studied in depth, a brief review of the data suggests that the sequence of movements of the kinetic chain and the time in between each movement remained fairly similar, just that the entire sequence was started prematurely. From another perspective, the timing differences between Fast–Success and Change–Success were about 5 ms to 15 ms for the GRF, 10 ms to 20 ms for lead knee extension and the pelvis and upper trunk rotational velocities, and 5 ms to 10 ms for the lead shoulder azimuth, trail elbow extension and bat azimuth velocities. The timing differences between Change–Success and Change–Fail had larger intervals, likely due to the fact that batters, if fooled substantially, could mistime the ball by quite a bit. These differences were roughly 10 ms to 30 ms for GRF and pelvis rotation velocities, 10 ms to 20 ms for upper trunk rotation, lead shoulder azimuth, and trail elbow extension velocities, and 5 ms to 10 ms for bat azimuth velocities. It was as if the batter was still fooled a little bit even for Change–Success, and then fooled bad enough to miss the ball entirely for Change–Fail. Other key variables that had distinct values for the three trial

types were lead shoulder azimuth, trail elbow flexion, bat lag, bat elevation, and bat azimuth at BC and lead knee extension velocity. All of these variables also exhibited a progression from Fast–Success to Change–Success to Change–Fail. Following that order, the progressions were to have less peak lead knee extension velocity and at BC to have less bat lag, greater lead shoulder azimuth, less trail elbow flexion, more bat elevation, and a greater bat azimuth. Amalgamating all of this data, one can quickly draw up a mental image of the rough, uncoordinated swing that a batter may take when unsuccessful in hitting a changeup compared to the smooth, graceful swing when successful against a fastball.

#### 5.4 Limitations to previous and current research

While the selected previous biomechanical studies of batting are helpful in validating some of the data of the current study, the number of differences that exist amongst the data suggest that the current study has produced rather unique results. As was proposed in the statement of the problem in the biomechanics of batting, scrutiny of the methodologies used by previous researchers shows woeful inadequacies in nearly every aspect of data collection, processing, analysis, and interpretation, though not every study is lacking in each of these areas. The main consequence of using such methodologies is that they do not replicate batting as it occurs in a game. A second consequence is that with a limited number of dependent variables collected and inferior methodology, the swing cannot be fully described. Complicating the issue is the very fact that some of the data are similar across most testing procedures, leading one to question what measurements are constant and what is variable amongst the protocols. As

stated, one of the aims of the current study was to improve the data collection methods to most accurately represent what batters do in a game. The researchers believe that they achieved this goal of more accurately representing the true game-like baseball swing through improvements in data collection, processing, and interpretation.

Still, the current study was saddled with a number of its own limitations, and some of these may have threatened the data's external validity to some extent when comparing it to the ideal situation of biomechanically assessing in-game actions. The first, and most obvious, limitation is that this study was collected in an indoor laboratory and not out on a baseball field. Players routinely take batting practice, as they did in the current study, in indoor facilities, without batting helmets, and wearing footwear other than baseball cleats, and the participants frequently commented to the researchers that they were fairly comfortable with the lab set-up. Still, hitting with minimal clothing and nearly 50 reflective markers attached to the body and bat does not seem preferable for the batters. Also, the caged environment with indoor lighting may have taken away some comfort provided in the typical sunny, open air feeling of hitting on a real field. Two other procedural limitations in the current study were the baseballs used and the pitching distance. The baseballs were covered entirely in reflective tape, converting a white ball with red seams, which batters can use to aid in pitch identification, into a solid grey ball. During testing, batters commented that they were reasonably comfortable with hitting the covered balls, but admitted that hitting regular baseballs with visible seams may aid them in pitch recognition. While pitching at a slower speed from a shorter distance than an actual game is standard for batting practice, this may not ideally reflect the reaction time of the batters during an at-bat, especially with reference to identifying off-speed pitches

like the changeup. A larger effect, as mentioned earlier in Section 5.2, is that the GLM developed to relate biomechanical parameters to BEV only holds true for the PS and conditions provided in this study and cannot be generalized to swings against a pitcher throwing the full pitching distance at game-like PS. One final, albeit minor, procedural limitation, is the difference between the overall rhythms of batting practice versus game at-bats. In the current study, each batter viewed between 40 and 70 pitches consecutively, swinging at the overwhelming majority of them, as they had been instructed. In a game, batters often see only a handful of pitches, perhaps only swing at one or two (depending on what offerings appeal to them), and then must wait their turn to bat again, anywhere from 10 minutes to 45 minutes later. Again, since they were accustomed to the style of batting practice implemented, the swings were probably similar to the game at-bats, but further studies could confirm this.

A few other limitations in the data capture and processing could have had some effect on the data as well. The current study captured the motions of batters considerably faster (300 Hz) than any previous study (200 Hz by Welch et al., 1995) and was likely more than sufficient for most of the body kinematics, but this was still probably not fast enough to precisely capture the instant that the bat contacted the ball. Some of the differences in timing, particularly regarding the bat, were only a few milliseconds. With the quantity of data assessed, a few milliseconds are probably both meaningful and believable, but still reflects only a frame or two worth of data. Adair (2002) claims the contact between bat and ball lasts just one millisecond, so a capture rate of up to 1000 Hz may be needed to guarantee accurate identification of the instant of BC and assist in defining the bat's motions. A second limitation stemmed from using the protective

batting cage. The netting of the cage, which provided a good deal of safety for the lab, also had the tendency to partially block some of the reflective markers, potentially leading to some small digitizing errors. While most of these errors were likely corrected by filtering the data, the use of larger markers, an alternative to the batting cage, and/or more cameras may have improved the accuracy of the motion capture. A third, very minor limitation is that defining a discrete pitch location for every trial even though pitches operate on a continuum may lead to some inaccuracies in the data's interpretation. However, the sheer wealth of data collected for this study should have evened out the few instances when a pitch location may have been categorized improperly.

## 5.5 Conclusions

This was the most comprehensive study on the biomechanics of baseball batting to date. Analyzing nearly 1300 trials from a fairly large sample of professional batters (N=33) facing a live batting practice pitcher throwing an assortment of fastballs and changeups to different locations, dozens of kinematic, kinetic, and temporal parameters were collected on each of the batters. Establishing a large database of biomechanical parameters on successful baseball swings against fastballs thrown “down the middle” was an important step in creating a reference source for those seeking to understand what values to expect for these parameters and also for those wishing to compare any individual batter against this database. The investigation of changes in swing mechanics against fastballs with changes in pitch location revealed a wealth of significant differences amongst the locations and how certain biomechanical parameters could influence BEV. While the lower body (i.e. GRF and lead knee) was fairly consistent for

all trials, the pelvis and upper trunk rotations were critical for increasing BEV. Batters were more successful when opening up the trunk more for inside pitches and less for outside pitches. The arms, operating in a closed chain with the both hands gripping the bat, worked in tandem to drive the hands to the optimal destination. For the best results, batters limited their shoulder horizontal abduction and extended the trail elbow for HIGH IN and alternatively increased shoulder abduction and flexed the trail elbow more for LOW OUT. However, the data revealed that batters did tend to struggle to execute these hand paths consistently. Successful swings also required batters to get the bat rotated around more at BC on inside pitches and less for outside pitches. A plethora of significant differences were also observed among successful swings against fastballs (Fast–Success), successful swings against changeups (Change–Success), and unsuccessful swings against changeups (Change–Fail). The pattern witnessed amongst these differences was that, compared to Fast–Success, the batter seemed to be fooled a little bit when successfully hitting a changeup and fooled a lot when unsuccessful in hitting a changeup. Batters all tended to have a similar approach during the stance, stride, and coiling phases, but began to differ more in the latter phases of the swing. A progressive delay among the three conditions demonstrated that the batters tended to prematurely initiate the events of the kinetic chain since hitters are generally taught to anticipate a fastball and then react to an off-speed pitch. Another pattern observed among these three conditions was that the batters appeared to use their lower body and trunk to generate more of the energy for Fast–Success, but they used their upper body more, particularly extension of the trail elbow, for Change–Success and Change–Fail.

While this study was primarily focused on generating data for biomechanists and other scientists, bridging the gap between those who work off the field and those who work on the field is paramount for any sports research. Based on the review of literature in batting, it is apparent that the skill of batting requires athletic development in biomechanics and motor control, vision and cognition, and strength and conditioning. Adjusting one's swing to various pitch locations and/or pitch speeds may involve, for example, increasing pelvis rotation or initiating the kinetic chain at the appropriate time, but it may also involve vision training for better and earlier pitch identification and improved strength, power, and flexibility to accommodate the necessary swing biomechanics. From a purely biomechanical standpoint, some preliminary advice to give to coaches based on this study are to have batters: (a) develop a strong, consistent approach for every swing in the early phases, particularly with the lower body; (b) anticipate a fastball for every pitch, but be able to recognize an off-speed pitch as early as possible; (c) use the powerful rotation of the pelvis to transfer the GRF and help direct the body according to the location of the incoming pitch; and (d) use the upper body to guide the hands along the appropriate path, putting the bat in a strong, properly angled position to direct the ball from its impact location to its desired destination on the field.

#### 5.6 Ideas for future work

Some things that may be considered limitations to the current study could also be construed as project ideas for the future. Any projects that could rectify any of the previously listed limitations of the current study would certainly be advantageous, particularly those that could address the issues of indoor batting (including lighting and



clothing), reflective tape covered baseballs, and pitching distance. One idea for the future is to use Major League Baseball players, rather than AA-level Minor League Baseball players, to try and capture the biomechanics of the true “elites” in the game. While many of the batters involved in the current study were considered top prospects, some differences between the two groups may exist. For that matter, future studies could also further explore college, high school, and youth batters and compare their results to these professionals. Another idea for the future would be to have a professional pitcher throw a “simulated game,” that is pitch to batters just as they would in a normal game, but without any fielders or baserunners. This would allow pitchers to mix in a variety of pitches and constantly rotate through a sequence of batters, maintaining the flow of a regular baseball game. A third idea, which would likely necessitate a higher capture rate, is to identify the location on the bat, and perhaps on the ball, where contact is made. The quality of contact assuredly affects the BEV, and therefore the outcome of the hit. Lastly, by collecting data on even more subjects for more trials, a greater possibility would exist for using that data for predictive purposes, as well as reducing any within-subject and between-subject variability. The current study basically used univariate models to relate each of the biomechanical parameters to BEV separately, but an influx of data could allow for more sensitive and robust multivariate models to predict BEV from full body swing biomechanics. An increase in data could also be processed through a discriminant analysis to determine the characteristics of successful and unsuccessful swings.

## REFERENCES

- Adair, R. (2002). *The physics of baseball*. New York: Harper.
- Bahill, A.T. (2004). The ideal moment of inertia for a baseball or softball bat. *IEEE Transactions on Systems, Man, and Cybernetics – Part A: Systems and Humans*, 34(2), 197-204.
- Baker, D., Mercer, J., & Bittinger, M. (1993). *You can teach hitting*. Carmel: Bittinger Books.
- Berra, Y. (1998). *The Yogi book: "I really didn't say everything I said"*. New York: Workman.
- Breen, J. L. (1967). What makes a good hitter? *Journal of Health, Physical Education, Recreation*, 38, 36-39.
- Broer, M. R., & Houtz, S. J. (1967). *Patterns of muscular activity in selected sport skills: an electromyographic study*. Springfield: Charles C. Thomas.
- Burroughs, W. A. (1984). Visual simulation training of baseball batters. *International Journal of Sports Psychology*, 15(2), 117-126.
- Carda, R.D. & Looney, M.A. (1994). Differences in physical characteristics in collegiate baseball players: a descriptive position by position analysis. *Journal of Sports Medicine & Physical Fitness*, 34(4), 370-376.
- Cassidy, P. E., & Wade, M. G. (1998). Improving novice baseball batters' choice reaction times through video training. *International Journal of Sports Vision*, 5(1), 22-32.
- Castaneda, B., & Gray, R. (2007). Effects of focus of attention on baseball batting performance in players of differing skill levels. *Journal of Sport & Exercise Psychology*, 29(1), 60-77.
- Cole, M.H. & Grimshaw, P.N. (2009). The X-factor and its relationship to golf performance. *Journal of Quantitative Analysis in Sports*, 5(1), 1134-1153.
- Coleman, A.E. & Lasky, L.M. Assessing running speed and body composition in professional baseball players. *Journal of Applied Sport Science Research*, 6(4), 207-213.
- Cross, R. (2009). Mechanics of swinging a bat. *American Journal of Physics*, 77(1), 36-43.
- DeRenne, C. (1993). *High-tech hitting: science vs. tradition*. St. Paul: West.

- DeRenne, C., Buxton, B.P., Hetzler, R.K. & Ho, K.W. (1995). Effects of weighted bat implement training on bat swing velocity. *Journal of Strength and Conditioning Research*, 9(4), 247-250.
- DeRenne, C., Ho, K.W., Hetzler, R.K. & Chai, D.X. (1992). Effects of warm up with various weighted implements on baseball bat swing velocity. *Journal of Applied Sport Science Research*, 6(4), 214-218.
- Dodd, D.J. & Alvar, B.A. (2007). Analysis of acute explosive training modalities to improve lower-body power in baseball players. *Journal of Strength and Conditioning Research*, 21(4), 1177-1182.
- Dragoo, B.A. (2003). Neuromotor control variables and their impact on select biomechanical parameters of the baseball swing. Ph.D. dissertation, Texas Woman's University, United States -- Texas. Retrieved June 1, 2009, from Dissertations & Theses: A&I database. (Publication No. AAT 3114317)
- Ebben, W.P., Hintz, M.J. & Simenz, C.J. (2005). Strength and conditioning practices of Major League Baseball strength and conditioning coaches. *Journal of Strength and Conditioning Research*, 19(3), 538-546.
- Escamilla, R.F., Fleisig, G.F., DeRenne, C., Taylor, M.K., Moorman, III, C.T., Imamura, R., Barakatt, E., Andrews, J.R. (2009). Effects of bat grip on baseball hitting kinematics. *Journal of Applied Biomechanics*, 25(3), 203-209.
- Escamilla, R.F., Fleisig, G.F., DeRenne, C., Taylor, M.K., Moorman, III, C.T., Imamura, R., Barakatt, E., Andrews, J.R. (2009). A comparison of age level on baseball hitting kinematics. *Journal of Applied Biomechanics*, 25(3), 210-218.
- Feltner, M. & Dapena, J. (1989). Three-dimensional interactions in a two-segment kinetic chain. Part I: general model. *International Journal of Sport Biomechanics*, 5(4), 403-419.
- Fleisig, G.S., Zheng, N., Stodden, D.F. & Andrews, J.R. (2002). Relationship between bat mass properties and bat velocity. *Sports Engineering*, 5, 1-8.
- Fortenbaugh, D., & Fleisig, G. (2008). *Ballpark forces: Ground reaction forces during batting*. Poster session presented at the International Symposium on Biomechanics in Sports, Seoul, South Korea.
- Garhammer, J. (1983). Kinesiological analysis of hitting for baseball. *National Strength & Conditioning Association Journal*, 5(2), 6-7,70-71.
- Gelinas, M., & Hoshizaki, T.B. (1988). *Kinematic characteristics of opposite-field hitting*. Paper presented at the International Symposium on Biomechanics in Sports, Bozeman, MT.

- Gola, M., & Monteleone, J. (2001). *The complete book of hitting faults and fixes*. New York: McGraw-Hill.
- Gray, R. (2002). Behavior of college baseball players in a virtual batting task. *Journal of Experimental Psychology*, 28(5), 1131-1148.
- Gray, R. (2002). Markov at the bat: A model of cognitive processing in baseball batters. *Psychological Science*, 13(6), 542-547.
- Gwynn, T. (1998). *The art of hitting*. New York: GT.
- Hills, J. (2005). *Hip range of motion asymmetries in baseball hitters*. Unpublished master's thesis, University of Toledo, Toledo, OH.
- Hirano, Y. (1986). *Biomechanical analysis of baseball hitting*. Paper presented at the International Symposium on Biomechanics in Sports, Halifax, Nova Scotia, Canada.
- Hirano, Y., & Murata, M. (2003). *Effects of ball movement and position at impact on grip firmness in baseball batting*. Paper presented at the International Society of Biomechanics XIXth Congress, Dunedin, New Zealand.
- Hubbard, A.W., & Seng, C.N. (1954). Visual movements of batters. *Research Quarterly*, 25(1), 42-57.
- Hughes, S. S., Lyons, B. C., & Mayo, J. J. (2004). Effect of grip strength and grip strengthening exercises on instantaneous bat velocity of collegiate baseball players. *Journal of Strength and Conditioning Research*, 18(2), 298-301.
- Hyllegard, R. (1991). The role of baseball seam pattern in pitch recognition. *Journal of Sport & Exercise Psychology*, 13(1), 80-84.
- Jinji, T., & Sakurai, S. (2006). Direction of spin axis and spin rate of the pitched baseball. *Sports Biomechanics*, 5(2), 197-214.
- Katsumata, H. (2007). A functional modulation for timing a movement: a coordinative structure in baseball hitting. *Human Movement Science*, 26(1), 27-47.
- Kauffman, I. B., & Greenisen, M. C. (1973). *Analysis of the validity of warm up with a weighted baseball bat*. Paper presented at the annual meeting of the American Society of Mechanical Engineers, Detroit, MI.
- Kitzman, E. W. (1964). Baseball: electromyographic study of batting swing. *Research Quarterly*, 35(2), 166-178.

- Kohmura, Y., Aoki, K., Yoshigi, H., Sakuraba, K. & Yanagiya, T. (2008). Development of a baseball-specific battery of tests and a testing protocol for college baseball players. *Journal of Strength and Conditioning Research*, 22(4), 1051-1058.
- LaBranche, M. J. (1994). *Effect of batting stance on ground reaction forces, bat velocity, and response time*. Unpublished master's thesis, Springfield College, Springfield, MA.
- Lau, C., & Glossbrenner, A. (1984). *The winning hitter: How to play championship baseball*. New York: Hearst.
- Leigh, S., & Yu, B. (2007). The associations of selected technical parameters with discus throwing performance: a cross-sectional study. *Sports Biomechanics*, 6(3), 269-284.
- Liu, C., Tseng, K.-G., Chung, C.-W., Kao, Y.-C., & Shiang, T.-Y. (2005). Design of simulative pitching machine and its effect. Poster session presented at International Symposium of Biomechanics in Sports, Beijing, China.
- Mason, B. (1985). *Ground reaction forces of elite Australian baseball batters*. Presented at International Symposium for Biomechanics in Sports, Greeley, CO.
- Matsuo, T., & Kasai, T. (1994). Timing strategy of baseball-batting. *Journal of Human Movement Studies*, 27(6), 253-269.
- Matsuo, T., Kasai, T., & Asami, T. (1993). The improvement of coincidence anticipation timing task with bat-swing. *Journal of Human Movement Studies*, 25(3), 99-119.
- Mihoces, G. (2003, March 3) 10 hardest things to do in sports: Part III. *USA Today*, p. 3C.
- McIntyre, D. R., & Pfautsch, E. W. (1982). A kinematic analysis of the baseball batting swings involved in opposite-field and same field hitting. *Research Quarterly for Exercise and Sport*, 53(3), 206-213.
- McLean, S. P., & Reeder, M. S. (2000). Upper extremity kinematics of dominant and non-dominant side batting. *Journal of Human Movement Studies*, 38(4), 201-212.
- McPherson, S. L. (1993). The influence of player experience on problem solving during batting preparation in baseball. *Journal of Sport & Exercise Psychology*, 15(3), 304-325.
- McPherson, S. L., & MacMahon, C. (2008). How baseball players prepare to bat: tactical knowledge as a mediator of expert performance in baseball. *Journal of Sport and Exercise Psychology*, 30(6), 755-778.
- Nathan, A. (2003). Characterizing the performance of baseball bats. *American Journal of Physics*, 71(2), 134-143.

Nicholls, R.L., Elliott, B.C., Miller, K., & Koh, M. (2003). Bat kinematics in baseball: implications for ball exit velocity and player safety. *Journal of Applied Biomechanics*, *19*(4), 283-294.

Nicholls, R.L., Miller, K. & Elliot, B.C. (2006). Numerical analysis of maximal bat performance in baseball. *Journal of Biomechanics*, *39*(6), 1001-1009.

Noble, L., & Harms, N. (2004). *Relative effects of warm-up with underweight, overweight, and standard weight bats on bat velocity and segmental movement*. Poster session presented at International Symposium for Biomechanics in Sports, Ottawa, Ontario, Canada.

Otsuji, T., Abe, M. & Kinoshita, H. (2002). After-effects of using a weighted bat on subsequent swing velocity and batters' perceptions of swing velocity and heaviness. *Perceptual & Motor Skills*, *94*(1), 119-126.

*Page 2 - Sports skills difficulty rankings*. (n.d.). Retrieved April 23, 2009, from espn.com: <http://sports.espn.go.com/espn/page2/sportSkills>

Paull, G., & Glencross, D. (1997). Expert perception and decision making in baseball. *International Journal of Sport Psychology*, *28*(1), 35-56.

Penrose, J.M.T. & Hose, D.R. (1999). An impact analysis of a flexible bat using an iterative solver. *Journal of Sports Sciences*, *17*(8), 677-682.

Phillips, B.B., Andrews, J.R. & Fleisig, G.S. (2000). Batter's shoulder: posterior instability of the lead shoulder, a biomechanical evaluation. Birmingham: Alabama Sports Medicine and Orthopaedic Center.

Race, D.M. (1961). A cinematographic and mechanical analysis of the external movements involved in hitting a baseball effectively. *Research Quarterly*, *32*(3), 394-404.

Rhea, M.R., Oliverson, J.R., Marshall, G., Peterson, M.D., Kenn, J.G. & Ayllon, F.N. (2008). Noncompatibility of power and endurance training among college baseball players. *Journal of Strength and Conditioning Research*, *22*(1), 230-234.

Robson, T. (2003). *The hitting edge*. Champaign: Human Kinetics.

Sawicki, G.S., Hubbard, M. & Stronge, W.J. (2003). How to hit home runs: optimum baseball bat swing parameters for maximum range trajectories. *American Journal of Physics*, *71*(11), 1152-1162.

Scott, S. A., & Gray, R. D. (2007). *Specificity of practice in baseball batting*. Poster session presented at the annual meeting for the North American Society for Psychology of Sport and Physical Activity, San Diego, CA.

Sergo, C. & Boatwright, D. (1993). Training methods using various weighted bats and the effects on bat velocity. *Journal of Strength and Conditioning Research*, 7(2), 115-117.

Shaffer, B., Jobe, F. W., Pink, M., & Perry, J. (1993). Baseball batting: an electromyographic study. *Clinical Orthopaedics and Related Research*, 292, 285-293.

Sherwood, J.A., Mustone, T.J. & Fallon, L.P. (2000). *Characterizing the performance of baseball bats using experimental and finite element methods*. Presented at the 3<sup>rd</sup> International Conference on the Engineering of Sport, Sydney, Australia.

Slater-Hammel, A. T., & Stumpner, R. L. (1950). Batting reaction-time. *Research Quarterly*, 21(4), 353-356.

Slater-Hammel, A. T., & Stumpner, R. L. (1951). Choice batting reaction-time. *Research Quarterly*, 22, 377-380.

Smith, L.V. (2001). Evaluating baseball bat performance. *Sports Engineering*, 4, 205-214.

Southard, D. & Groomer, L. (2003). Warm-up with baseball bats of varying moments of inertia: effect on bat velocity and swing pattern. *Research Quarterly for Exercise & Sport*, 74(3), 270-276.

Stodden, D.F., Fleisig, G.S., McLean, S.P., Lyman, S.L. & Andrews, J.R. (2001). Relationship of pelvis and upper torso kinematics to pitched baseball velocity. *Journal of Applied Biomechanics*, 17(2), 164-172.

Swimley, P. S. (1964). *A cinematographic analysis of two selected baseball swings*. Unpublished master's thesis, Sacramento State College, Sacramento, CA.

Szymanski, D.J., McIntyre, J.S., Szymanski, J.M., Bradford, T.J., Schade, R.L., Madsen, N.H. & Pascoe, D.D. (2007). Effect of torso rotational strength on angular hip, angular shoulder, and linear bat velocities of high school baseball players. *Journal of Strength and Conditioning Research*, 21(4), 1117-1125.

Szymanski, D.J., McIntyre, J.S., Szymanski, J.M., Molloy, J.M., Madsen, N.H. & Pascoe, D.D. (2006). Effect of wrist and forearm training on linear bat-end, center of percussion, and hand velocities and on time to ball contact of high school baseball players. *Journal of Strength and Conditioning Research*, 20(1), 231-240.

Szymanski, D.J., Szymanski, J.M., Bradford, T.J., Schade, R.L. & Pascoe, D.D. (2007). Effect of twelve weeks of medicine ball training on high school baseball players. *Journal of Strength and Conditioning Research*, 21(3), 894-901.

- Szymanski, D.J., Szymanski, J.M., Molloy, J.M. & Pascoe, D.D. (2004). Effect of 12 weeks of wrist and forearm training on high school baseball players. *Journal of Strength and Conditioning Research*, 18(3), 432-440.
- Tago, T., Ae, M., & Koike, S. (2005). *The trunk twist angle during baseball batting at the different hitting points*. Poster session presented at International Society for Biomechanics XXth Congress, Cleveland, OH.
- Tago, T., Ae, M., Fujii, N., Koike, S., Takahashi, K., & Kawamura, T. (2006). Effects of height of hitting point on joint angular kinematics in baseball batting. *Japanese Journal of Biomechanics*, 10(1), 2-13.
- Tago, T., Ae, M., Fujii, N., Koike, S., & Kawamura, T. (2006). Effects of inside and outside hitting point on joint angular kinematics in baseball batting. *Japanese Journal of Biomechanics*, 10(4), 222-234.
- Thwaites, R. (2005). *The effects of isometric strength and bat moment of inertia on bat velocity in baseball hitters*. Unpublished master's thesis, Queensland University of Technology, Brisbane, Australia.
- Weimer, B., Halet, K. & Anderson, T. (2007). Relationship of strength variables to bat velocity in college baseball and softball players. *Missouri Journal of Health, Physical Education, Recreation & Dance*, 17, 53-59.
- Welch, C. M., Banks, S. A., Cook, F. F., & Draovitch, P. (1995). Hitting a baseball: a biomechanical description. *Journal of Orthopaedic & Sports Physical Therapy*, 22(5), 193-201.
- Williams, T., & Underwood, J. (1986). *The science of hitting*. New York: Simon & Schuster.
- Winter, D. A. (1990). *Biomechanics and motor control of human movement, 2nd Ed.* New York: Wiley.
- Yanai, T. (2007). *A mechanical cause of body rotation about the vertical axis in baseball batting*. Poster session presented at the annual meeting of the American Society of Biomechanics, Cleveland, OH.



APPENDIX A:  
Informed Consent



**AMERICAN SPORTS MEDICINE INSTITUTE  
JAMES R. ANDREWS, M.D. BIOMECHANICS LABORATORY**

**Consent Form - Hitting Analysis**

I, \_\_\_\_\_, having attained my nineteenth birthday and otherwise having full capacity to consent, do hereby volunteer to participate in a study titled *Biomechanical Analysis of Batting*, under the direction of Glenn Fleisig, Ph.D. and Dave Fortenbaugh, MS. ASMI and St. Vincent's Fitness Center accept no responsibility for any injury I incur while batting or exercising.

The implications of my voluntary participation, the nature, duration, and purpose; the methods and means by which the study is to be conducted; and the inconveniences and hazards to be expected have been thoroughly explained to me. I have been given an opportunity to ask questions concerning this investigation and these questions have been answered to my complete satisfaction. Any data generated from this test including photographs and video taken during the test may be used for future research studies, the ASMI website, and/or presentations.

I understand that I may, at any time during the course of this investigation, revoke my consent and withdraw from the study without prejudice.

\_\_\_\_\_  
Signature

\_\_\_\_\_  
Date

APPENDIX B:  
Diagrams of Kinematic Variables

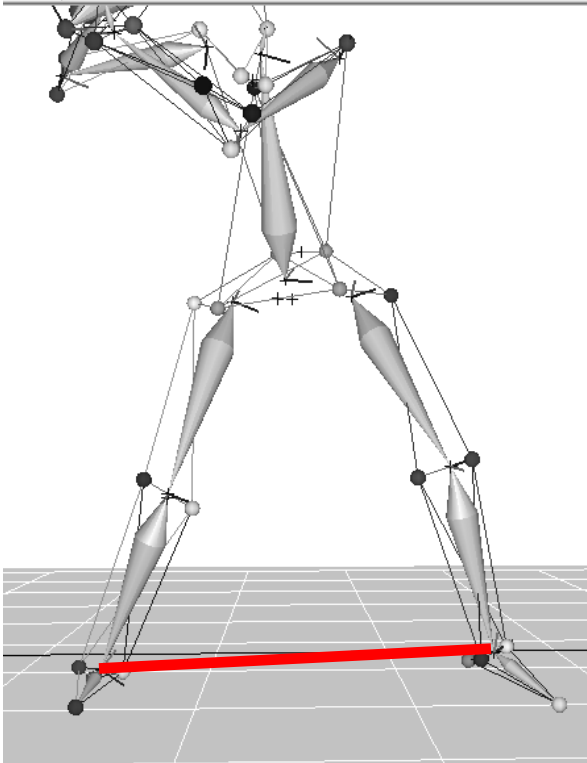

Stride length

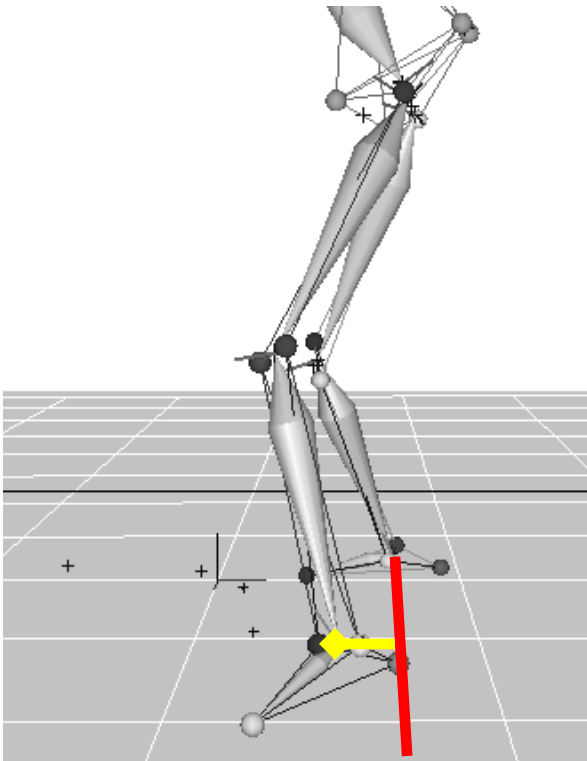

Stride direction

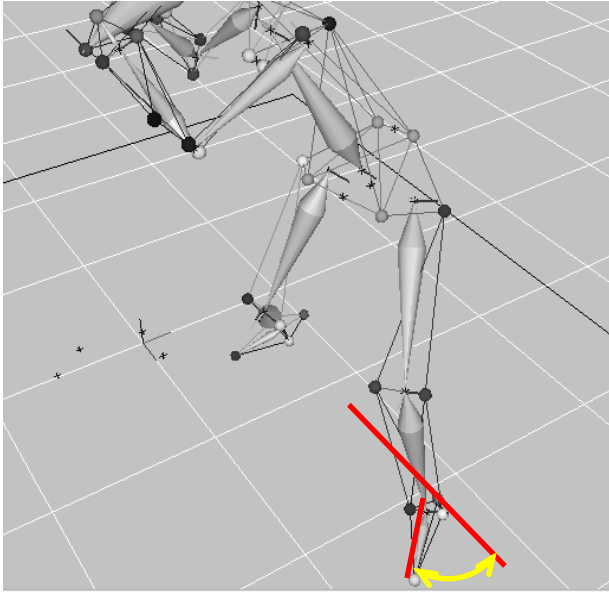

Lead foot

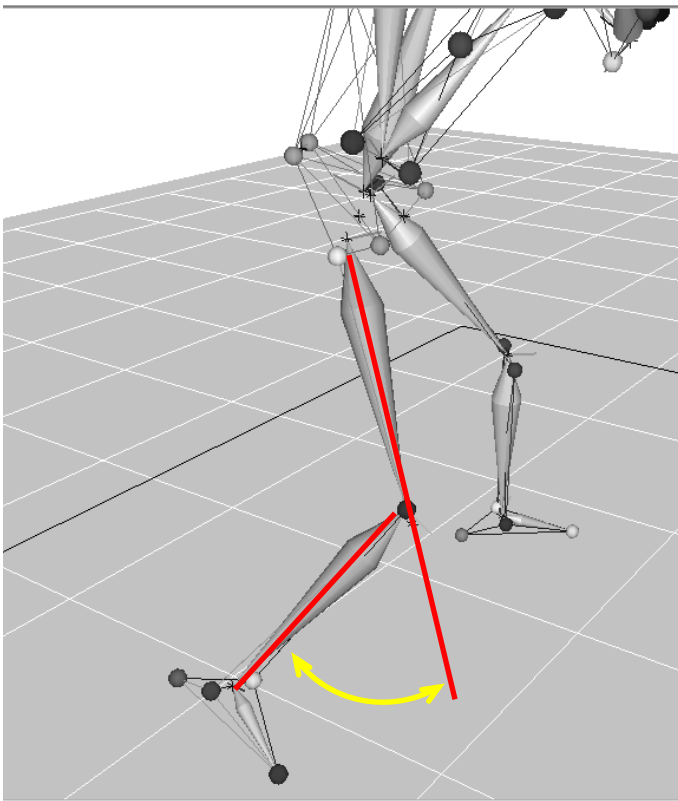

Trail knee flexion

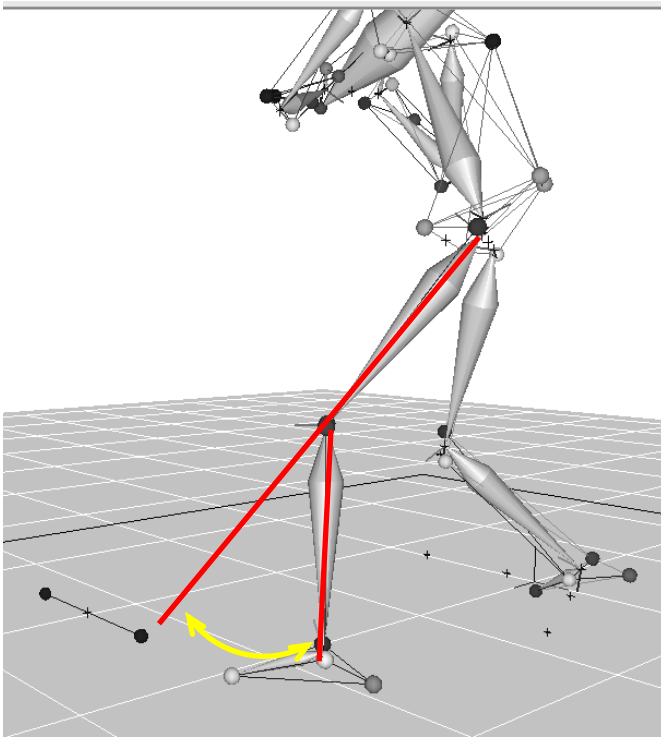

Lead knee flexion

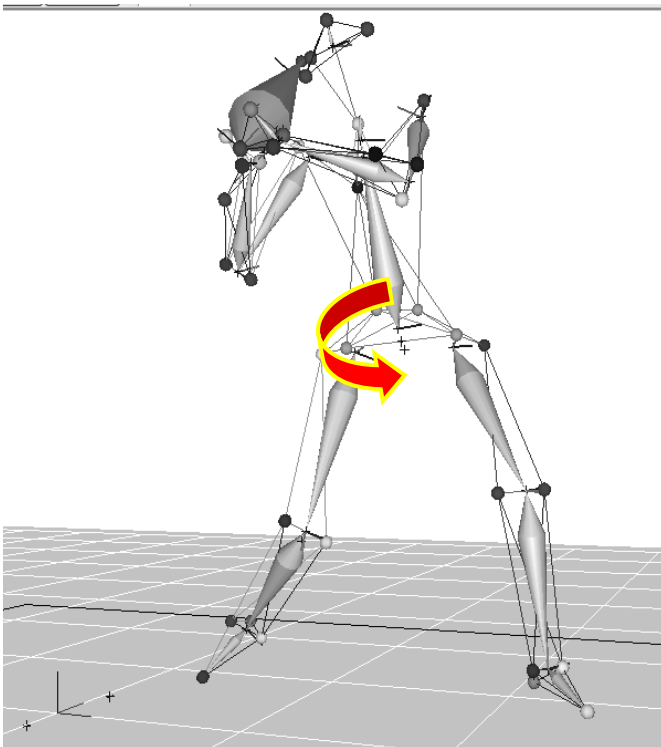

Pelvis rotation

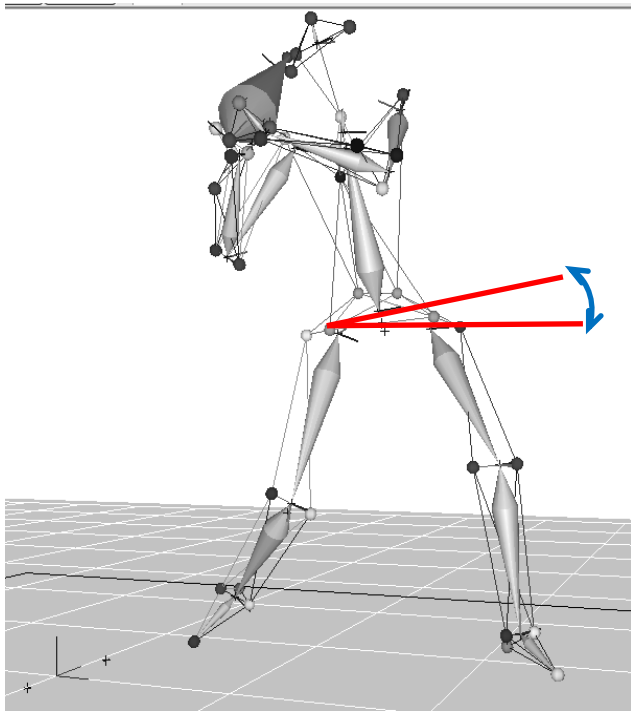

Pelvis obliquity

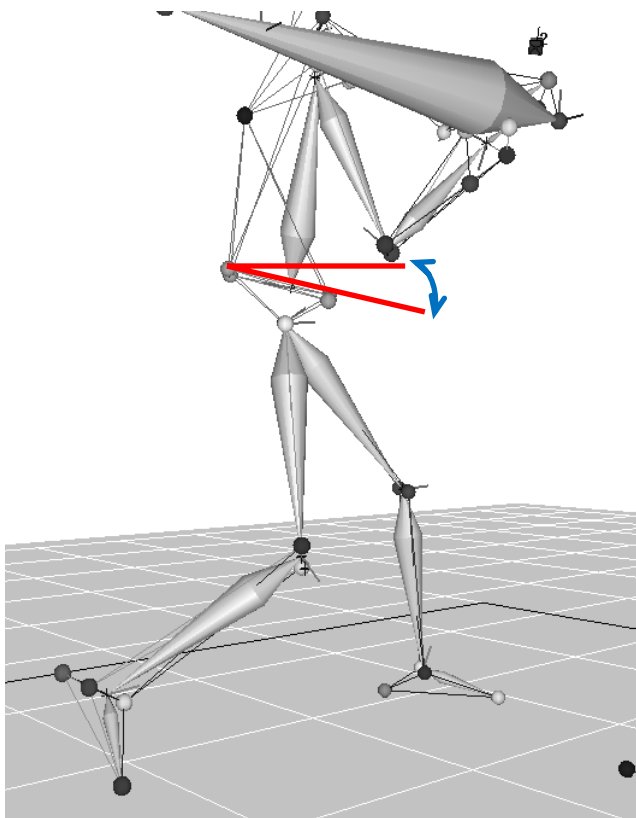

Pelvis tilt

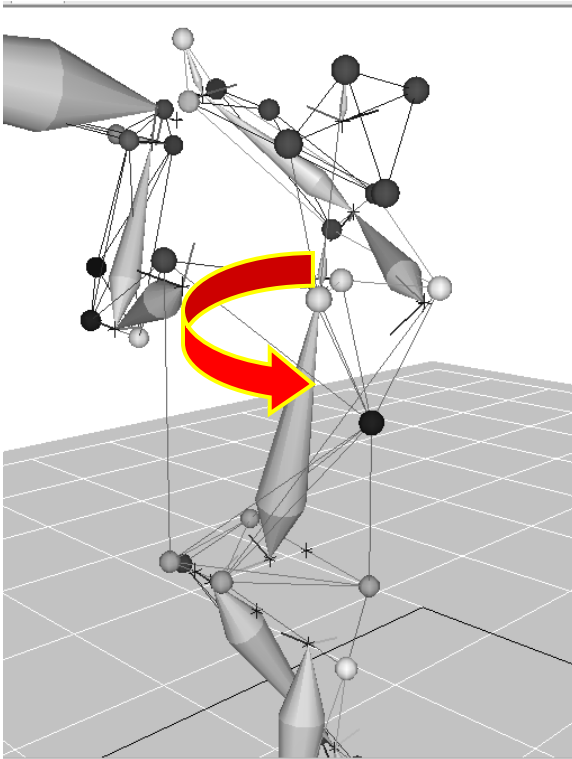

Upper trunk rotation

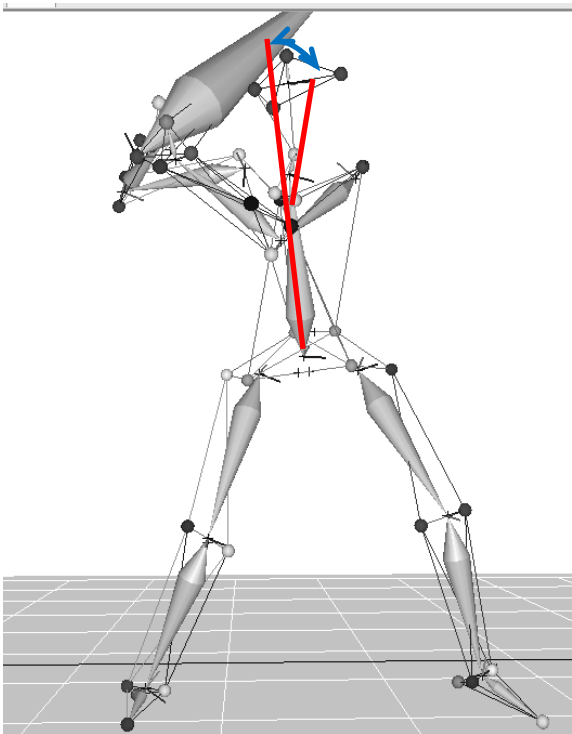

Upper trunk lateral flexion



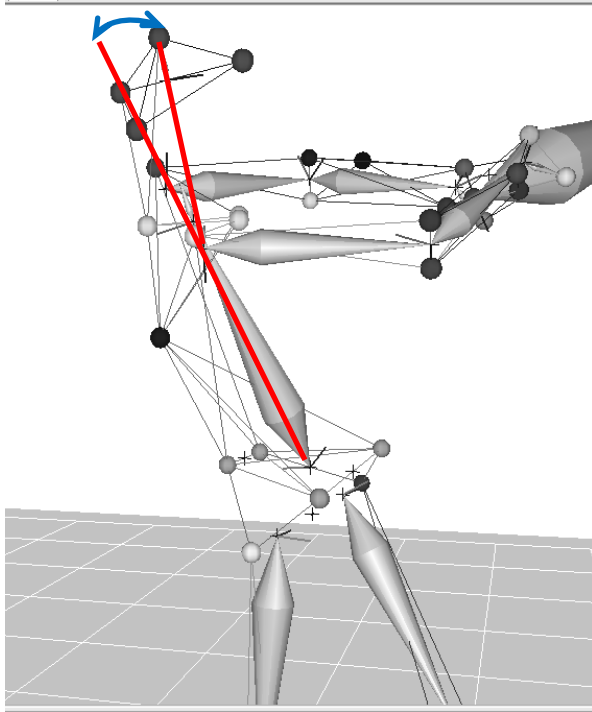

Upper trunk flexion

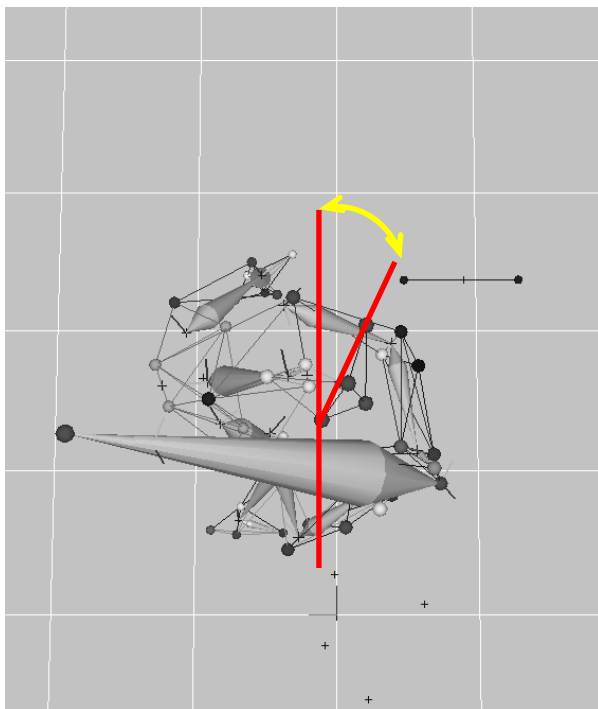

Head rotation

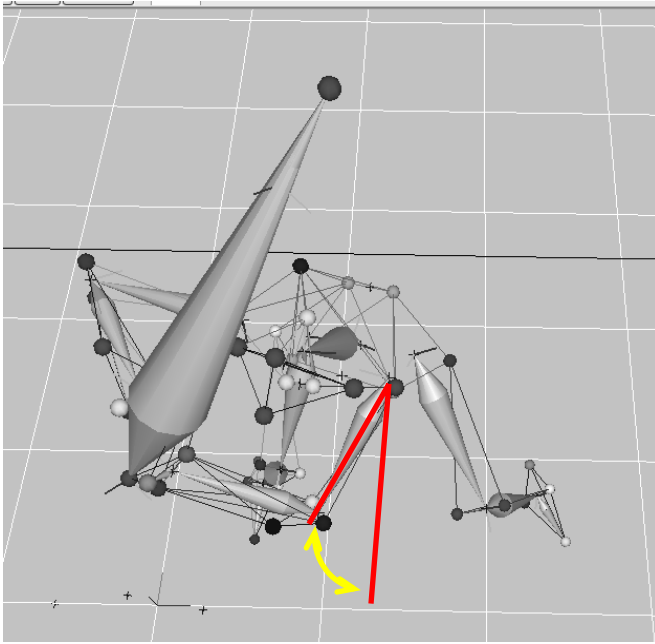

Lead shoulder azimuth

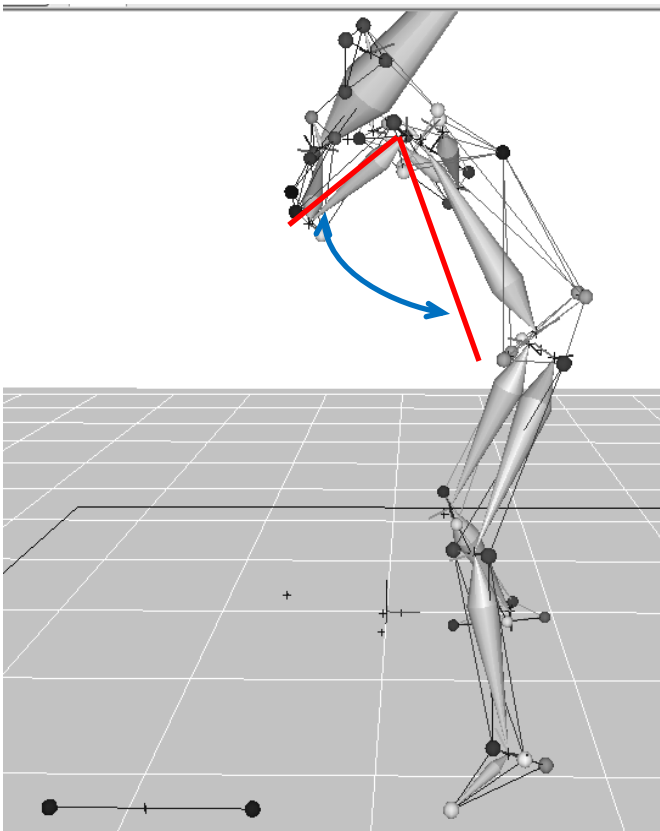

Lead shoulder elevation

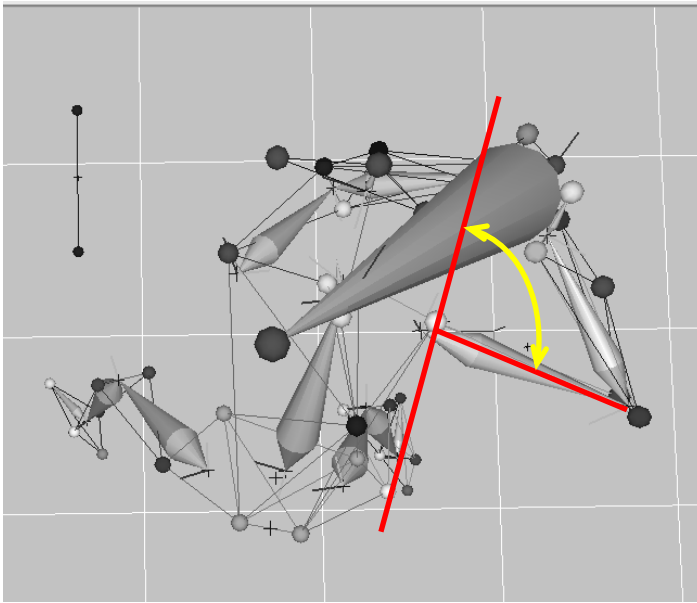

Trail shoulder azimuth

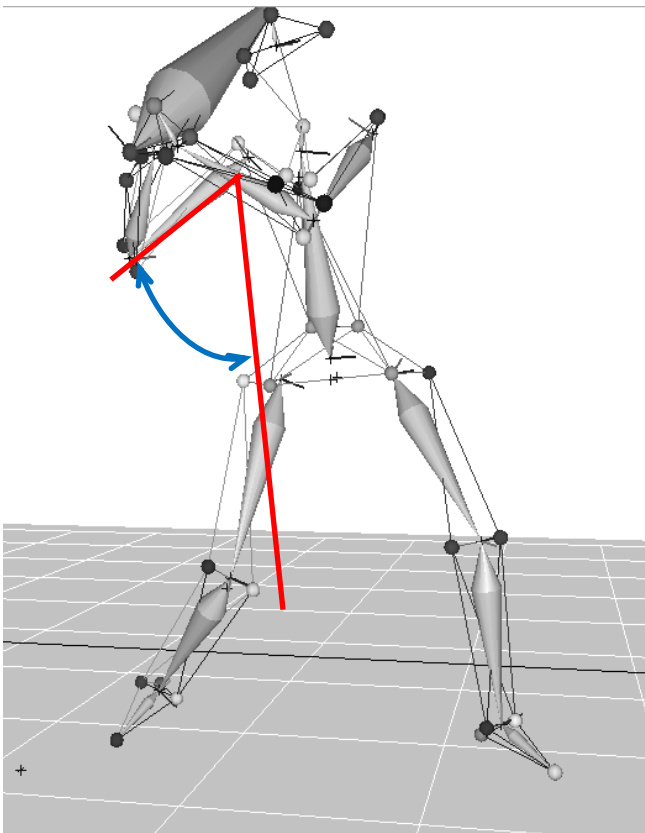

Trail shoulder elevation

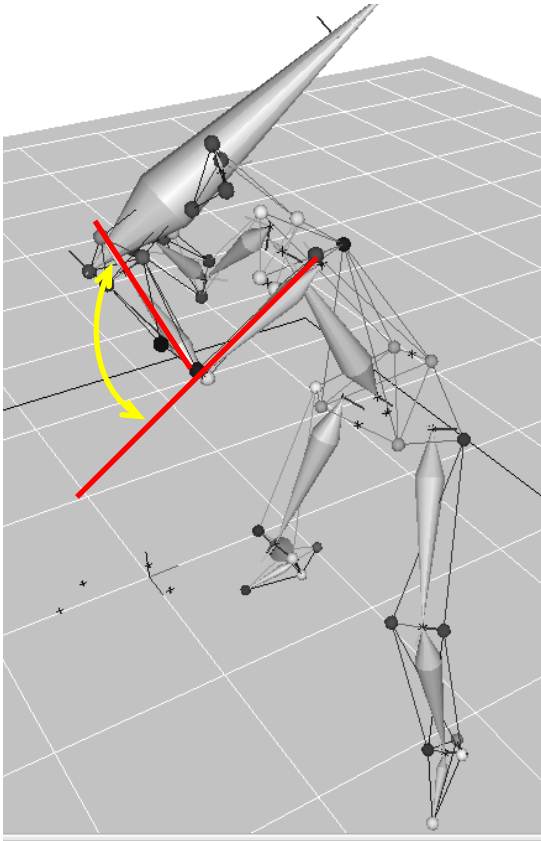

Lead elbow flexion

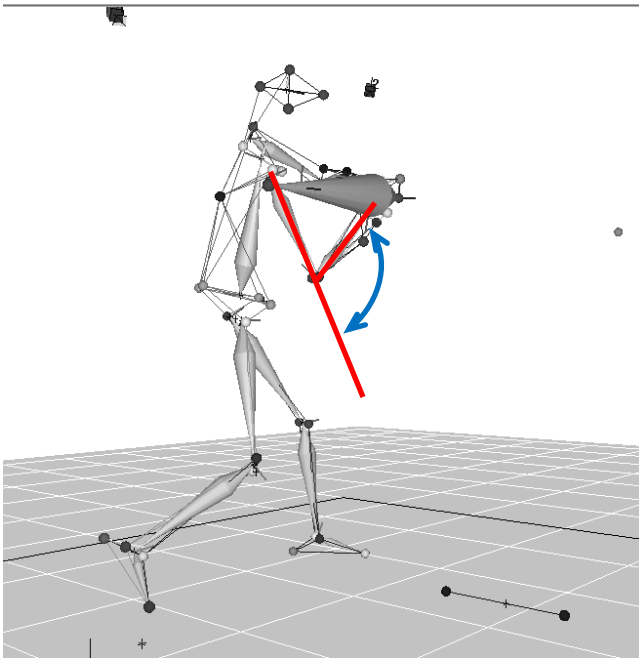

Trail elbow flexion

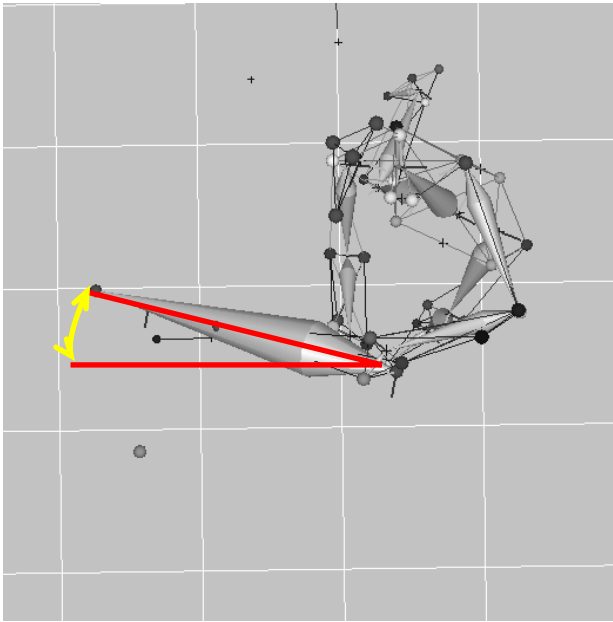

Bat azimuth

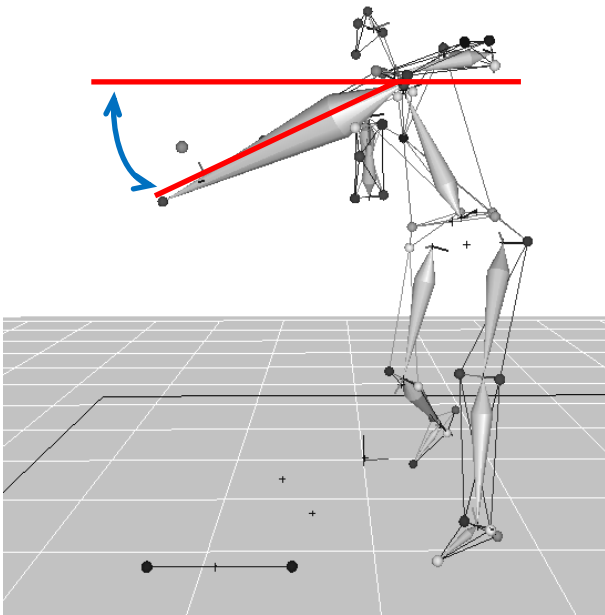

Bat elevation

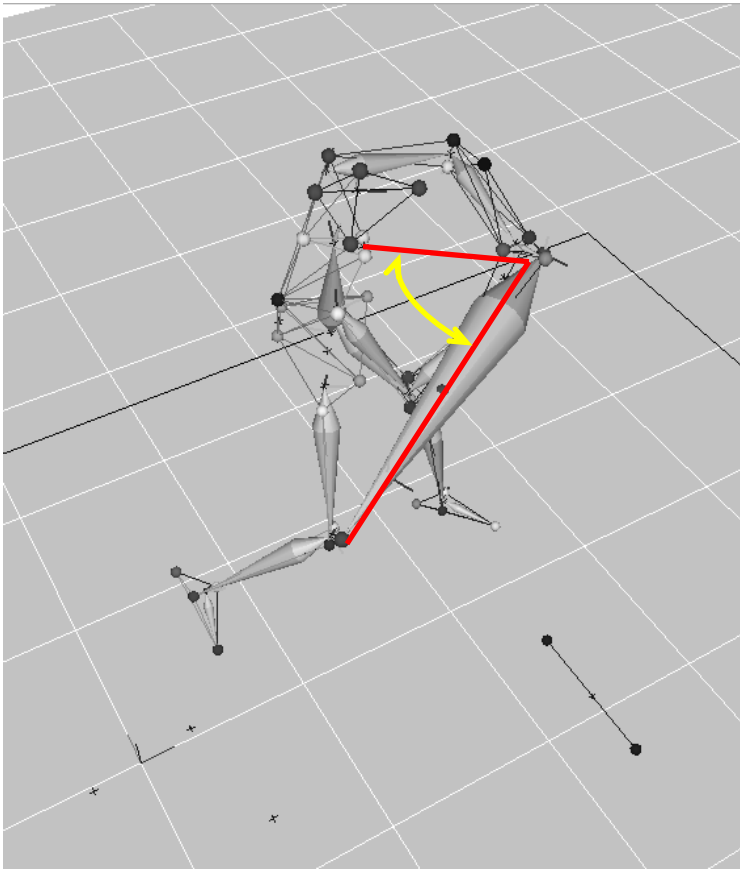

Bat lag

APPENDIX C:  
Motion Analysis Corporation  
Sky Scripts

'TOTAL CALCULATIONS.sky

'Compiles all kinematic calculations and displays one page. For exporting to Excel only.

Sub SkyMain

```

    HeadAngle()
    PelvisJointAngle()
    TrunkAngle()
    PelvisAngularVelocity()
    PolarShoulder()
    ElbowAngle()
    KneeJointAngle()
    FootCalculations()
    BatLag()

```

End Sub

```

*****
*****

```

Sub HeadAngle()

```

    Dim iSegmentHead as Integer
    Dim HPcenter as Integer
    Dim Position(2) as Single
    Dim sPos(2) as Single
    Dim Angles(5) as Single
    Dim Value as Single
    Dim EMPTY as Integer
    Dim RHeelMarker as Integer
    Dim LHeelMarker as Integer
    Dim RHeelMarkerX as Single
    Dim LHeelMarkerX as Single
    Dim sPt(2) as Single

```

```

    iSegmentHead = swModel_GetSegmentIndex("Head")
    HPcenter = swModel_GetMarkerIndex("V_home plate")
    RHeelMarker = swModel_GetMarkerIndex("right heel")
    LHeelMarker = swModel_GetMarkerIndex("left heel")

```

```

    if (iSegmentHead >= 0) then

```

```

        swGetData_SegmentPosition(iSegmentHead, Position)
        swGetData_SegmentAngles(iSegmentHead,
swCortex.RotationOrder.ZXY, Angles)
        swGetData_Marker(HPcenter, sPos)

```



```

Position(0) = (Position(0) - sPos(0))*0.039
Position(1) = (Position(1) - sPos(1))*0.039
Position(2) = (Position(2) - sPos(2))*0.039

```

```

end if

```

```

'Check to see if batter is right-handed or left-handed and plot accordingly.

```

```

swGetData_Marker(RHeelMarker,sPt)
RHeelMarkerX = sPt(0)

```

```

swGetData_Marker(LHeelMarker,sPt)
LHeelMarkerX = sPt(0)

```

```

if (LHeelMarkerX > RHeelMarkerX) then

```

```

'Right-handed batter

```

```

    if (Position(0) = EMPTY) then
        swUserGraphs_SetValue(0, EMPTY)
        swUserGraphs_SetValue(1, EMPTY)
        swUserGraphs_SetValue(2, EMPTY)
        swUserGraphs_SetValue(3, EMPTY)
        swUserGraphs_SetValue(4, EMPTY)
        swUserGraphs_SetValue(5, EMPTY)
    else
        swUserGraphs_SetValue(0, Angles(0)*-1)
        swUserGraphs_SetValue(1, Angles(1)*-1)
        swUserGraphs_SetValue(2, Angles(2)*-1)
        swUserGraphs_SetValue(3, Position(0))
        swUserGraphs_SetValue(4, Position(1))
        swUserGraphs_SetValue(5, Position(2))
    end if

```

```

end if

```

```

else

```

```

'Left-handed batter

```

```

    if (Position(0) = EMPTY) then
        swUserGraphs_SetValue(0, EMPTY)
        swUserGraphs_SetValue(1, EMPTY)
        swUserGraphs_SetValue(2, EMPTY)
        swUserGraphs_SetValue(3, EMPTY)
        swUserGraphs_SetValue(4, EMPTY)
    end if

```

```

        swUserGraphs_SetValue(5, EMPTY)
    else
        swUserGraphs_SetValue(0, Angles(0))
        swUserGraphs_SetValue(1, Angles(1)*-1)
        swUserGraphs_SetValue(2, Angles(2))
        swUserGraphs_SetValue(3, Position(0))
        swUserGraphs_SetValue(4, Position(1)*-1)
        swUserGraphs_SetValue(5, Position(2))
    end if
end if

```

```
end if
```

```
End Sub
```

```

*****
*****

```

```
Sub PelvisJointAngle()
```

```

    Dim iSegmentPelvis as Integer
    Dim sAngles(2) as Single
    Dim Position(2) as Single
    Dim sPos(2) as Single
    Dim RHeelMarker as Integer
    Dim LHeelMarker as Integer
    Dim RHeelMarkerX as Single
    Dim LHeelMarkerX as Single
    Dim sPt(2) as Single

```

```
    Dim EMPTY as Integer
```

```
    iSegmentPelvis = swModel_GetSegmentIndex("Pelvis")
```

```
    HPcenter = swModel_GetMarkerIndex("V_home plate")
```

```
    RHeelMarker = swModel_GetMarkerIndex("right heel")
```

```
    LHeelMarker = swModel_GetMarkerIndex("left heel")
```

```
    if (iSegmentPelvis >= 0) then
```

```

        swGetData_SegmentAngles(iSegmentPelvis,
swCortex.RotationOrder.ZYX, sAngles)
        swGetData_SegmentPosition(iSegmentPelvis, Position)

        swGetData_Marker(HPcenter,sPos)

        Position(0) = (Position(0) - sPos(0))*0.039
        Position(1) = (Position(1) - sPos(1))*0.039
        Position(2) = (Position(2) - sPos(2))*0.039

    end if

'Determine X coordinate of right and left heel markers
swGetData_Marker(RHeelMarker, sPt)
    RHeelMarkerX = sPt(0)
swGetData_Marker(LHeelMarker, sPt)
    LHeelMarkerX = sPt(0)

if (LHeelMarkerX > RHeelMarkerX) then
'Right-handed batter

if (sAngles(0) = 9999999.0) then
    swUserGraphs_SetValue(6, 9999999.0)
    swUserGraphs_SetValue(7, 9999999.0)
    swUserGraphs_SetValue(8, 9999999.0)
    swUserGraphs_SetValue(9, EMPTY)
    swUserGraphs_SetValue(10, EMPTY)
    swUserGraphs_SetValue(11, EMPTY)

    else
        swUserGraphs_SetValue(6, -1*sAngles(0))
        swUserGraphs_SetValue(7, -1*sAngles(1))
        swUserGraphs_SetValue(8, sAngles(2))
        swUserGraphs_SetValue(9, Position(0))
        swUserGraphs_SetValue(10, Position(1))
        swUserGraphs_SetValue(11, Position(2))

    end if

else
'Left-handed batter

```

```

    if (sAngles(0) = 9999999.0) then
        swUserGraphs_SetValue(6, 9999999.0)
        swUserGraphs_SetValue(7, 9999999.0)
        swUserGraphs_SetValue(8, 9999999.0)
        swUserGraphs_SetValue(9, EMPTY)
        swUserGraphs_SetValue(10, EMPTY)
        swUserGraphs_SetValue(11, EMPTY)

    else
        swUserGraphs_SetValue(6, -1*sAngles(0))
        swUserGraphs_SetValue(7, sAngles(1))
        swUserGraphs_SetValue(8, -1*(sAngles(2)+180))
        swUserGraphs_SetValue(9, Position(0))
        swUserGraphs_SetValue(10, Position(1)*-1)
        swUserGraphs_SetValue(11, Position(2))

    end if

end if

end Sub

```

```

*****
*****

```

```

Sub TrunkAngle()

```

```

    Dim iSegmentTrunk as Integer
    Dim iSegmentPelvis as Integer
    Dim GCS as Integer
    Dim gAngles(2) as Single
    Dim lAngles(2) as Single
    Dim Value as Single
    Dim EMPTY as Integer
    Dim RHeelMarker as Integer
    Dim LHeelMarker as Integer
    Dim RHeelMarkerX as Single
    Dim LHeelMarkerX as Single
    Dim sPt(2) as Single

```

```

    EMPTY = 9999999.0

```

```

    iSegmentTrunk = swModel_GetSegmentIndex("UpperTrunk")
    iSegmentPelvis = swModel_GetSegmentIndex("Pelvis")

```

```

RHeelMarker = swModel_GetMarkerIndex("right heel")
LHeelMarker = swModel_GetMarkerIndex("left heel")
GCS = -1

```

```

if (iSegmentTrunk >= 0) then

```

```

    swGetData_SegmentAngles2(iSegmentTrunk, GCS,
swCortex.RotationOrder.ZYX, gAngles)
    swGetData_SegmentAngles(iSegmentTrunk,
swCortex.RotationOrder.ZYX, lAngles)

```

```

end if

```

```

'Determine if batter was left- or right-handed and plot accordingly

```

```

swGetData_Marker(RHeelMarker,sPt)
RHeelMarkerX = sPt(0)
swGetData_Marker(LHeelMarker,sPt)
LHeelMarkerX = sPt(0)

```

```

if (LHeelMarkerX > RHeelMarkerX) then

```

```

'Right-handed batter

```

```

    if (gAngles(0) = EMPTY) then
        swUserGraphs_SetValue(12, EMPTY)
        swUserGraphs_SetValue(13, EMPTY)
        swUserGraphs_SetValue(14, EMPTY)
    else
        swUserGraphs_SetValue(12, lAngles(0))
        swUserGraphs_SetValue(13, lAngles(1)*-1)
        swUserGraphs_SetValue(14, lAngles(2))
    end if

```

```

else

```

```

'Left-handed batter

```

```

    if (gAngles(0) = EMPTY) then

        swUserGraphs_SetValue(12, EMPTY)
        swUserGraphs_SetValue(13, EMPTY)
        swUserGraphs_SetValue(14, EMPTY)
    else
        swUserGraphs_SetValue(12, lAngles(0))

```

```

        swUserGraphs_SetValue(13, lAngles(1))
        swUserGraphs_SetValue(14, lAngles(2)*-1)
    end if

```

```

end if

```

```

End Sub

```

```

*****
*****

```

```

Sub PelvisAngularVelocity()

```

```

    Dim iPelvis as Integer = swModel_GetSegmentIndex("Pelvis")
    Dim iUpperTrunk as Integer = swModel_GetSegmentIndex("UpperTrunk")
    Dim iLHeelMarker as Integer = swModel_GetMarkerIndex("left heel")
    Dim iRHeelMarker as Integer = swModel_GetMarkerIndex("right heel")
    Dim sPAngularVelocity(2) as Single
    Dim sUTAngularVelocity(2) as Single
    Dim sPUTAngularVelocity(2) as Single
    Dim Value as Single
    Dim LHeelMarkerX as Single
    Dim RHeelMarkerX as Single
    Dim sPt(2) as Single

```

```

    Dim PelvisZAngVel as Single

```

```

    Dim UpperTrunkZAngVel as Single

```

```

    Dim PelvisUpperTrunkZAngVel as Single

```

```

    swGetData_SegmentAngularVelocity(iPelvis, sPAngularVelocity)

```

```

    swGetData_SegmentAngularVelocity(iUpperTrunk, sUTAngularVelocity)

```

```

    swGetData_SegmentAngularVelocity2(iUpperTrunk, iPelvis,
sPUTAngularVelocity)

```

```

    swGetData_Marker(iRHeelMarker,sPt)
    RHeelMarkerX = sPt(0)

```

```

swGetData_Marker(iLHeelMarker,sPt)
LHeelMarkerX = sPt(0)

if (LHeelMarkerX > RHeelMarkerX) then

    PelvisZAngVel = sPAngularVelocity(2)
    UpperTrunkZAngVel = sUTAngularVelocity(2)
    PelvisUpperTrunkZAngVel = sPUTAngularVelocity(2)

else

    PelvisZAngVel = sPAngularVelocity(2)*-1
    UpperTrunkZAngVel = sUTAngularVelocity(2)*-1
    PelvisUpperTrunkZAngVel = sPUTAngularVelocity(2)*-1

end if

swUserGraphs_SetValue(15, PelvisZAngVel)

swUserGraphs_SetValue(16, UpperTrunkZAngVel)

```

end Sub

```

*****
*****

```

Sub PolarShoulder()

```

Dim sPt(2) as Single
Dim sLAngles(2) as Single
Dim sRAngles(2) as Single

Dim LeftShoulderX as Single
Dim LeftShoulderY as Single
Dim LeftShoulderZ as Single
Dim LeftElbowX as Single
Dim LeftElbowY as Single
Dim LeftElbowZ as Single
Dim RightShoulderX as Single
Dim RightShoulderY as Single
Dim RightShoulderZ as Single
Dim RightElbowX as Single
Dim RightElbowY as Single
Dim RightElbowZ as Single

```

```
Dim UpperTrunkX as Single
Dim UpperTrunkY as Single
Dim UpperTrunkZ as Single
```

```
Dim LeftUpperArmX as Single
Dim LeftUpperArmY as Single
Dim LeftUpperArmZ as Single
Dim RightUpperArmX as Single
Dim RightUpperArmY as Single
Dim RightUpperArmZ as Single
```

```
Dim Lrho as Single
Dim Ltheta as Single
Dim Lphi as Single
Dim Rrho as Single
Dim Rtheta as Single
Dim Rphi as Single
```

```
Dim LHeelMarkerX as Single
Dim RHeelMarkerX as Single
```

```
Dim iUpperTrunk as Integer = swModel_GetMarkerIndex("V_upper trunk")
Dim iLeftShoulder as Integer =
swModel_GetMarkerIndex("V_L_Shoulder_JC_Trunk")
Dim iLeftElbow as Integer =
swModel_GetMarkerIndex("V_L_Elbow_JC_Trunk")
Dim iRightShoulder as Integer =
swModel_GetMarkerIndex("V_R_Shoulder_JC_Trunk")
Dim iRightElbow as Integer =
swModel_GetMarkerIndex("V_R_Elbow_JC_Trunk")
Dim iLHeelMarker as Integer = swModel_GetMarkerIndex("left heel")
Dim iRHeelMarker as Integer = swModel_GetMarkerIndex("right heel")
```

```
'Get XYZ coordinates for Shoulder and Elbow joint centers
```

```
if iUpperTrunk >= 0 then
```

```
    swGetData_Marker(iUpperTrunk, sPt)
    UpperTrunkX = sPt(0)
    UpperTrunkY = sPt(1)
    UpperTrunkZ = sPt(2)
```

```
end if
```



```

if iLeftShoulder >= 0 then
    swGetData_Marker(iLeftShoulder, sPt)
    LeftShoulderX = sPt(0)
    LeftShoulderY = sPt(1)
    LeftShoulderZ = sPt(2)
end if

```

'Calculate Left Elbow JC position w.r.t. Upper Trunk VM

```

if iLeftElbow >= 0 then
    swGetData_Marker(iLeftElbow, sPt)
    LeftElbowX = sPt(0)
    LeftElbowY = sPt(1)
    LeftElbowZ = sPt(2)
end if

```

```

if iRightShoulder >= 0 then
    swGetData_Marker(iRightShoulder, sPt)
    RightShoulderX = sPt(0)
    RightShoulderY = sPt(1)
    RightShoulderZ = sPt(2)
end if

```

'Calculate Right Elbow JC position w.r.t. Upper Trunk VM

```

if iRightElbow >= 0 then
    swGetData_Marker(iRightElbow, sPt)
    RightElbowX = sPt(0)
    RightElbowY = sPt(1)
    RightElbowZ = sPt(2)
end if

```

'Calculate UpperArm segment lengths

```

LeftUpperArmX = LeftShoulderX - LeftElbowX
LeftUpperArmY = LeftShoulderY - LeftElbowY
LeftUpperArmZ = LeftShoulderZ - LeftElbowZ
RightUpperArmX = RightShoulderX - RightElbowX
RightUpperArmY = RightShoulderY - RightElbowY
RightUpperArmZ = RightShoulderZ - RightElbowZ

```

'Calculate Polar coordinates of UpperArm segments

'Given(x1,y1,z1) and (x2,y2,z2) as shoulder and elbow JC's, respectively

'corresponding (p,o,w) are:

$$p = \sqrt{(x2-x1)^2 + (y2-y1)^2 + (z2-z1)^2}$$

$$o = \arctan((y2-y1)/(x2-x1))$$

$$w = \arctan(\sqrt{(x2-x1)^2 + (y2-y1)^2} / (z2-z1))$$

```

'Left UpperArm
Lrho = (Math.Sqrt(LeftUpperArmX ^ 2 + LeftUpperArmY ^ 2 +
LeftUpperArmZ ^ 2)) / 10
Ltheta = (Math.ACos(LeftUpperArmZ / (Math.Sqrt(LeftUpperArmX ^ 2
+ LeftUpperArmY ^ 2 + LeftUpperArmZ ^ 2)))) * (180/Pi)
Lphi = (Math.ATan2(LeftUpperArmY, LeftUpperArmX)) * (180/Pi)
'Right UpperArm
Rrho = (Math.Sqrt(RightUpperArmX ^ 2 + RightUpperArmY ^ 2 +
RightUpperArmZ ^ 2)) / 10
Rtheta = (Math.ACos(RightUpperArmZ / (Math.Sqrt(RightUpperArmX ^
2 + RightUpperArmY ^ 2 + RightUpperArmZ ^ 2)))) * (180/Pi)
Rphi = (Math.ATan2(RightUpperArmY, RightUpperArmX)) * (180/Pi)

```

'Determine if batter is left-handed or right-handed and graph accordingly.

```

swGetData_Marker(iRHeelMarker,sPt)
RHeelMarkerX = sPt(0)

```

```

swGetData_Marker(iLHeelMarker,sPt)
LHeelMarkerX = sPt(0)

```

```

if (LHeelMarkerX > RHeelMarkerX) then

```

```

    'Right-handed

```

```

        swUserGraphs_SetValue(17, Ltheta)
        swUserGraphs_SetValue(18, Lphi-90)
        swUserGraphs_SetValue(19, Rtheta)
        swUserGraphs_SetValue(20, Rphi-90)

```

```

    else

```

```

        'Left-handed

```

```

        swUserGraphs_SetValue(17, Rtheta)
        swUserGraphs_SetValue(18, -1*Rphi+90)
        swUserGraphs_SetValue(19, Ltheta)
        swUserGraphs_SetValue(20, -1*Lphi+90)

```

```

    end if

```

```

End Sub

```

```

*****

```

\*\*\*\*\*

Sub ElbowAngle()

```

Dim iSegmentLeftForearm as Integer
Dim iSegmentRightForearm as Integer
Dim iSegmentLeftUpperArm as Integer
Dim iSegmentRightUpperArm as Integer
Dim Angles(2) as Single
Dim AngularVelocity(2) as Single
Dim Value as Single
Dim EMPTY as Integer
Dim LeftXEElbowAngle as Single
Dim LeftYEElbowAngle as Single
Dim LeftZEElbowAngle as Single
Dim RightXEElbowAngle as Single
Dim RightYEElbowAngle as Single
Dim RightZEElbowAngle as Single
Dim LeftElbowVelocity as Single
Dim RightElbowVelocity as Single
Dim RHeelMarker as Integer
Dim LHeelMarker as Integer
Dim RHeelMarkerX as Single
Dim LHeelMarkerX as Single
Dim sPt(2) as Single

```

```
EMPTY = 9999999.0
```

```

iSegmentLeftForearm = swModel_GetSegmentIndex("Left Forearm")
iSegmentRightForearm = swModel_GetSegmentIndex("Right Forearm")
iSegmentLeftUpperArm = swModel_GetSegmentIndex("Left Upper Arm")
iSegmentRightUpperArm = swModel_GetSegmentIndex("RightUpperArm")

```

```

RHeelMarker = swModel_GetMarkerIndex("right heel")
LHeelMarker = swModel_GetMarkerIndex("left heel")

```

```
if (iSegmentLeftForearm >= 0) then
```

```

    swGetData_SegmentAngles(iSegmentLeftForearm,
swCortex.RotationOrder.XYZ, Angles)
    LeftXEElbowAngle = Angles(0) * -1

```

```

    swGetData_SegmentAngularVelocity2(iSegmentLeftForearm,
iSegmentLeftUpperArm, AngularVelocity)
    LeftElbowVelocity = AngularVelocity(0)

```

```

end if

if (iSegmentRightForearm >= 0) then

    swGetData_SegmentAngles(iSegmentRightForearm,
swCortex.RotationOrder.XYZ, Angles)
    RightXElbowAngle = Angles(0) * -1

    swGetData_SegmentAngularVelocity2(iSegmentRightForearm,
iSegmentRightUpperArm, AngularVelocity)
    RightElbowVelocity = AngularVelocity(0)

end if

'Determine X coordinate of right and left heel markers
swGetData_Marker(RHeelMarker, sPt)
    RHeelMarkerX = sPt(0)
swGetData_Marker(LHeelMarker, sPt)
    LHeelMarkerX = sPt(0)

'Conditional statement to determine whether subject is right- or left-handed batter
'Data will be graphed depending on handedness of subject
if (LHeelMarkerX > RHeelMarkerX) then
    'Right-handed batter

    if (LeftXElbowAngle = EMPTY) then
        swUserGraphs_SetValue(21, EMPTY)
        swUserGraphs_SetValue(23, EMPTY)
    else
        swUserGraphs_SetValue(21, LeftXElbowAngle)
        swUserGraphs_SetValue(23, LeftElbowVelocity)
    end if

    if (RightXElbowAngle = EMPTY) then
        swUserGraphs_SetValue(22, EMPTY)
        swUserGraphs_SetValue(24, EMPTY)
    else
        swUserGraphs_SetValue(22, RightXElbowAngle)
        swUserGraphs_SetValue(24, RightElbowVelocity)
    end if

else

    'Left-handed batter

```

```

if (LeftXElbowAngle = EMPTY) then
    swUserGraphs_SetValue(22, EMPTY)
    swUserGraphs_SetValue(24, EMPTY)
else
    swUserGraphs_SetValue(22, LeftXElbowAngle)
    swUserGraphs_SetValue(24, LeftElbowVelocity)
end if

if (RightXElbowAngle = EMPTY) then
    swUserGraphs_SetValue(21, EMPTY)
    swUserGraphs_SetValue(23, EMPTY)
else
    swUserGraphs_SetValue(21, RightXElbowAngle)
    swUserGraphs_SetValue(23, RightElbowVelocity)
end if

end if

```

End Sub

```

*****
*****

```

Sub KneeJointAngle()

```

Dim iSegmentLeftShank as Integer
Dim iSegmentRightShank as Integer
Dim iSegmentLeftThigh as Integer
Dim iSegmentRightThigh as Integer
Dim Angles(2) as Single
Dim AngularVelocity(2) as Single
Dim Value as Single
Dim EMPTY as Integer
Dim LeftKneeXAngle as Single
Dim RightKneeXAngle as Single
Dim LeftKneeVelocity as Single
Dim RightKneeVelocity as Single
Dim RHeelMarker as Integer
Dim LHeelMarker as Integer
Dim RHeelMarkerX as Integer
Dim LHeelMarkerX as Integer
Dim sPt(2) as Single

```

```

iSegmentRightShank = swModel_GetSegmentIndex("Right Shank")
iSegmentLeftShank = swModel_GetSegmentIndex("Left Shank")
iSegmentLeftThigh = swModel_GetSegmentIndex("Left Thigh")
iSegmentRightThigh = swModel_GetSegmentIndex("Right Thigh")

```

```

RHeelMarker = swModel_GetMarkerIndex("right heel")
LHeelMarker = swModel_GetMarkerIndex("left heel")
EMPTY = 9999999.0

```

```

'Calculate joint angles
if (iSegmentLeftShank >= 0) then

```

```

    swGetData_SegmentAngles(iSegmentLeftShank,
swCortex.RotationOrder.XYZ, Angles)
    LeftKneeXAngle = Angles(0)

```

```

    swGetData_SegmentAngularVelocity2(iSegmentLeftShank,
iSegmentLeftThigh, AngularVelocity)
    LeftKneeVelocity = AngularVelocity(0)*-1

```

```

end if

```

```

if (iSegmentRightShank >= 0) then

```

```

    swGetData_SegmentAngles(iSegmentRightShank,
swCortex.RotationOrder.XYZ, Angles)
    RightKneeXAngle = Angles(0)

```

```

    swGetData_SegmentAngularVelocity2(iSegmentRightShank,
iSegmentRightThigh, AngularVelocity)
    RightKneeVelocity = AngularVelocity(0)*-1

```

```

end if

```

```

'Determine X coordinate of right and left heel markers

```

```

swGetData_Marker(RHeelMarker, sPt)

```

```

    RHeelMarkerX = sPt(0)

```

```

swGetData_Marker(LHeelMarker, sPt)

```

```

    LHeelMarkerX = sPt(0)

```

```

'Conditional statement to determine whether subject is right- or left-handed batter

```

```

'Data will be graphed depending on handedness of subject

```

```

if LHeelMarkerX > RHeelMarkerX

```

```

    'Right-handed batter

```

```

    if LeftKneeXAngle = EMPTY then
        swUserGraphs_SetValue(25, EMPTY)
        swUserGraphs_SetValue(27, EMPTY)
    else
        swUserGraphs_SetValue(25, LeftKneeXAngle)
        swUserGraphs_SetValue(27, LeftKneeVelocity)
    end if

    if RightKneeXAngle = EMPTY then
        swUserGraphs_SetValue(26, EMPTY)

    else
        swUserGraphs_SetValue(26, RightKneeXAngle)

    end if

else
    'Left-handed batter
    if LeftKneeXAngle = EMPTY then
        swUserGraphs_SetValue(26, EMPTY)

    else
        swUserGraphs_SetValue(26, LeftKneeXAngle)

    end if

    if RightKneeXAngle = EMPTY then
        swUserGraphs_SetValue(25, EMPTY)
        swUserGraphs_SetValue(27, EMPTY)
    else
        swUserGraphs_SetValue(25, RightKneeXAngle)
        swUserGraphs_SetValue(27, RightKneeVelocity)
    end if

end if

End Sub

*****
*****

Sub FootCalculations()

    Dim iMarkerRightAnkle as Single

```

```

Dim iMarkerLeftAnkle as Single
Dim sPt(5) as Single
Dim Value as Single
Dim RightAnkleX as Single
Dim RightAnkleY as Single
Dim RightAnkleZ as Single
Dim LeftAnkleX as Single
Dim LeftAnkleY as Single
Dim LeftAnkleZ as Single
Dim AnkleDistance as Single
Dim iMarkerRightToe as Single
Dim iMarkerLeftToe as Single
Dim iMarkerRightHeel as Single
Dim iMarkerLeftHeel as Single
Dim iSubjectHeight as Single

iMarkerRightAnkle = swModel_GetMarkerIndex("V_right ankle")
iMarkerLeftAnkle = swModel_GetMarkerIndex("V_left ankle")
iMarkerRightToe = swModel_GetMarkerIndex("right toe")
iMarkerLeftToe = swModel_GetMarkerIndex("left toe")
iMarkerRightHeel = swModel_GetMarkerIndex("right heel")
iMarkerLeftHeel = swModel_GetMarkerIndex("left heel")
iSubjectHeight = swGetPersonHeight()

```

```

''''''''''''''''

```

```

' STRIDE LENGTH

```

```

''''''''''''''''

```

```

' Calculate distance between Right and Left Ankle Joint Centers

```

```

' Get position of Right Ankle VM in XYZ directions
if iMarkerRightAnkle >= 0 then

```

```

    swGetData_Marker(iMarkerRightAnkle, sPt)
    RightAnkleX = sPt(0)
    RightAnkleY = sPt(1)

```

```

end if

```

```

' Get position of Left Ankle VM in XYZ directions
if iMarkerLeftAnkle >= 0 then

```

```

    swGetData_Marker(iMarkerLeftAnkle, sPt)
    LeftAnkleX = sPt(0)
    LeftAnkleY = sPt(1)

```



```

end if

' Convert iSubjectHeight from Centimeters to Inches
iSubjectHeight = iSubjectHeight * 0.394

' Calculate distance between Right and Left Ankle VM
AnkleDistance = Math.Sqrt((RightAnkleX - LeftAnkleX) ^ 2 + (RightAnkleY -
LeftAnkleY) ^ 2)
' Convert distance in Millimeters to distance in Inches
AnkleDistance = AnkleDistance * 0.039
' Normalize Stride Distance (in inches) to Subject Height (in inches)
AnkleDistance = 100* AnkleDistance / iSubjectHeight

' Graph Stride Length
swUserGraphs_SetValue(28, AnkleDistance)

.....
'STRIDE DIRECTION (in inches)
.....
' Lead Ankle JC wrt Rear Ankle JC in Y Axis

    Dim LHeelMarker as Single = swModel_GetMarkerIndex("left heel")
    Dim RHeelMarker as Single = swModel_GetMarkerIndex("right heel")
    Dim RightAnkleYInitialPosition as Single = swModel_GetMarkerIndex("V_right
ankle")
    Dim LeftAnkleYInitialPosition as Single = swModel_GetMarkerIndex("V_left
ankle")

'Find position of Right and Left Heel markers on mocap frame 10
swGetData_Marker(LHeelMarker, sPt, 9)
    LHeelMarkerX = sPt(0)
swGetData_Marker(RHeelMarker, sPt, 9)
    RHeelMarkerX = sPt(0)

if (LHeelMarkerX > RHeelMarkerX) then

'Right-handed batter

    if RightAnkleYInitialPosition >= 0 then

        swGetData_Marker(RightAnkleYInitialPosition, sPt, 0)
        RightAnkleYInitialPosition = sPt(1)

```

end if

'Calculate Stride Direction of Lead Ankle w.r.t. Rear Ankle  
 StrideDirectionY = RightAnkleYInitialPosition - LeftAnkleY  
 StrideDirectionY = StrideDirectionY \* 0.039

swUserGraphs\_SetValue(29, StrideDirectionY)

else

'Left-handed batter

if LeftAnkleYInitialPosition >= 0

swGetData\_Marker(LeftAnkleYInitialPosition, sPt, 0)  
 LeftAnkleYInitialPosition = sPt(1)

end if

'Calculate Stride Direction of Lead Ankle w.r.t. Rear Ankle  
 StrideDirectionY = LeftAnkleYInitialPosition - RightAnkleY  
 StrideDirectionY = StrideDirectionY \* 0.039

swUserGraphs\_SetValue(29, -1\*StrideDirectionY)

end if

.....

'LEAD FOOT ANGLE

.....

' Calculate relationship of lead toe to lead ankle w.r.t. X-axis

Dim LengthLeftFoot as Single  
 Dim LengthLeftHeel as Single  
 Dim LengthLeftToe as Single  
 Dim LengthRightFoot as Single  
 Dim LengthRightHeel as Single  
 Dim LengthRightToe as Single  
 Dim LeftToeX as Single  
 Dim LeftToeY as Single  
 Dim RightToeX as Single  
 Dim RightToeY as Single  
 Dim LeftHeelX as Single  
 Dim LeftHeelY as Single  
 Dim RightHeelX as Single  
 Dim RightHeelY as Single

```

Dim DotLeadHeel as Single
Dim DotLeadToe as Single
Dim AngleLeadHeel as Single
Dim AngleLeadToe as Single
Dim LeadFootAngle as Single
Dim DotLeftFoot as Single
Dim AngleLeftFoot as Single
Dim DotRightFoot as Single
Dim AngleRightFoot as Single
Dim XAxisLine as Integer

```

```
XAxisLine = 1
```

```
***Need to put in check to auto calculate right and left batters
```

```
' Get position of Left Toe in XYZ directions
```

```
  if iMarkerRightToe >= 0 then
```

```
    swGetData_Marker(iMarkerRightToe, sPt)
```

```
    RightToeX = sPt(0)
```

```
    RightToeY = sPt(1)
```

```
  end if
```

```
  if iMarkerLeftToe >= 0 then
```

```
    swGetData_Marker(iMarkerLeftToe, sPt)
```

```
    LeftToeX = sPt(0)
```

```
    LeftToeY = sPt(1)
```

```
  end if
```

```
  if iMarkerRightHeel >= 0 then
```

```
    swGetData_Marker(iMarkerRightHeel, sPt)
```

```
    RightHeelX = sPt(0)
```

```
    RightHeelY = sPt(1)
```

```
  end if
```

```
  if iMarkerLeftHeel >= 0 then
```

```
    swGetData_Marker(iMarkerLeftHeel, sPt)
```

```
    LeftHeelX = sPt(0)
```

```
    LeftHeelY = sPt(1)
```

```
  end if
```

```
if (LHeelMarkerX > RHeelMarkerX) then
```

```
'Right-handed batter
```

```
  ' Find length of Lead Foot (Ankle JC -> Toe)
```

```
    ' Vector = <x2 - x1, y2 - y1>
```

```
    ' LengthVector = |<x, y>| = sqrt(x*x + y*y)
```

```
  LengthLeftFoot = Math.Sqrt((LeftHeelX - LeftToeX) ^ 2 + (LeftHeelY - LeftToeY) ^ 2)
```

```
  LengthXAxis = Math.Sqrt((Origin - XAxisLine) ^ 2)
```

```

' Find dot of lead foot (X-axis)
DotLeftFoot = (LeftHeelX - LeftToeX) * (Origin - XAxisLine)

' Find angle of lead foot w.r.t. XAxis (in degrees)
AngleLeftFoot = (Math.ACos(DotLeftFoot / (LengthLeftFoot *
LengthXAxis))) * (180 / Pi)

' Graph foot angle w.r.t. X-axis (in degrees)
swUserGraphs_SetValue(30, AngleLeftFoot)

else

'Left-handed batter

LengthRightFoot = Math.Sqrt((RightHeelX - RightToeX) ^ 2 +
(RightHeelY - RightToeY) ^ 2)
LengthXAxis = Math.Sqrt((Origin - XAxisLine) ^ 2)

DotRightFoot = (RightHeelX - RightToeX) * (Origin - XAxisLine)

AngleRightFoot = (Math.ACos(DotRightFoot / (LengthRightFoot *
LengthXAxis))) * (180 / Pi)

swUserGraphs_SetValue(30, AngleRightFoot)

end if

End Sub

*****
*****

Sub BatLag()

Dim iBatKnob as Integer
Dim iBatCap as Integer
Dim iWrist as Integer
Dim iClavicle as Integer
Dim BatKnob as Single
Dim BatCap as Single
Dim BatTheta as Single
Dim BatPhi as Single
Dim Wrist as Single

```

Dim Clavicle as Single

Dim sPt(2) as Single  
 Dim BatKnobX as Single  
 Dim BatKnobY as Single  
 Dim BatKnobZ as Single  
 Dim BatCapX as Single  
 Dim BatCapY as Single  
 Dim BatCapZ as Single  
 Dim WristX as Single  
 Dim WristY as Single  
 Dim WristZ as Single  
 Dim ClavicleX as Single  
 Dim ClavicleY as Single  
 Dim ClavicleZ as Single  
 Dim LengthBat as Single  
 Dim LengthBatX as Single  
 Dim LengthBatY as Single  
 Dim LengthBatZ as Single  
 Dim LengthWristClavicle as Single  
 Dim LengthWristClavicleX as Single  
 Dim LengthWristClavicleY as Single  
 Dim LengthWristClavicleZ as Single  
 Dim DotBat as Single  
 Dim AngleBatWristClavicle as Single  
 Dim LengthBatIN as Single  
 Dim LengthWristClavicleIN as Single

Dim XEMPTY as Single = 999999

'Get marker and segment indices  
 iBatKnob = swModel\_GetMarkerIndex("bat knob")  
 iBatCap = swModel\_GetMarkerIndex("bat cap")  
 iBatBarrel = swModel\_GetMarkerIndex("V\_bat barrel")  
 iWrist = swModel\_GetMarkerIndex("V\_Mid\_Wrist")  
 iClavicle = swModel\_GetMarkerIndex("V\_clavicle")

'Get marker XYZ coordinates w.r.t. GCS  
 if (iBatKnob >= 0) then  
     swGetData\_Marker(iBatKnob, sPt)  
     BatKnobX = sPt(0)  
     BatKnobY = sPt(1)  
     BatKnobZ = sPt(2)  
 end if  
 if (iBatCap >= 0) then

```

        swGetData_Marker(iBatCap, sPt)
            BatCapX = sPt(0)
            BatCapY = sPt(1)
            BatCapZ = sPt(2)
    end if
    if (iWrist >= 0) then
        swGetData_Marker(iWrist, sPt)
            WristX = sPt(0)
            WristY = sPt(1)
            WristZ = sPt(2)
    end if
    if (iClavicle >= 0) then
        swGetData_Marker(iClavicle, sPt)
            ClavicleX = sPt(0)
            ClavicleY = sPt(1)
            ClavicleZ = sPt(2)
    end if

'Calculate distances in each of three axes
LengthBatX = BatCapX - BatKnobX
LengthBatY = BatCapY - BatKnobY
LengthBatZ = BatCapZ - BatKnobZ
LengthWristClavicleX = ClavicleX - WristX
LengthWristClavicleY = ClavicleY - WristY
LengthWristClavicleZ = ClavicleZ - WristZ

'Find the length of the two vectors used for analysis
'Vector = <x2 - x1, y2 - y1, z2 - z1>
'LengthVector = |<x,y,z>| = sqrt(x*x + y*y + z*z)
LengthBat = Math.Sqrt(LengthBatX ^ 2 + LengthBatY ^ 2 + LengthBatZ ^ 2)
LengthWristClavicle = Math.Sqrt(LengthWristClavicleX ^ 2 +
LengthWristClavicleY ^ 2 + LengthWristClavicleZ ^ 2)

'Find the dot of the bat/angle between vectors
'DotProduct = Ax * Bx + Ay * By + Az * Bz
'Angle between vectors (in degrees) = (ACos(DotProduct / (LengthA *
LengthB))) * (180/Pi)

    DotProduct = LengthBatX * LengthWristClavicleX + LengthBatY *
LengthWristClavicleY + LengthBatZ * LengthWristClavicleZ
    AngleBatWristClavicle = (Math.ACos(DotProduct / (LengthBat *
LengthWristClavicle))) * (180/Pi)

'Convert LengthBat / LengthWristClavicle to inches

```

```

'1mm = 0.039in
LengthBatIN = LengthBat * 0.039
'LengthWristClavicleIN = LengthWristClavicle * 0.039

'Calculate theta (elevation) and phi (azimuth) of bat in global space
BatTheta = (Math.Acos(LengthBatZ / (Math.Sqrt(LengthBatX ^ 2 + LengthBatY
^ 2 + LengthBatZ ^ 2)))) * (180/Pi)
BatPhi = (Math.ATan2(LengthBatY, LengthBatX)) * (180/Pi)

'We need to use the old graph values to make the angles continuous.

Dim lastFrame As Integer = swGetData_FrameNumber() - 1
Dim oldAngle as Single = swGetData_UserGraphs(3, 0, lastFrame)

'If(lastFrame >= 0) Then

'Do 180 degree adjustments until we are close enough
'Dim delta As Single = BatPhi - oldAngle
'While(Math.Abs(delta) > 100) '100 degrees is a semi arbitrary threshold
for determining an angle flip
'BatPhi = BatPhi + Math.Sign(delta) * -180 'move the angle 180
degrees closer
'delta = BatPhi - oldAngle
'End While

'End If

'Determine if batter is left-handed or right-handed and plot accordingly

Dim RHeelMarker as Integer
Dim LHeelMarker as Integer
Dim RHeelMarkerX as Single
Dim LHeelMarkerX as Single

RHeelMarker = swModel_GetMarkerIndex("right heel")
LHeelMarker = swModel_GetMarkerIndex("left heel")

swGetData_Marker(RHeelMarker, sPt)
RHeelMarkerX = sPt(0)

swGetData_Marker(LHeelMarker, sPt)
LHeelMarkerX = sPt(0)

```

```
if (LHeelMarkerX > RHeelMarkerX) then
'Right-handed
    swUserGraphs_SetValue(31, LengthBatIN)
    swUserGraphs_SetValue(32, -1*AngleBatWristClavicle+180)
    swUserGraphs_SetValue(33, -1*BatTheta+90)
    swUserGraphs_SetValue(34, BatPhi-270)

else
'Left-handed
    swUserGraphs_SetValue(31, LengthBatIN)
    swUserGraphs_SetValue(32, -1*AngleBatWristClavicle+180)
    swUserGraphs_SetValue(33, -1*BatTheta+90)
    swUserGraphs_SetValue(34, -1*BatPhi-270)

end if

End Sub
```



```
'ForcePlateInfo.sky
```

```
Sub SkyMain
```

```
    ForcePlateInfo()
```

```
End Sub
```

```
Sub ForcePlateInfo()
```

```
    'Force Platform 1 = swGetData_ForcePlateForces(0,GRF)
```

```
    'Force Platform 2 = swGetData_ForcePlateForces(1,GRF)
```

```
    Dim lfGRF(4) as Single
```

```
    Dim tfGRF(4) as Single
```

```
    Dim EMPTY as Integer
```

```
    Dim SubjectWeight as Single
```

```
    Dim LHeelMarker as Integer
```

```
    Dim RHeelMarker as Integer
```

```
    Dim LHeelMarkerX as Single
```

```
    Dim RHeelMarkerX as Single
```

```
    Dim sPt(2) as Single
```

```
    RHeelMarker = swModel_GetMarkerIndex("right heel")
```

```
    LHeelMarker = swModel_GetMarkerIndex("left heel")
```

```
    EMPTY = 1999999.0
```

```
    SubjectWeight = swGetPersonWeight()
```

```
    SubjectWeight = SubjectWeight * 9.80665
```

```
    'Force Platform 1 (Lead Foot)
```

```
    swGetData_ForcePlateForces(0,lfGRF)
```

```
    'Force Platform 2 (Trail Foot)
```

```
    swGetData_ForcePlateForces(1,tfGRF)
```

```
    lfGRF(0) = 100* lfGRF(0) / SubjectWeight
```

```
    lfGRF(1) = 100* lfGRF(1) / SubjectWeight
```

```
    lfGRF(2) = 100* lfGRF(2) / SubjectWeight
```

```
    tfGRF(0) = 100* tfGRF(0) / SubjectWeight
```

```
    tfGRF(1) = 100* tfGRF(1) / SubjectWeight
```

```
    tfGRF(2) = 100* tfGRF(2) / SubjectWeight
```

```
'Determine if batter is left- or right-handed and plot accordingly
swGetData_Marker(RHeelMarker, sPt)
RHeelMarkerX = sPt(0)
```

```
swGetData_Marker(LHeelMarker, sPt)
LHeelMarkerX = sPt(0)
```

```
if (LHeelMarkerX > RHeelMarkerX) then
```

```
'Right-handed batter
```

```
  if (tfGRF(0) = EMPTY) then
    swUserGraphs_SetValue(0, EMPTY)
    swUserGraphs_SetValue(1, EMPTY)
    swUserGraphs_SetValue(2, EMPTY)
    swUserGraphs_SetValue(3, EMPTY)
    swUserGraphs_SetValue(4, EMPTY)
    swUserGraphs_SetValue(5, EMPTY)
    swUserGraphs_SetValue(6, EMPTY)
    swUserGraphs_SetValue(7, EMPTY)
    swUserGraphs_SetValue(8, EMPTY)
    swUserGraphs_SetValue(9, EMPTY)
  else
    swUserGraphs_SetValue(0, tfGRF(0))
    swUserGraphs_SetValue(1, -1*tfGRF(1))
    swUserGraphs_SetValue(2, tfGRF(2))
    swUserGraphs_SetValue(3, tfGRF(3))
    swUserGraphs_SetValue(4, tfGRF(4))
    swUserGraphs_SetValue(5, lfGRF(0))
    swUserGraphs_SetValue(6, -1*lfGRF(1))
    swUserGraphs_SetValue(7, lfGRF(2))
    swUserGraphs_SetValue(8, lfGRF(3))
    swUserGraphs_SetValue(9, lfGRF(4))
  end if
```

```
else
```

```
'Left-handed batter
```

```
  if (tfGRF(0) = EMPTY) then
    swUserGraphs_SetValue(0, EMPTY)
    swUserGraphs_SetValue(1, EMPTY)
    swUserGraphs_SetValue(2, EMPTY)
```

```
swUserGraphs_SetValue(3, EMPTY)
swUserGraphs_SetValue(4, EMPTY)
swUserGraphs_SetValue(5, EMPTY)
swUserGraphs_SetValue(6, EMPTY)
swUserGraphs_SetValue(7, EMPTY)
swUserGraphs_SetValue(8, EMPTY)
swUserGraphs_SetValue(9, EMPTY)
else
swUserGraphs_SetValue(0, tfGRF(0))
swUserGraphs_SetValue(1, tfGRF(1))
swUserGraphs_SetValue(2, tfGRF(2))
swUserGraphs_SetValue(3, tfGRF(3))
swUserGraphs_SetValue(4, tfGRF(4))
swUserGraphs_SetValue(5, lfGRF(0))
swUserGraphs_SetValue(6, lfGRF(1))
swUserGraphs_SetValue(7, lfGRF(2))
swUserGraphs_SetValue(8, lfGRF(3))
swUserGraphs_SetValue(9, lfGRF(4))
end if

end if

End Sub
```

APPENDIX D:  
MATLAB Programming Codes

```

%complete_baseball.m
%This MATLAB program is used to concatenate kinematic and force plate data
%files, calculate lead shoulder and bat azimuth velocities, extract data
%from 4 key events (Lead Foot Off, Lead Foot Down, Lead Foot Commit, Ball
%Contact) and maximum values of selected variables

%A file of the combined kinematic and force plate data for each trial, and
%a subject file is created/appended with one row for each trial

clear; clc

prompt1 = {'Please enter the 6-digit subject ID'};
subjectid = inputdlg(prompt1);

prompt2 = {'Please enter trial number (9999 to exit)'};
dg_title = 'tn';
num_lines = 1;
default = {'9999'};
trial_num = inputdlg(prompt2,dg_title,num_lines,default);
trial_nمبر = str2double(trial_num{1,1});

while trial_nمبر~=9999
    %Read in kinematic data file and assigns trial number variable
    battingFile = strcat(subjectid, '-',trial_num,'.data');
    batFile = cell2mat(battingFile);
    c=dlmread(batFile, '\t',3,0);

    %Read in force plate data file
    forcesFile = strcat(subjectid, '-',trial_num,'-forces','.data');
    forceFile = cell2mat(forcesFile);
    f=dlmread(forceFile, '\t',3,1);

    %Read in speed file
    speedFile = strcat(subjectid, '-',trial_num,'-speed','.ts');
    spdFile = cell2mat(speedFile);
    aa = dlmread(spdFile, '\t', 6, 19);

    %Read in subject and trial info from Ball Tracking file
    subjectid_string = cell2mat(subjectid);
    [num text raw] = xlsread('Ball tracking.xlsx', subjectid_string);
    trial_index = trial_nمبر+8;
    ballContact = raw(trial_index, 4);

```

```

ballContact = cell2mat(ballContact);
ballLocation = raw(trial_index, 3);
ballLocation = cell2mat(ballLocation);
bcf = {ballContact, ballLocation};
ball_vel_in = raw(trial_index, 2);
ball_vel_out = raw(trial_index, 5);
if (strcmp(ball_vel_out,'MISS') || strcmp(ball_vel_out,'FOUL'))
    hit_result = cell2mat(ball_vel_out);
else
    hit_result = 'HIT';
end;

%Create data arrays
index=c(:,1);
data=c(:,2:end);
forceData=f(:,1:end);
matArray=[index data];

%Ask user for frame of ball contact and pitch type / location
prompt = {'Lead Foot Off (<10% BW):', 'Lead Foot Down (>10% BW):', 'Lead Foot
Commit (>=50% BW):'};
dlg_title = 'Trial Info';
def = {'Y', 'Y', 'Y'};
answer = inputdlg(prompt,dlg_title,num_lines,def);
FootOff=answer{1,1};
FootDown=answer{2,1};
FootCommit=answer{3,1};

%Concatenate trial number, ball location, and hit result
trialinfo = {trial_nmbr ballLocation hit_result};

%Create time column
timecol=zeros(size(matArray,1),1);
x=find(matArray(:,1)==ballContact);
n=x;
frameSpeed=0;
frameCounter=10/3;
for n=n:size(timecol)
    timecol(n)=timecol(n)+frameSpeed;
    frameSpeed=frameSpeed+frameCounter;
    n=n+1;
end;
y=x;

```

```

frameSpeed=0;
while y>0
    timecol(y)=timecol(y)-frameSpeed;
    frameSpeed=frameSpeed+frameCounter;
    y=y-1;
end;
array=[matArray(:,1) timecol matArray(:,2:end)];

%Replace '9999999' with NaN
array(array==9999999)=NaN;

%Create new variable column for Lead Shldr Azim Vel
LeadShoulderAzAngVel=NaN(size(matArray,1),1);
for w=2:size(LeadShoulderAzAngVel)-1
    LeadShoulderAzAngVel(w)=(array(w+1,21)-array(w-1,21))*150;
    w=w+1;
end;
t=2;

%Continuity adjustment for Bat Azimuth angle
while t<=size(array,1)
    if abs(array(t,37)-array(t-1,37))>100
        array(t:end,37)=array(t:end,37)+360;
    end;
    t=t+1;
end

%Create new variable column for Bat Azim Vel
BatAzAngVel=NaN(size(matArray,1),1);
w=2;
for w=2:size(BatAzAngVel)-1
    BatAzAngVel(w)=(array(w+1,37)-array(w-1,37))*150;
    w=w+1;
end;

%Recompose final data array
finalArray=[array(:,1:21) LeadShoulderAzAngVel array(:,22:end) BatAzAngVel
forceData];

%Convert "finalArray" to cell array
dataArray = num2cell(finalArray);

%Create subject file, and write out headers to appropriate Excel sheet
subjfile=batFile(1:6);

```

```

subjectfile=[subjfile 'data' '.xlsx'];
sheetnames = {'Event frames', 'Lead Foot Off', 'Lead Foot Down', 'Lead Foot Commit',
'Ball Contact', 'Maximums'};
xlsheets(sheetnames,subjectfile);
[d1 e1 f1] = xlsread(subjectfile,5);
[sample_row, sample_column] = size(f1);
myheader= {'Frame #' 'Time' 'Head Angle X' 'Head Angle Y'   'Head Angle Z'
           'Head Pos X' 'Head Pos Y' 'Head Pos Z'   'Pelvis Tilt'   'Pelvis Obliq' 'Pelvis
Rot'   'Pelvis Pos X' 'Pelvis Pos Y' 'Pelvis Pos Z' 'UT Flexion'  'UT Lat Flexion'
           'UT Rot'      'Pelvis Rot Vel'      'UT Rot Vel'  'Lead Shldr Elev'   'Lead
Shldr Azim'  'Lead Shldr Azim Vel' 'Trail Shldr Elev'   'Trail Shldr Azim'   'Lead
Elbow' 'Trail Elbow'  'Lead Elbow Vel'   'Trail Elbow Vel'   'Lead Knee'  'Trail
Knee'  'Lead Knee Vel'      'Stride Length' 'Stride Direction'   'Lead Foot Angle'
           'Bat Length'  'Bat Lag' 'Bat Elevation'      'Bat Azimuth' 'Bat Azimuth Vel'
'Trail Foot GRFx'   'Trail Foot GRFy'   'Trail Foot GRFz' 'Trail Foot COPx' 'Trail
Foot COPY'  'Lead Foot GRFx'   'Lead Foot GRFy'   'Lead Foot GRFz' 'Lead Foot
COPx' 'Lead Foot COPY'};
if sample_row<2
    theheader = ['Trial', 'Ball Location', 'Hit Result', myheader];
    xlsappend(subjectfile, theheader, 'Lead Foot Off');
    xlsappend(subjectfile, theheader, 'Lead Foot Down');
    xlsappend(subjectfile, theheader, 'Lead Foot Commit');
    xlsappend(subjectfile, theheader, 'Ball Contact');
end;

%Write out data from Lead Foot Off frame line to appropriate Excel sheet of
%subject file
if FootOff=='Y'
    FootOffGRF=cell2mat(DataArray(1,47));
    i=1;
    while (FootOffGRF>10.0)
        i=i+1;
        FootOffGRF=cell2mat(DataArray(i,47));
    end;
    FootOffdata = [trialinfo, DataArray(i,:)];
    xlsappend(subjectfile, FootOffdata, 'Lead Foot Off');
end;

%Write out data from Lead Foot Down frame line to appropriate Excel sheet
%of subject file
j=1;
if FootDown=='Y'
    if FootOff=='Y'
        j=i+1;
    end;
end;

```



```

FootDownGRF=cell2mat(DataArray(j,47));
while (FootDownGRF<10.0)
    j=j+1;
    FootDownGRF=cell2mat(DataArray(j,47));
end;
FootDowndata = [trialinfo, DataArray(j,:)];
xlsappend(subjectfile, FootDowndata, 'Lead Foot Down');
end;

%Write out data from Lead Foot Commit frame line to appropriate Excel sheet
%of subject file
k=1;
if FootCommit=='Y'
    if FootDown=='Y'
        k=j+1;
    end;
    FootCommitGRF=cell2mat(DataArray(k,47));
    while (FootCommitGRF<50.0)
        k=k+1;
        FootCommitGRF=cell2mat(DataArray(k,47));
    end;
    FootCommitdata = [trialinfo, DataArray(k,:)];
    xlsappend(subjectfile, FootCommitdata, 'Lead Foot Commit');
end;

%Write out data from Ball Contact frame line to appropriate Excel sheet of
%subject file
BallContactdata = [trialinfo, DataArray(ballContact,:)];
xlsappend(subjectfile, BallContactdata, 'Ball Contact');

%Write out all key frames for storage on subject file
key_frames_header = {'Trial' 'Location' 'Hit Result' 'Lead Foot Off' 'Lead Foot Down',
'Lead Foot Commit', 'Ball Contact'};
if sample_row<2
    xlsappend(subjectfile, key_frames_header, 'Event frames');
end;
frame_line = {trial_nمبر ballLocation hit_result i j k ballContact};
xlsappend(subjectfile, frame_line, 'Event frames');

%Create header for maxima and minima worksheet
maxmin_header = {' ', ' ', ' ', 'Pelvis Rotation', ' ', 'UT Rotation', ' ', 'Lead Shldr Azim
Pre-contact', ' ', 'Lead Shldr Azim Post-contact', ' ', 'Trail Elbow', ' ', 'Lead Knee', ' ', 'Bat
Azimuth', ' ', 'Ball Speed', ' ', 'Bat Linear', ' ', 'Trail Foot GRFx', ' ', 'Trail Foot GRFy', ' ',
'Trail Foot GRFz', ' ', 'Lead Foot GRFx', ' ', 'Lead Foot GRFy', ' ', 'Lead Foot GRFz', ' '};

```

```

    'Trial', 'Location', 'Hit Result', 'time', 'speed','time', 'speed','time', 'speed','time',
'speed','time', 'speed','time', 'speed','time', 'speed','Incoming', 'Outgoing', 'time',
'speed','time', 'value','time', 'value','time', 'value','time', 'value','time', 'value','time', 'value'};
    if sample_row<2
        xlsappend(subjectfile, maxmin_header, 'Maximums');
    end;

    %Locate maximum pelvis rotation velocity and index
    [max_pelvis max_pelvis_index] = max(finalArray(:,18));
    max_pelvis_index = timecol(max_pelvis_index,1);

    %Locate maximum upper trunk rotation velocity and index
    [max_ut max_ut_index] = max(finalArray(:,19));
    max_ut_index = timecol(max_ut_index,1);

    %Locate maximum lead shoulder azimuth velocity (pre-contact) and index
    [max_shldr_azim_prec max_shldr_azim_prec_index] =
max(finalArray(1:ballContact,22));
    max_shldr_azim_prec_index = timecol(max_shldr_azim_prec_index,1);

    %Locate maximum lead shoulder azimuth velocity (post-contact) and index
    [max_shldr_azim_postc max_shldr_azim_postc_index] =
max(finalArray(ballContact:end,22));
    max_shldr_azim_postc_index = timecol(max_shldr_azim_postc_index + ballContact-
1,1);

    %Locate maximum trail elbow velocity and index
    [max_elbow max_elbow_index] = max(finalArray(:,28));
    max_elbow_index = timecol(max_elbow_index,1);

    %Locate maximum lead knee extension velocity and index
    [max_knee max_knee_index] = min(finalArray(:,31));
    max_knee_index = timecol(max_knee_index,1);

    %Locate maximum bat azimuth velocity and index
    [max_bat_azim max_bat_azim_index] = max(finalArray(:,39));
    max_bat_azim_index = timecol(max_bat_azim_index,1);

    %Locate maximum bat linear velocity and index
    bat_linear = (aa(:,1));
    [max_bat_linear max_bat_linear_index] = max(bat_linear);
    max_bat_linear = max_bat_linear/1000;
    max_bat_linear_index = timecol(max_bat_linear_index,1);

    %Locate maximum Trail Foot GRFx and index
    [TF_GRFx TF_GRFx_index] = max(finalArray(1:ballContact,40));

```

```

TF_GRFx_index = timecol(TF_GRFx_index,1);

%Locate maximum Trail Foot GRFy and index
[TF_GRFy TF_GRFy_index] = max(finalArray(1:ballContact,41));
TF_GRFy_index = timecol(TF_GRFy_index,1);

%Locate maximum Trail Foot GRFz and index
[TF_GRFz TF_GRFz_index] = max(finalArray(1:ballContact,42));
TF_GRFz_index = timecol(TF_GRFz_index,1);

%Locate maximum Lead Foot GRFx and index
[LF_GRFx LF_GRFx_index] = min(finalArray(1:ballContact,45));
LF_GRFx_index = timecol(LF_GRFx_index,1);

%Locate maximum Trail Foot GRFy and index
[LF_GRFy LF_GRFy_index] = min(finalArray(1:ballContact,46));
LF_GRFy_index = timecol(LF_GRFy_index,1);

%Locate maximum Trail Foot GRFz and index
[LF_GRFz LF_GRFz_index] = max(finalArray(1:ballContact,47));
LF_GRFz_index = timecol(LF_GRFz_index,1);

%Write out maxima/minima data to appropriate Excel sheet of subject file
Maximumdata = [trialinfo, max_pelvis_index, max_pelvis, max_ut_index, max_ut,
max_shldr_azim_prec_index, max_shldr_azim_prec, max_shldr_azim_postc_index,
max_shldr_azim_postc, max_elbow_index, max_elbow, max_knee_index, max_knee,
max_bat_azim_index, max_bat_azim, ball_vel_in, ball_vel_out, max_bat_linear_index,
max_bat_linear, TF_GRFx_index, TF_GRFx, TF_GRFy_index, TF_GRFy,
TF_GRFz_index, TF_GRFz, LF_GRFx_index, LF_GRFx, LF_GRFy_index, LF_GRFy,
LF_GRFz_index, LF_GRFz];
xlsappend(subjectfile, Maximumdata, 'Maximums');

%Ask user to create file name and write out combined data file
combinedfilename = strep(forceFile, 'forces.data', 'combined');
combinedfilename = strcat (combinedfilename, '.xlsx');
%[CombinedFile, CombinedPath] = uinputfile('* .xlsx', 'Name the biomechanical data
file to save:', combinedfilename);
xlswrite(finalArray, bcf, myheader, combinedfilename);

prompter = {'Please enter trial number (9999 to exit)'};
trial_num = inputdlg(prompter,dg_title,num_lines,default);
trial_nmbr = str2double(trial_num{1,1});

end;

```

```

%graph_constructor.m
% This program extracts data for the purpose of making graphs

clear; clc

%Prompt user for subject and desired pitch type
prompt1 = {'6-digit subject ID', 'Pitch Type'};
answers = inputdlg(prompt1);
subjectid = answers{1,1};
pitch_type = answers{2,1};

%header = {subjectid, pitch_type};

%Create initial 3 dimensional array of zeros as placeholders
DataArray = NaN(901,19,47);
DataArray(1,1,:) = -2000;
counter=10/3;
for n=2:901
    DataArray(n,1,:) = DataArray(n-1,1,:)+counter;
end;

%Create graphing file for desired pitch type
sheetnames = {'Head Angle X' 'Head Angle Y'      'Head Angle Z'      'Head Pos X'
              'Head Pos Y' 'Head Pos Z'      'Pelvis Tilt'      'Pelvis Obliq' 'Pelvis Rot'      'Pelvis
Pos X' 'Pelvis Pos Y' 'Pelvis Pos Z' 'UT Flexion'  'UT Lat Flexion'      'UT Rot'
              'Pelvis Rot Vel'      'UT Rot Vel' 'Lead Shldr Elev'      'Lead Shldr Azim'
              'Lead Shldr Azim Vel' 'Trail Shldr Elev'      'Trail Shldr Azim'      'Lead Elbow'
              'Trail Elbow' 'Lead Elbow Vel'      'Trail Elbow Vel'      'Lead Knee' 'Trail
Knee' 'Lead Knee Vel'      'Stride Length' 'Stride Direction'      'Lead Foot Angle'
              'Bat Length'  'Bat Lag' 'Bat Elevation'      'Bat Azimuth' 'Bat Azimuth Vel'
              'Trail Foot GRFx'      'Trail Foot GRFy'      'Trail Foot GRFz' 'Trail Foot COPx' 'Trail
Foot COPY' 'Lead Foot GRFx'      'Lead Foot GRFy'      'Lead Foot GRFz' 'Lead Foot
COPx' 'Lead Foot COPY'};
filename = [subjectid '-graphs-' pitch_type '.xlsx'];
fullfilename = fullpath(filename);
xlsheets(sheetnames, fullfilename);

%Prompt for initial trial number
prompt2 = {'Please enter trial number (9999 to exit)'};
dg_title = 'tn';
num_lines = 1;
default = {'9999'};
trial_nmbr = inputdlg(prompt2,dg_title,num_lines,default);
trial_num = str2double(trial_nmbr{1,1});

%Initialize column counter and column header

```

```

column_count = 2;
column_names = cell(1, 19);

while trial_num~=9999
    %Read in trial data
    trial_number = num2str(trial_num);
    combinedFile = [subjectid '-' trial_number '-combined.xlsx'];
    [num text raw] = xlsread(combinedFile);
    BallContactIndex = find(num(:,2) == 0);
    StartIndex = 605-BallContactIndex;
    sizenm = size(num);
    sizenum = sizenm(1,1);
    EndIndex = StartIndex+sizenum-4;

    for i=1:47
        count=4;
        for TimeIndex=StartIndex:EndIndex
            DataArray(TimeIndex,column_count,i) = num(count,i+2);
            count = count+1;
        end;
    end;

    column_id = ['Trial ' trial_number];
    column_names(1, column_count) = {column_id};

    column_count = column_count+1;

    prompter = {'Please enter trial number (9999 to exit)'};
    trial_nmbr = inputdlg(prompter,dg_title,num_lines,default);
    trial_num = str2double(trial_nmbr{1,1});

end;

for j=1:47
    for n=1:901
        nom=0;
        denom=0;
        for p=2:column_count-1
            if isfinite(DataArray(n,p,j))
                nom = nom+DataArray(n,p,j);
                denom = denom+1;
            end;
        end;
    end;
end;

```

```

        DataArray(n,18,j) = nom / denom;
        DataArray(n,17,j) = DataArray(n,18,j) - std(DataArray(n,2:column_count-1,j));
        DataArray(n,19,j) = DataArray(n,18,j) + std(DataArray(n,2:column_count-1,j));
    end;
end;

column_names(1,17) = {'-1 SD'};
column_names(1,18) = {'MEAN'};
column_names(1,19) = {'+1 SD'};

%Create header for output file
header = cell(3,19);
header(1:2,1) = answers;
header(3,1:19) = column_names;

%Open ActiveX for speedy processing
Excel = actxserver('Excel.Application');

%Open created output file
ExcelWorkbook = Excel.workbooks.Open(fullfilename);

for k=1:47
    xlswrite2007(fullfilename, header, k, 'A1:S3');
    xlswrite2007(fullfilename, DataArray(:,k),k,'A4:S904')
end;

%Save and close output file
ExcelWorkbook.Save
ExcelWorkbook.Close(false)
Excel.Quit;
delete(Excel);

%Move file to appropriate destination
newfilelocation = ['C:\Batting calculations\export data\' pitch_type];
copyfile(fullfilename, newfilelocation);

disp('Done');

```

```

%graph_compiler.m
%Compiles data for all subjects for a given pitch type & result

clear; clc

%Prompt user for pitch type / location
prompt1 = {'Enter Pitch Type / Location'};
answ = inputdlg(prompt1);
answer = cell2mat(answ);

%Create file for data storage
sheetnames = {'Head Angle X' 'Head Angle Y'      'Head Angle Z'      'Head Pos X'
              'Head Pos Y' 'Head Pos Z'      'Pelvis Tilt'      'Pelvis Obliq' 'Pelvis Rot'      'Pelvis
Pos X' 'Pelvis Pos Y' 'Pelvis Pos Z' 'UT Flexion'  'UT Lat Flexion'      'UT Rot'
              'Pelvis Rot Vel'      'UT Rot Vel' 'Lead Shldr Elev'      'Lead Shldr Azim'
              'Lead Shldr Azim Vel' 'Trail Shldr Elev'      'Trail Shldr Azim'      'Lead Elbow'
              'Trail Elbow' 'Lead Elbow Vel'      'Trail Elbow Vel'      'Lead Knee' 'Trail
Knee' 'Lead Knee Vel'      'Stride Length' 'Stride Direction'      'Lead Foot Angle'
              'Bat Length' 'Bat Lag' 'Bat Elevation'      'Bat Azimuth' 'Bat Azimuth Vel'
              'Trail Foot GRFx'      'Trail Foot GRFy'      'Trail Foot GRFz' 'Trail Foot COPx' 'Trail
Foot COPY'      'Lead Foot GRFx'      'Lead Foot GRFy'      'Lead Foot GRFz' 'Lead Foot
COPx' 'Lead Foot COPY'};
filename = ['All Subjects - ' answer '.xlsx'];
fullfilename = fullpath(filename);
xlsheets(sheetnames, fullfilename);

%Create cell array for column headers
column_head = cell(1,40);
column_head(1,1) = {'Time'};
column_head(1,2:34) = {'ck2626', 'ec2629', 'kk2631', 'my2632', 'jc2633', 'pb2634',
'jc2635', 'kk2636', 'sc2644', 'js2645', 'mh2647', 'pc2648', 'cr2649', 'rs2650', 'ef2651',
'mf2656', 'cc2657', 'jh2658', 'da2659', 'dd2662', 'jm2663', 'rc2664', 'rc2665', 'lc2670',
'hc2671', 'jg2672', 'jd2673', 'lp2789', 'bl2791', 'jw2795', 'md2802', 'ar2803', 'dl2805'};

%Pre-allocate large array of NaNs
GroupArray = NaN(901,40,47);

%Add time columns for all variables
GroupArray(1,1,:) = -2000;
counter = 10/3;
for n=2:901
    GroupArray(n,1,:) = GroupArray(n-1,1,:)+counter;
end;

```

```

indivIndex=1;
subject_col=1;

count=0;

for subject_col=2:34
    the_subject=cell2mat(column_head(1,subject_col));
    indivFile = [the_subject '-graphs-' answer '.xlsx'];

    realfile = fullpath(indivFile);

    if exist(realfile,'file')
        count = count+1;
        %Read in data from each sheet/variable using ActiveX

        Excel = actxserver('Excel.Application');
        Excel.Workbooks.Open(realfile);
        for i=1:47
            [num, text, ~] = xlsread1(realfile,i,'A4:S904');

            for j=1:901
                %Add subject's average data into his column in the array
                GroupArray(j,subject_col,i) = num(j,18);
            end;
        end;

        Excel.Quit
        Excel.delete
        clear Excel
        disp(the_subject);
    end;
end;

%Open ActiveX for speedy processing
Excel = actxserver('Excel.Application');

%Open created output file
ExcelWorkbook = Excel.workbooks.Open(fullfilename);

for k=1:47
    xlswrite2007(fullfilename, column_head, k, 'A1:AN1');
    xlswrite2007(fullfilename, GroupArray(:,k), k, 'A2');
end;

%Save and close output file
ExcelWorkbook.Save

```



```
ExcelWorkbook.Close(false)  
Excel.Quit;  
delete(Excel);
```

```
disp(count);  
disp('Done');
```

APPENDIX E:  
Graphs of biomechanical data for the  
“typical” professional batter

